

SEIKO

DIGITAL QUARTZ

Cal. M354A

PARTS LIST

Cal. M354A

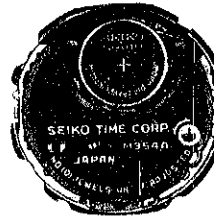
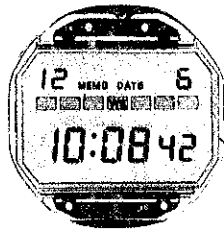

354 941



383 940



389 940

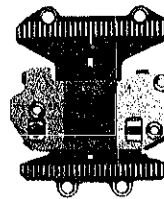

4007 850

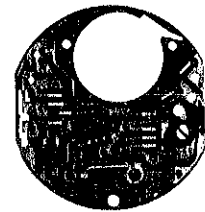

4009 850



4032 940



4050 852



4219 940



4242 941



4256 940



4270 940



4277 940



4282 850



4282 851



4313 850



4313 851

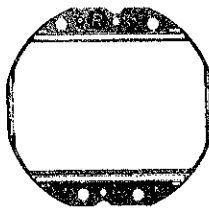

4398 850

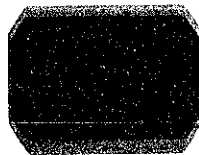

4510 850

4521 540



4540 850



Maxell SR1130W

022 256 $\frac{3}{4}$

Cal. M354A

Characteristics

Casing diameter: 27.0 mm
 Maximum height: 6.4 mm without battery
 Frequency of quartz crystal oscillator: 32,768 Hz (Hz=Hertz Cycle per second)
 Liquid crystal driving system: 2-layer panel multiplex driving system
 Time functions: Digital Display System showing hour, minute, second, month, date and day of the week in 12-hour indication or 24-hour indication.
 Calendar functions: Digital Display System showing calendar, month and year.
 Calendar is displayed for 80 years from January, 1930 to December, 2009.
 Date memory functions: "MEMO" mark is displayed and starts flashing on the designated day.
 Display medium: Nematic Liquid Crystal, FE-Mode
 Time micro adjustor: Trimmer condenser system
 Illuminating light: Illuminates all the digital displays in the dark by depressing the light button.
 Battery life indicator: All the digits in the display begin flashing.

PART NO.	PART NAME	PART NO.	PART NAME
354 941	Stem		
383 940	Setting lever		
389 940	Setting lever axle spring		
4007 850	LSI block		
4009 850	Crystal oscillator block		
4032 940	Bulb		
4050 852	Circuit bridge plate		
4219 940	Insulator for battery connection		
4242 941	Plus terminal of battery connection		
4256 940	Crystal holding spring		
4270 940	Battery connection		
4277 940	Contact point lever holder		
4282 850	Contact point lever A		
4282 851	Contact point lever B		
4313 850	Connector A (Red)		
4313 851	Connector B (White)		
4398 850	Liquid crystal panel frame		
4510 850	Liquid crystal panel		
4521 540	Reflecting mirror (Silver)		
4540 850	Liquid crystal panel holder		
022 256	LSI block screw		
022 256	Bulb holder screw		
022 256	Liquid crystal panel holder screw		
022 256	Circuit bridge plate screw		
022 256	Crystal oscillator block screw		
022 256	Contact point lever holder screw		
022 256	Setting lever axle spring screw		
023 061	Battery connection pin		
023 063	Tube for crystal oscillator block		
023 064	Tube for circuit block screw		
023 065	Tube for contact lever guard		
023 067	Pin for plus terminal of battery connection		
023 068	Tube for trimmer condenser		
023 902	Contact lever pin		
☆Maxell SR1130W	Silver oxide battery		
☆U.C.C. 389			
☆Toshiba WG-10			

Remarks:

Battery

The applied battery for this calibre might be added the substitutive in the future. In that case, please refer to separate "BATTERIES FOR SEIKO QUARTZ WATCHES".

☆ ⇨ Please see remarks.

Part numbers in light letters are not shown in photos.

TECHNICAL GUIDE

SEIKO DIGITAL QUARTZ

CAL. M354A

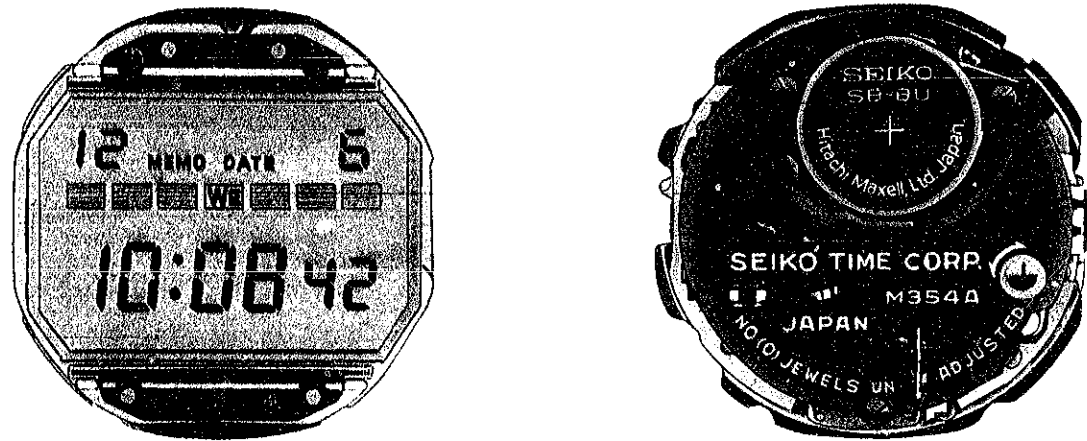

CONTENTS

I. SPECIFICATIONS	1
II. DISASSEMBLING, REASSEMBLING AND LUBRICATING	2
1. Disassembling and reassembling of the case	2
2. Disassembling and reassembling of the module and lubricating of the switch components	5
III. CHECKING AND ADJUSTMENT	8
1. Guide table for checking and adjustment	8
2. Relationship between the segment (Liquid Crystal Panel Electrode) and the C-MOS-LSI output terminal	9
3. Procedures for checking and adjustment	11

I. SPECIFICATIONS

Item	Calibre No. M354A
Display medium	Nematic Liquid Crystal, FEM (Field Effect Mode)
Liquid crystal driving system	2-layer panel multiplex driving system
Display system	Two-function changeover system <ul style="list-style-type: none"> • Time function Digital display system showing hour, minute, second, month, date and day of the week Display in 12-hour indication or 24-hour indication by depressing a button • Calendar function Digital display system showing day, date, month and year Calendar is displayed for 80 years from January, 1930 to December, 2009 by depressing a button. • Date memory function (Any designated date is set for 12 months ahead and "MEMO" mark is displayed and starts flashing on the designated day.)
Additional mechanism	<ul style="list-style-type: none"> • Battery life indicator (When the battery life comes to an end, all the digits in the display start flashing.) • Segment pattern checking system • Illuminating light
Crystal oscillator	32,768Hz (Hz = Hertz cycle per second)
Loss/gain	Loss/gain at normal temperature range Mean monthly rate : less than 10 seconds (Annual rate : less than 2 minutes) Temperature compensation device
Casing diameter	φ27.0mm
Height	6.4mm without battery
Operational temperature range	-10°C~+60°C (14°F~140°F)
Regulation system	Trimmer condenser
Battery power	Silver oxide battery: U.C.C. 389, Maxell SR1130W, Toshiba WG-10 Battery life is approximately 2 years. s (If the light is used five times a day for one second at a time.) Voltage: 1.55V
IC (Integrated Circuit)	C-MOS-LSI 1 piece

Digital quartz Cal. M354A is, in addition to the time and calendar display (hour, minute, second, month, date and day of the week), equipped with the function capable of displaying the calendar for 80 years from January, 1930 to December, 2009, and moreover a designated date can be memorized.

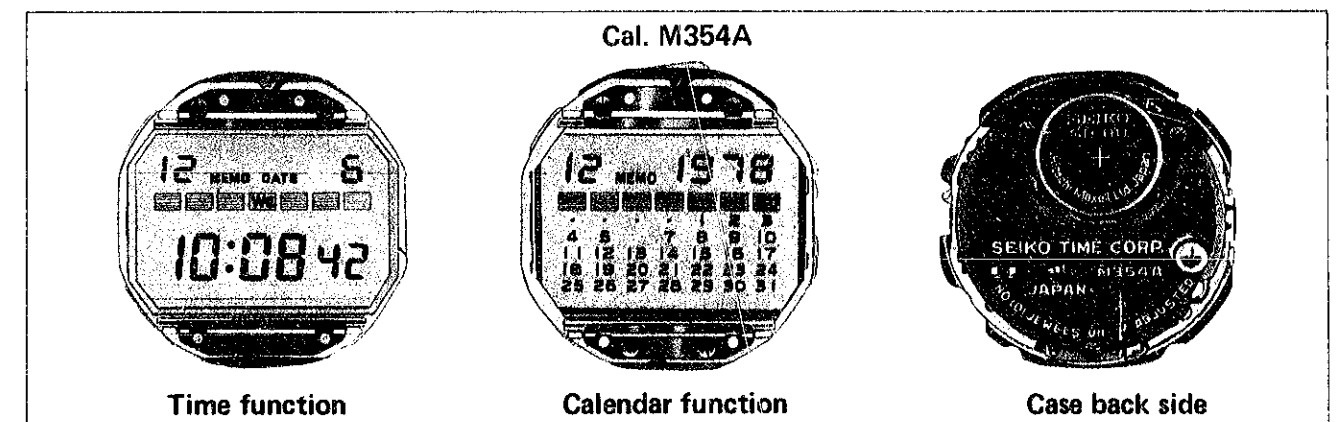

II. DISASSEMBLING, REASSEMBLING AND LUBRICATING

• Instruments for disassembling and reassembling

Movement holder	S-644	In common with Cal. M1 series, A0 series, 0139
Battery holding spring or (current supplier)	S-815 (S-833)	Used to operate the module while it is outside of the case. S-815 is in common with Cal. 0439, M1 series.

1. Disassembling and reassembling of the case

Disassembling procedures Figs: ① ~ ⑨ Lubricating  : Silicone grease 500,000 c.s., Normal quantity

Reassembling procedures Figs: ⑨ ~ ①

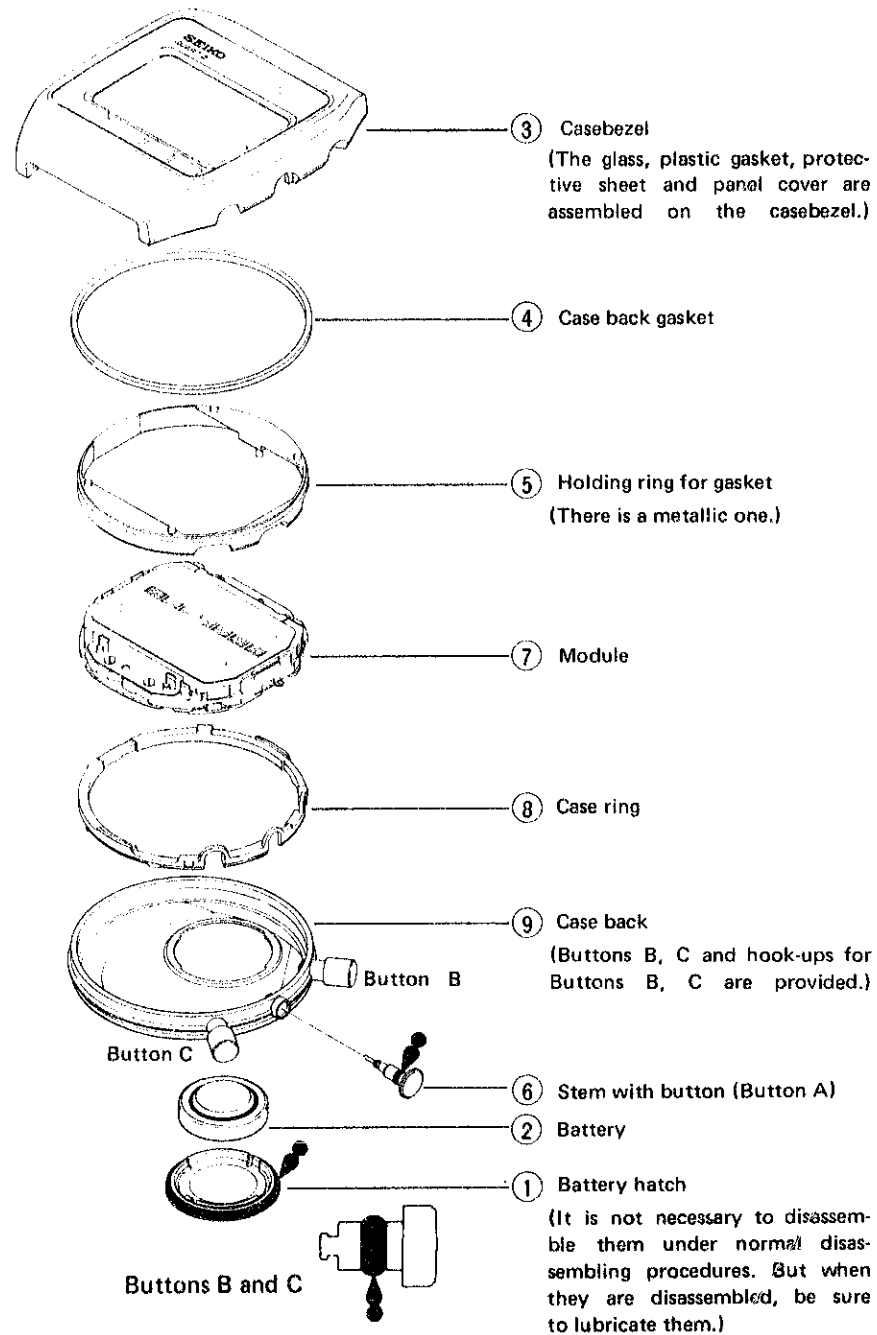

Remarks for disassembling

③ Casebezel

The casebezel can be disassembled by pushing the tip of the case opener into the opening notch.

Note: Be sure to put a vinyl sheet on the tip of the case opener before inserting it into the opening notch so as not to scratch the casebezel and the case back.

⑥ Stem with button (Button A)

While pushing the arrow-marked portion with tweezers, pull out the stem with button.

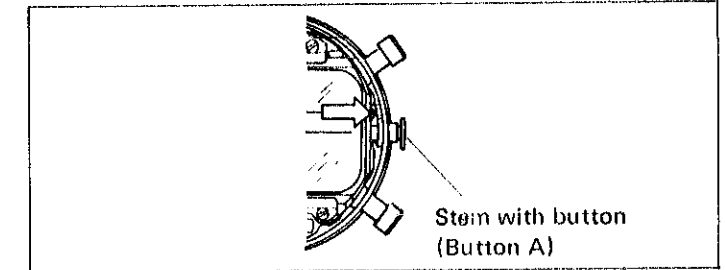
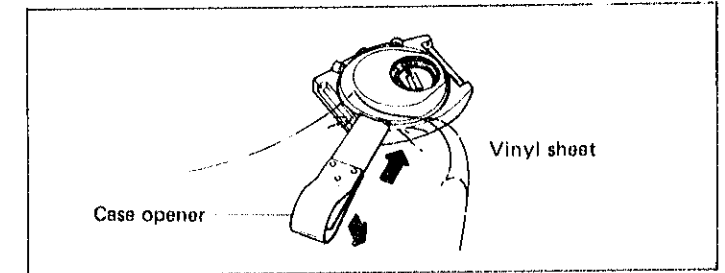

Remarks for reassembling

⑦ Module

Fit the notch of the main plate to the protrusion for correct positioning of case ring.

⑥ Stem with button (Button A)

After reassembling, check to see if the stem with button can be pulled out and depressed in correctly.

⑤ Holding ring for gasket

Fit the two protrusions for correct positioning of case ring to the holes for liquid crystal panel spring on the module.

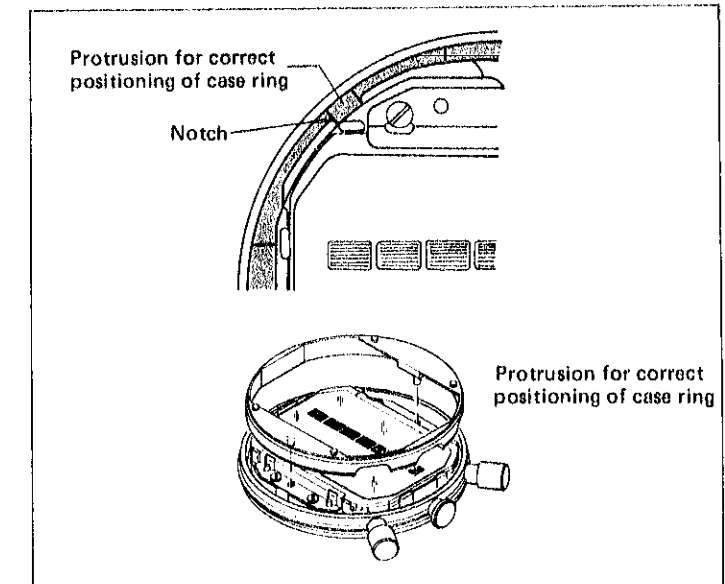

③ Casebezel

First set the casebezel to the case back. Then snap the casebezel closed to the case back by the palm with the glass surface faced down as shown in the right illustration. If the casebezel cannot be snapped closed, use the inserting disk.

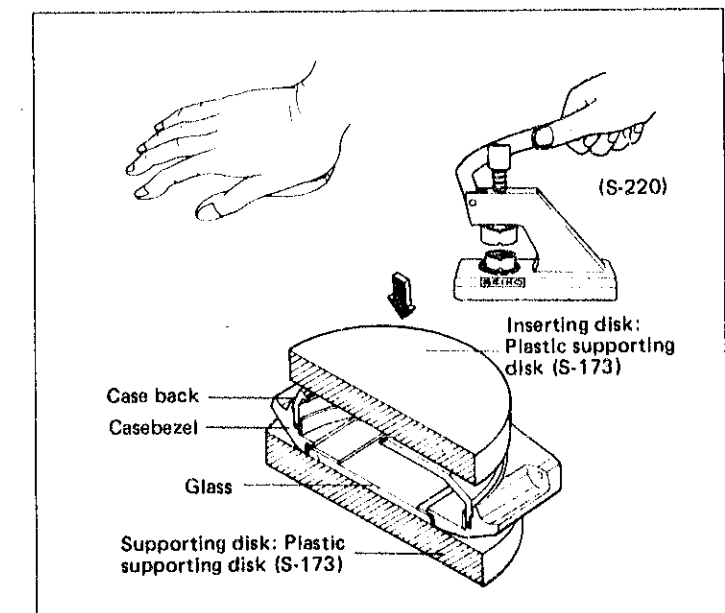

How to replace the glass

(As the glass is combined with the casebezel, disassemble it only when the replacement of parts is necessary. Use the case tightening tool S-220.)

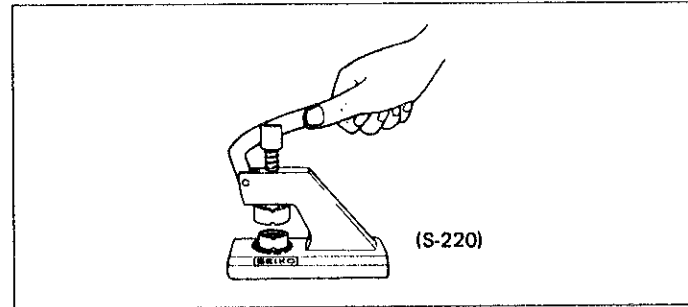

How to disassemble the glass

Use the inserting disk S-161 to disassemble the glass.

Supporting disk: $\phi 40.0\text{mm}$ (S-160)

Note: Be sure to press the glass directly so as not to touch the panel cover.

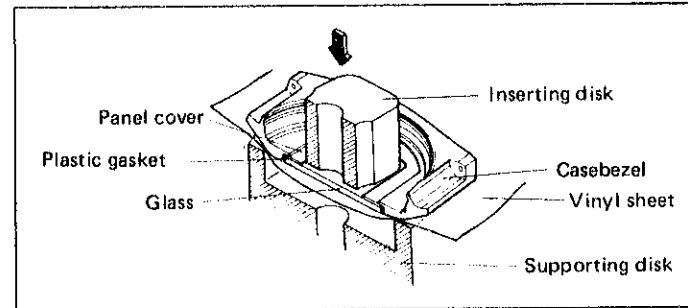

How to reassemble the glass

(i) Set the protective sheet
Be careful that the protective sheet does not bend or incline to one side.

(ii) Set the plastic gasket
• Be sure to replace it with a new plastic gasket so as to maintain high water resistance.
• Do not mistake the upper side of the gasket for the lower side.

(iii) Set the panel cover
Be sure to fit the backside of the panel cover closely to the protective sheet.

(iv) Set the glass
Do not mistake the upper side of the glass for the lower side.

(v) Push the glass in
Inserting disk : Plastic supporting disk (S-173)
Supporting disk : $\phi 26.0\text{--}\phi 26.5\text{mm}$

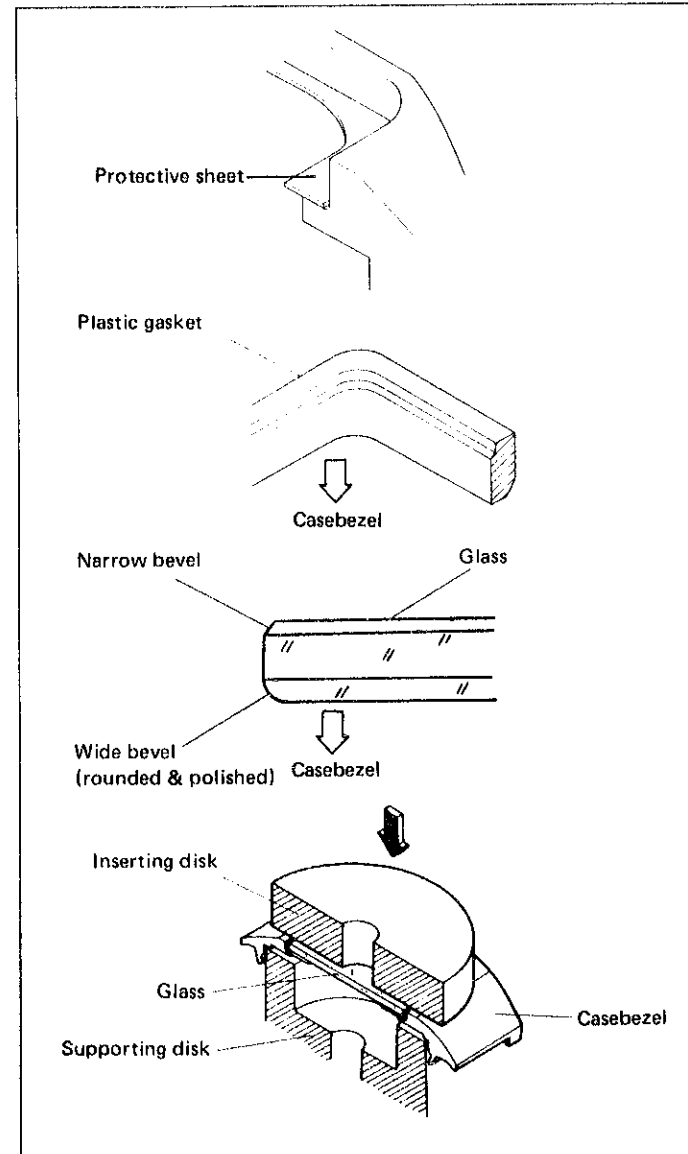

2. Disassembling and reassembling of the module and lubricating of the switch components

Disassembling procedures Figs. : ① - ②④

Reassembling procedures Figs. : ②④ - ①

Lubricating: SEIKO Watch Oil, S-6, Normal quantity

(All the screws used are the same (17 pcs.))

Note for reassembling

- After reassembling, hold the battery with the battery holding spring and check the display.
- If there is any display malfunction disassemble up to the ③ liquid crystal panel and, move the connectors slightly to the right or left before reassembling as they may be out of position.

④ Connector A (Red)

Note for disassembling
The connector A might be stuck to the liquid crystal panel.

Note for disassembling and reassembling
Be careful not to scratch with tweezers.

Note for reassembling
• Do not mistake the connector A for the connector B.

The liquid crystal panel frame is inscribed with the identification letters as shown below.

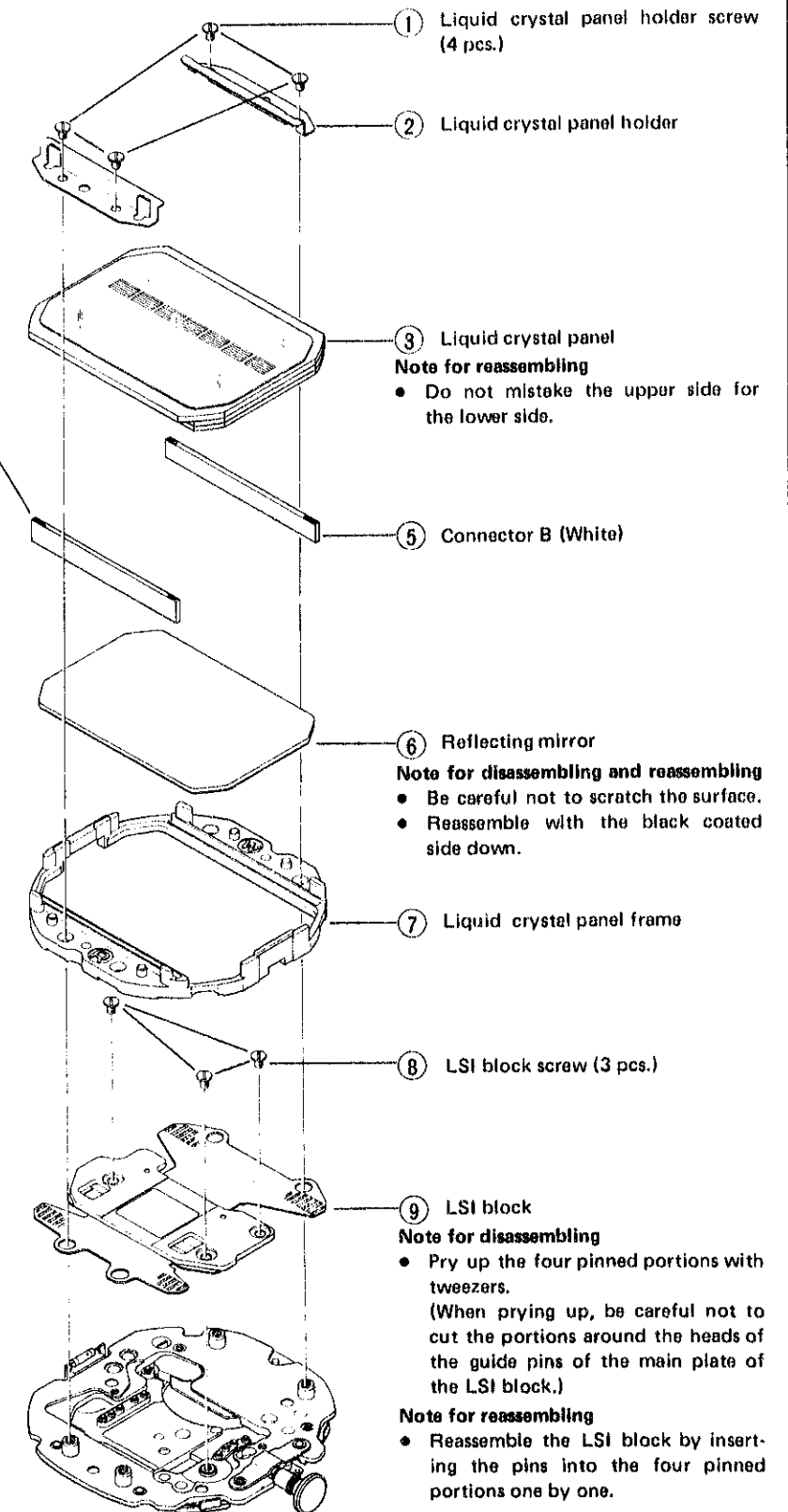
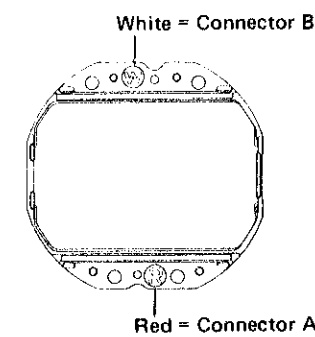

Note for reassembling

- Do not mistake the upper side for the lower side.

Note for disassembling and reassembling

- Be careful not to scratch the surface.
- Reassemble with the black coated side down.

Note for disassembling

- Pry up the four pinned portions with tweezers. (When prying up, be careful not to cut the portions around the heads of the guide pins of the main plate of the LSI block.)

Note for reassembling

- Reassemble the LSI block by inserting the pins into the four pinned portions one by one.

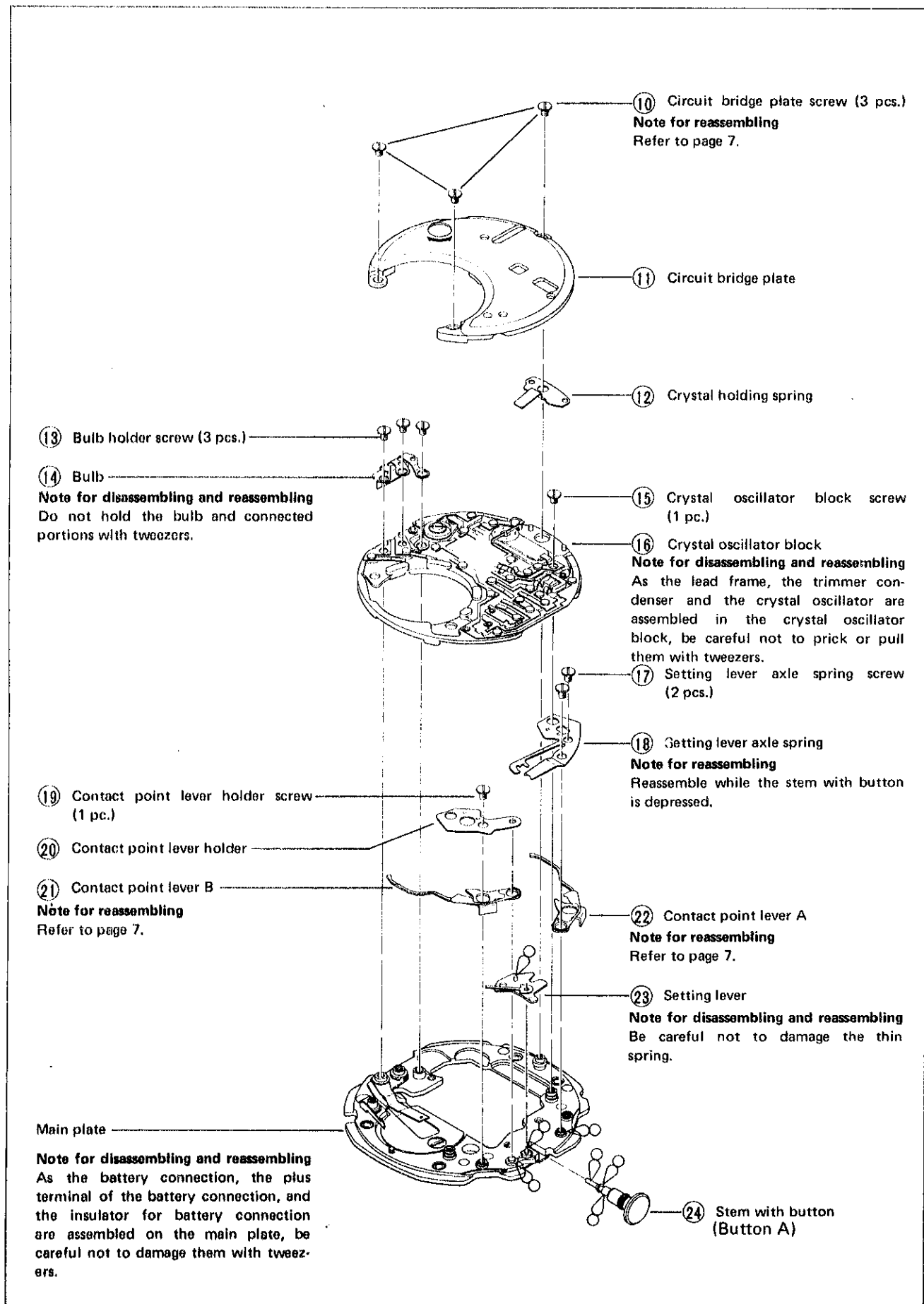

Remarks for reassembling

- ㉑ Contact point lever B
- ㉒ Contact point lever A

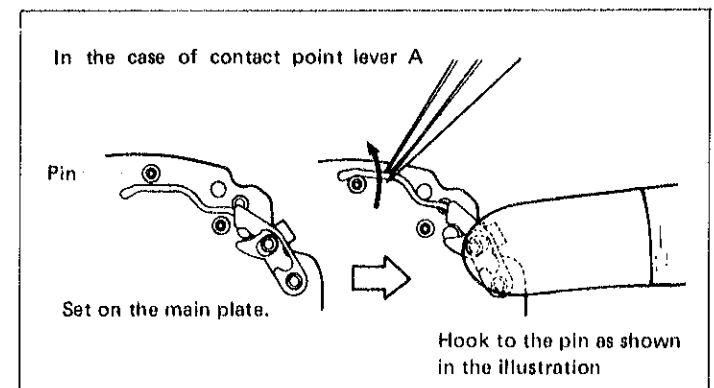

- ⑩ Circuit bridge plate screw
After reassembling up to the ⑩ circuit bridge plate screws, check by following the procedures below.

- (i) Stem with button (Button A) in the normal position
The thin spring of the setting lever does not touch either of pins a and b.

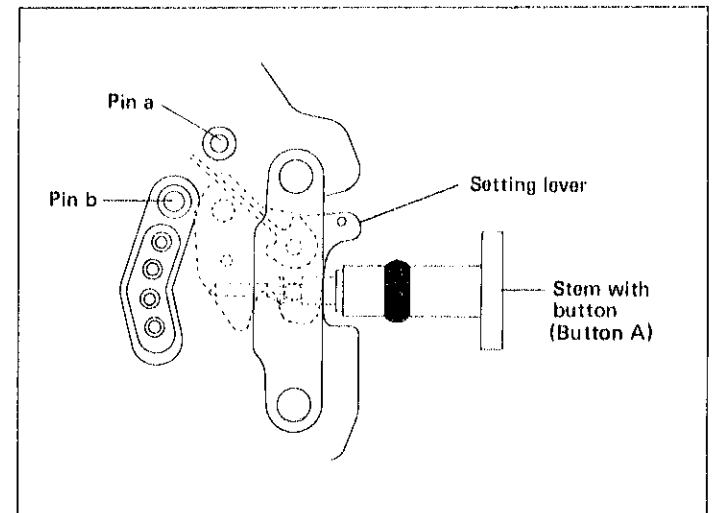

- (ii) Stem with button (Button A) in the pushed in position
The thin spring of the setting lever touches the pin a and detaches from the pin a when the hold is released.

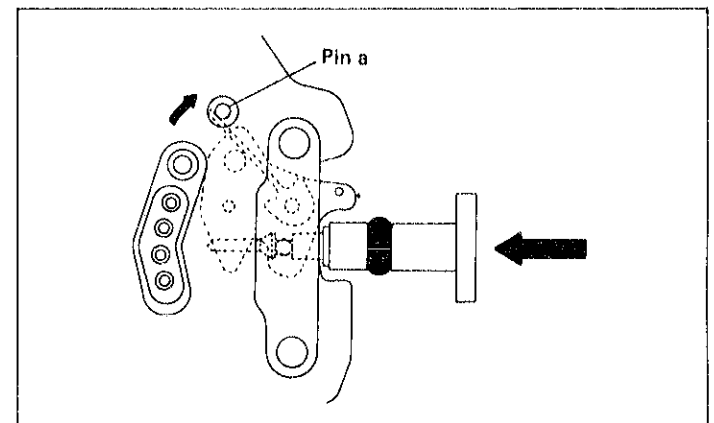

- (iii) Stem with button (Button A) in the pulled out position
The thin spring of the setting lever touches the pin b.

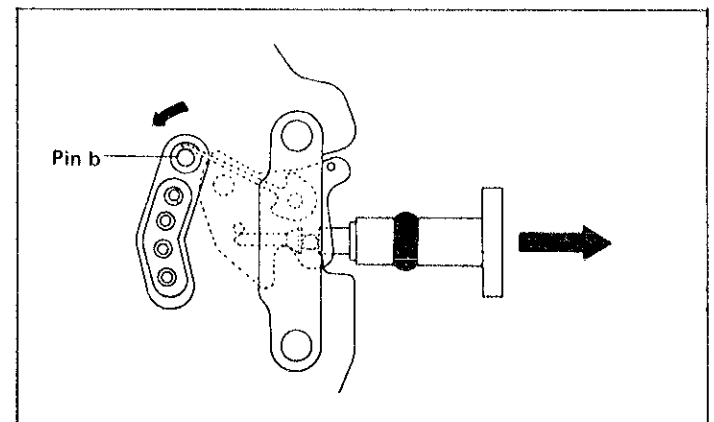

III. CHECKING AND ADJUSTMENT

Be sure to use the Static Electricity Protector (S-830) when handling the module.

1. Guide table for checking and adjustment

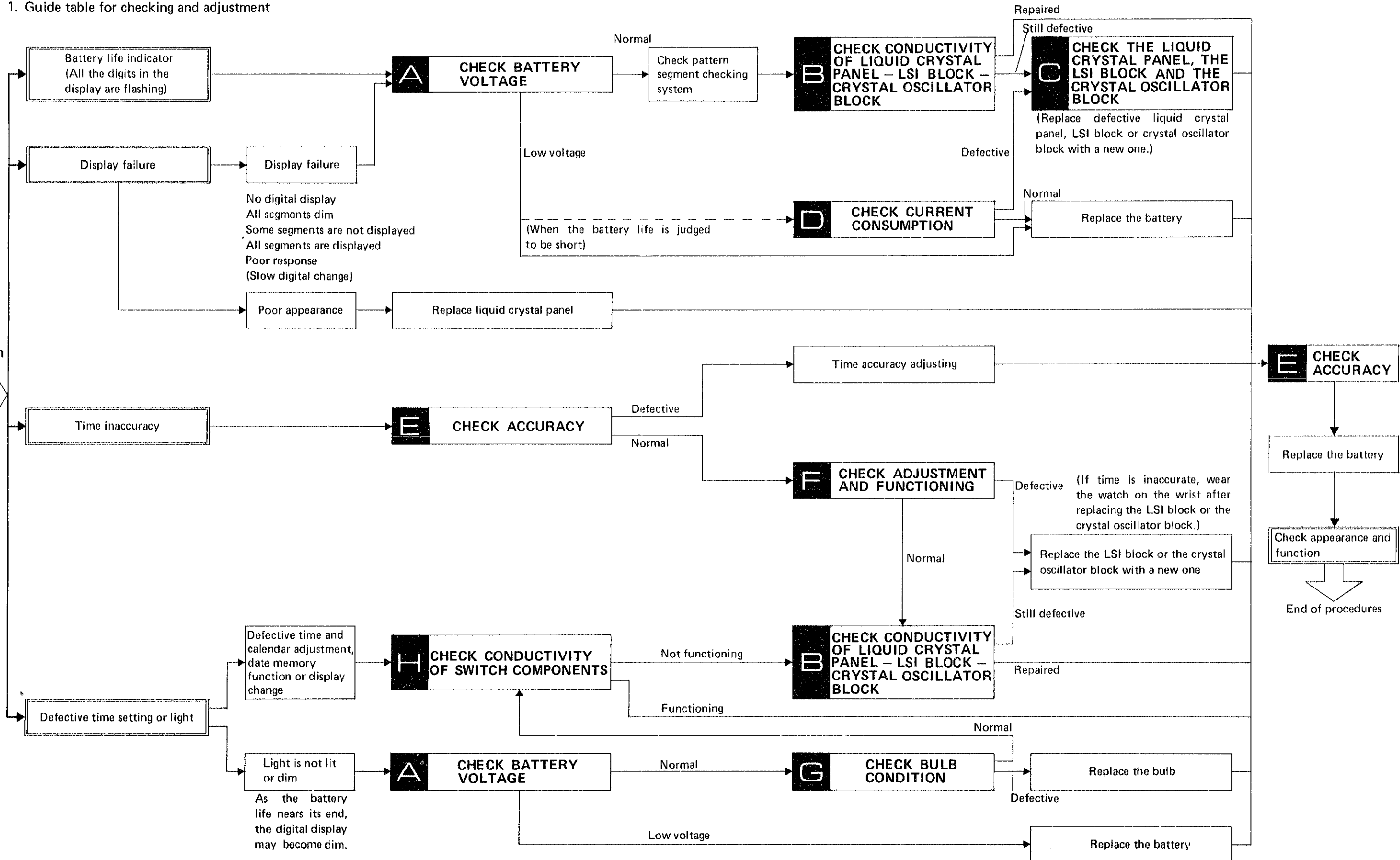



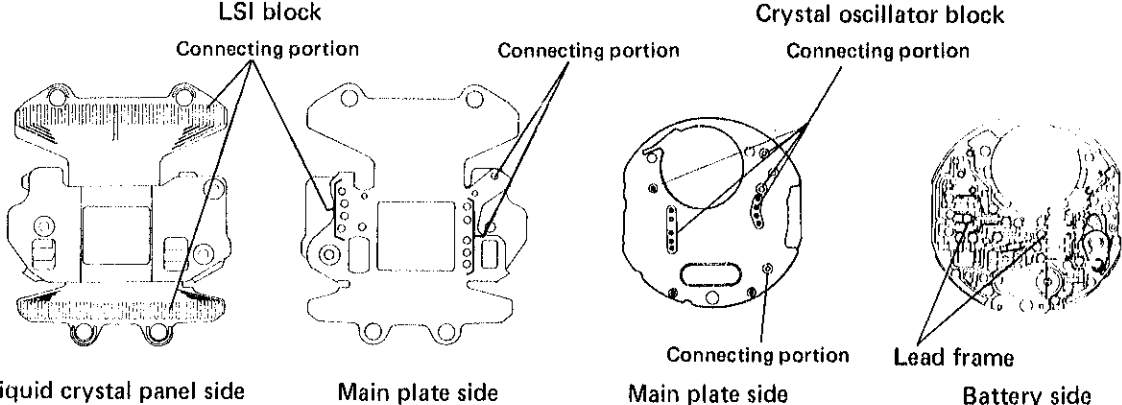

Note: Be sure to measure the time accuracy in the calendar function. (Refer to page 16 for details.)

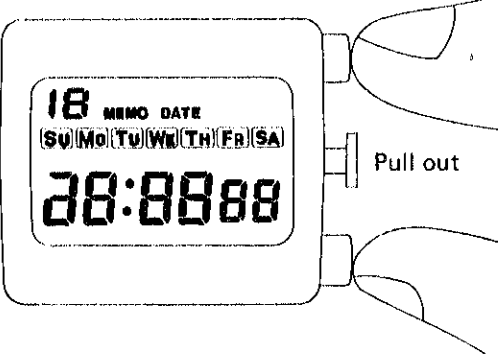
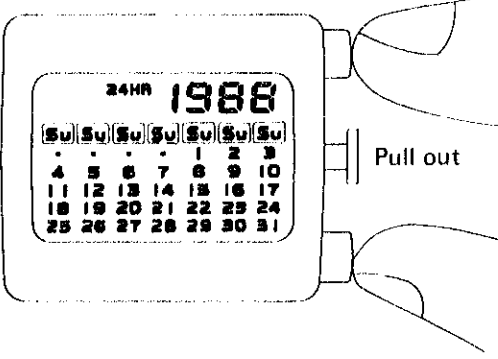
3. Procedures for checking and adjustment

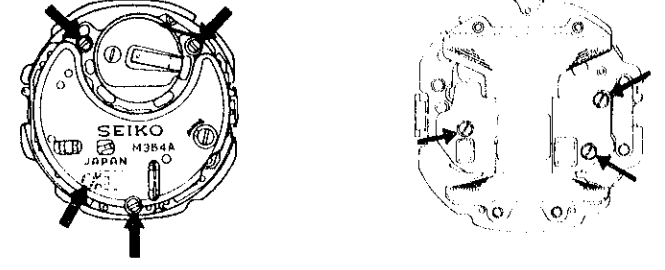
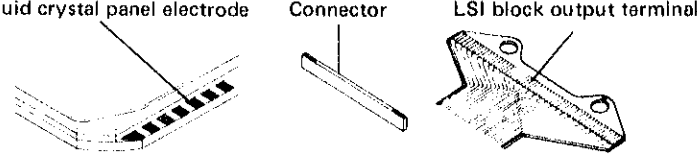
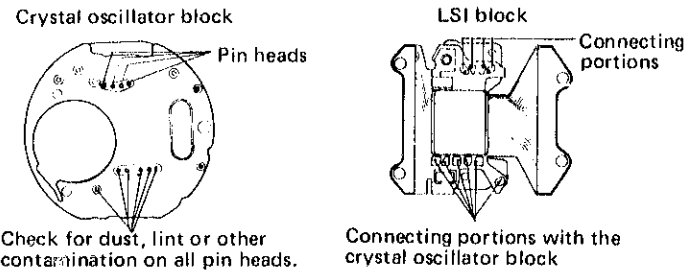
	Procedures	Result and repair
CHECK BATTERY VOLTAGE	<p>Check to see if the battery voltage is normal.</p> <div style="border: 1px solid black; padding: 5px; margin: 10px 0;"> <p>When there is battery electrolyte leakage, refer to "HOW TO CHECK BATTERY ELECTROLYTE LEAKAGE AND REPAIR" below for repairing.</p> </div>	<p>More than 1.5V → Normal</p> <p>Less than 1.5V → Defective</p>
HOW TO CHECK BATTERY ELECTROLYTE LEAKAGE AND REPAIR	<p>Procedures</p> <ol style="list-style-type: none"> (1) Remove the module from the case. (2) Disassemble the module. (3) Wipe off battery electrolyte on the crystal oscillator block and the LSI block. <ol style="list-style-type: none"> 1 Wipe off battery electrolyte carefully on the lead frame, each connecting portion, etc. with a cloth moistened with distilled water. (If distilled water is not available, use tap water.) <div style="border: 1px solid black; padding: 5px; margin: 10px 0;"> <p>Note</p> <ul style="list-style-type: none"> • Do not expose the trimmer condenser to water or alcohol, and if it is exposed, there may be a change in its condenser capacity and eventually in the time accuracy. • Do not use a cloth which gives off lint, such as gauze, flannel, etc. </div> <div style="text-align: center; margin: 10px 0;">  </div> <ol style="list-style-type: none"> 2 Wipe the crystal oscillator block and the LSI block again with a cloth moistened with alcohol. (If the cleaned portions remain wet with water, they will corrode with rust.) 3 Dry with cool air by using a dryer. (4) Wipe off battery electrolyte on the other parts (battery connection, circuit bridge plate, insulating frame for battery and others). <ol style="list-style-type: none"> 1 Wipe off battery electrolyte on each portion with a soft brush moistened with distilled water. (If distilled water is not available, use tap water.) 2 Rinse with alcohol. 3 Dry with cool air by using a dryer. 	

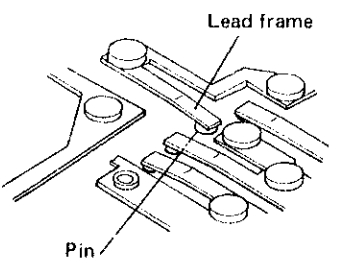
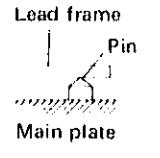
	Procedures	Result and repair
	<p>(5) Reassemble the module. Replace the battery with a new one.</p> <p>(6) Check to see if the time setting functions and the current consumption are normal. Replace the circuit block with a new one when electrolyte leaked extremely.</p> <p>(Example: When the circuit block gathers rust.)</p>	
<p style="writing-mode: vertical-rl; transform: rotate(180deg);">CHECK PATTERN SEGMENT CHECKING SYSTEM</p> <p>If some segments are dead or dim, check to see which segment is defective by following the procedures below.</p> <p>In the time function</p> <p>Depress the buttons B and C at the same time in the time and calendar adjusted conditions.</p>  <p>In the calendar function</p> <p>Depress the buttons B and C at the same time in the date memory set condition.</p>  <p>(If there is not any defective segment, all segments light up.)</p>	<p>Only one seg- → Proceed to ment does not light up Replace the liquid crystal panel.</p> <p>Two or more → Proceed to B. segments do not light up</p>	

	Procedures	Result and repair
<p style="writing-mode: vertical-rl; transform: rotate(180deg);">CHECK CONDUCTIVITY OF LIQUID CRYSTAL PANEL, LSI BLOCK AND CRYSTAL OSCILLATOR BLOCK</p>	<p>(1) Check to see if the screws are tightened firmly</p> <p>1 Crystal oscillator block screw (1 pc.), circuit bridge plate screw (3 pcs.) 2 LSI block screw (3 pcs.)</p>  <p>(2) Check for dust, lint or other contamination on the conductive portions shown in the illustration below.</p> <p>Liquid crystal panel electrode Connector LSI block output terminal</p>  <p>Crystal oscillator block Pin heads LSI block Connecting portions</p>  <p>Check for dust, lint or other contamination on all pin heads. Connecting portions with the crystal oscillator block</p> <p>(3) Check the liquid crystal panel electrode for any glass defect and the connector for any tiny break.</p> <p>Glass defect Tiny break or crack</p>  <p>(4) Remove the circuit bridge plate and check the connection of the lead frame of the crystal oscillator block with the pins by using a microscope. (10 portions)</p> 	<p>No loosened screw → Normal Proceed to B (2).</p> <p>Loosened screw → Defective Retighten the screw.</p> <p>Uncontaminated → Normal Proceed to B (3).</p> <p>Contaminated → Defective Wipe off any foreign matter.</p> <p>No glass defects, break or crack → Normal Proceed to B (4).</p> <p>Glass defects, break or crack → Defective Replace with a new one.</p> <p>Normal</p>  <p>Lead frame Pin Main plate</p> <p>If time is inaccurate, wear the watch on the wrist for test.</p> <p>Defective</p>  <p>Bend the lead frame with tweezers so that it touches the pin.</p>

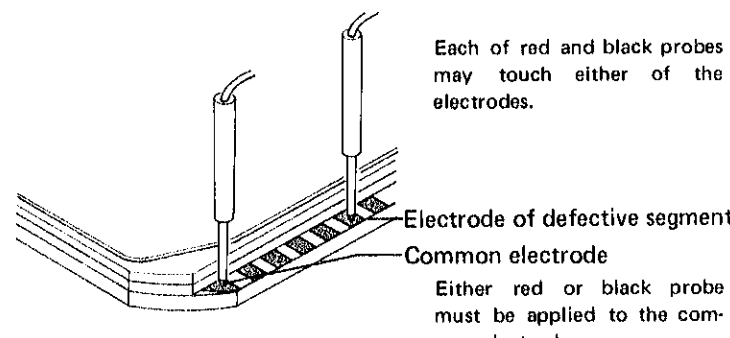
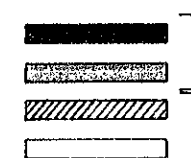
	Procedures	Result and repair
□	<p>Check to see if the liquid crystal panel, the LSI block and the crystal oscillator block function correctly.</p> <p>(1) Check the liquid crystal panel</p> <p>1 Set up the volt-ohm-meter</p> <p style="padding-left: 20px;">Range to be used: OHMS R x 1 ~ R x 1K</p> <div style="border: 1px solid black; padding: 5px; margin: 10px 0;"> <p>Note: Any range will do if more than 3V is applied to the terminal of the volt-ohm-meter. If a volt-ohm-meter other than SEIKO volt-ohm-meter S-831 is used, more than 3V may not be applied to its terminal and all the segments do not light up. Change the range to R x 10K which is higher in resistance than R x 1K.</p> </div> <p>2 Remove the liquid crystal panel from the module and turn it upside down.</p> <p>3 Measuring</p> <div style="text-align: center;">  </div> <p>The liquid crystal panel of Cal. M354A is provided with four common electrodes as shown in the illustration for "Relationship between the segment and the C-MOS-LSI output terminal" on page 10. (Two for time display and calendar display each.) Each segment lights up black by the potential between any one of these four common electrodes.</p> <p>The combination of each segment and common electrodes 1, 2, 3 and 4 is distinguished individually as shown on page 10.</p> <div style="display: flex; align-items: center; margin-top: 10px;"> <div style="margin-right: 10px;"> <p>Common electrode 1</p> <p>" 2</p> <p>" 3</p> <p>" 4</p> </div> <div style="margin-right: 10px;">  </div> <div> <p>For time display</p> <p>For calendar display</p> </div> </div>	

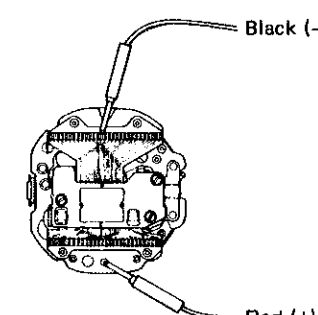
	Procedures	Result and repair
□	<p><Checking example></p> <p>When the segments of 5d, 5e do not light up:</p> <ul style="list-style-type: none"> • Check to see if 5d is combined with the common electrode 1 and 5e is combined with the common electrode 2 according to the illustration on page 10. • Make sure of the positions of the electrodes corresponding to 5d, 5e and check to see if 5d lights up black when each probe is applied to the electrodes corresponding to 5d, 5e and the common electrode 1 with the liquid crystal panel turned over. Also check to see if 5e lights up black when each probe is applied to the electrodes corresponding to 5d, 5e and the common electrode 2. <p><Note> When the segment electrode is connected with one common electrode, a segment corresponding to the other common electrode may light up at the same time. But this phenomenon does not ensure the completion of checking both the segments since it may not occur. Therefore, it is required to connect the segment electrode with the corresponding common electrode for checking.</p> <p>(2) Check the LSI block and crystal oscillator block output voltage.</p> <p>1 Set up the volt-ohm-meter</p> <p style="padding-left: 20px;">Range to be used: DC3V</p> <p>2 After reassembling the battery and the battery holding spring to the module, remove all parts from the liquid crystal panel holder screw ① to the liquid crystal panel frame ⑦ on page 5.</p> <p>3 Measuring</p> <p style="padding-left: 20px;">Probe Red (+) Main plate</p> <p style="padding-left: 20px;">Probe Black (-) One of the output terminals of the C-MOS-LSI</p> <div style="text-align: center; margin-top: 10px;">  </div> <p>(If some displays are defective, apply to the corresponding output terminal of the C-MOS-LSI)</p> <p>(3) Replace the LSI block with a new one and check the output voltage again.</p>	<p>Lights up black → Normal Proceed to □ (2).</p> <p>Does not light up → Defective Proceed to □ Replace the liquid crystal panel.</p> <p>More than 0.8V → Normal (All the terminals must show more than 0.8V.) Return to □.</p> <p>Less than 0.8V → Defective (Either of the LSI block, crystal oscillator block is defective.) Proceed to □ (3).</p> <p>More than 0.8V → Normal Proceed to □.</p> <p>Less than 0.8V → Defective Proceed to □ Replace the crystal oscillator block.</p>

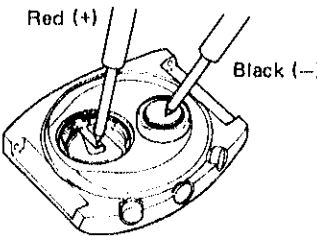
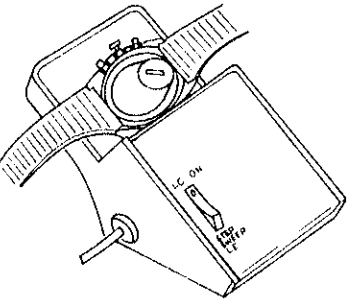
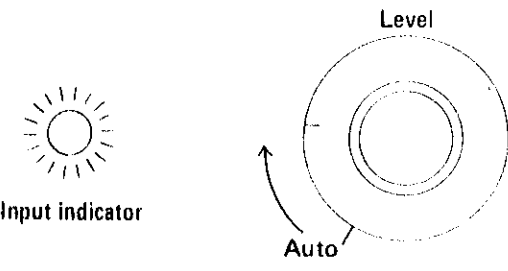
	Procedures	Result and repair
D CHECK CURRENT CONSUMPTION	<p>Check to see if the current consumption is normal. Check the current consumption in each of the time function, calendar function, time and calendar setting function and date memory set condition.</p>  <p>The illustration shows how to apply the probes.</p> <p>If it is impossible to measure the current consumption accurately in such a manner as shown in the illustration, touch the battery surface (+) to the stem with button, not to the case for measuring.</p>	<p>Less than $3.5\mu\text{A}$ → Normal Proceed to B Replace the battery.</p> <p>More than $3.5\mu\text{A}$ → Defective Proceed to C</p>
III CHECK ACCURACY	<p>Check for the gain and loss of time.</p> <p>(The measuring procedures for Cal. M354A are a little different from those for other calibres as the multiplex driving system is used for display.) The measuring procedures are the same that are used for other calibres except two procedures mentioned below.</p> <p>(1) Be sure to set the watch on the microphone in the calendar function.</p>  <p>(2) Release the level adjustor of the Quartz Tester from AUTO position and turn it slowly. Stop at the position where the input indicator lights up stably (regulated flashing or constant lighting → differs by the types of Quartz Testers and microphones). (Be careful not to turn it extremely.)</p>  <p>Input indicator</p>	<p>Normal Follow the procedures in the "1. Guide table for checking and adjustment" on page 8.</p> <p>Defective Proceed to Time accuracy adjusting</p> <p>Time accuracy is adjusted by turning the trimmer condenser.</p>

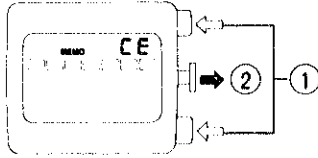
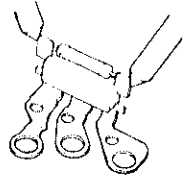
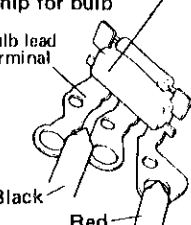
	Procedures	Result and repair
II CHECK ADJUSTMENT AND FUNCTIONING	<p>(1) Check the adjustment. Check to see if the button operation and the adjustment correspond correctly in all time adjusting functions.</p> <ul style="list-style-type: none"> Check the watch in all adjusting functions through more than one round of functioning. <p>(2) Check to see if the display changes correctly or the date memory is set by the button operation in each of the calendar function and the date memory setting.</p> <p>Note: When checking the date memory setting after battery replacement, be sure to make the ALL CLEAR operation as shown in the illustration below before checking.</p>  <p>Pull out button A while depressing buttons B and C in the calendar function.</p>	<p>Normal Proceed to B.</p> <p>Defective Replace the LSI block or the crystal oscillator block with a new one and check it again. If still defective, replace the other block with a new one.</p>
G CHECK BULB CONDITION	<p>Check to see if the bulb functions correctly.</p> <p>(1) Check to see if there are any loosened bulb holder screws (3 pcs.).</p> <p>(2) Check by using the volt-ohm-meter.</p> <ol style="list-style-type: none"> Remove the bulb from the crystal oscillator block. Set up the volt-ohm-meter: Range to be used: OHMS R x 1 Measuring <ol style="list-style-type: none"> Check to see if there is a broken filament in the bulb and if there is any break in the welded portion of the terminal. Apply the probes to both sides of the bulb. (Each of the red and black probes may touch either side of the bulb.) Check to see if the transistor for bulb functions correctly. <p>Probe Red (+) Bulb lead terminal in the right illustration</p> <p>Probe Black (-) Remaining two bulb lead terminals (touched at the same time)</p>  <p>Containing the transistor chip for bulb</p>  <p>Bulb lead terminal</p> <p>Black Red</p>	<p>No loosened screw → Normal Proceed to G (2).</p> <p>Loosened screw → Defective Retighten the screw.</p> <p>Lights up → Normal Proceed to G (2) ii.</p> <p>Does not light up → Defective Replace the bulb.</p> <p>Lights up → Normal Proceed to II.</p> <p>Does not light up → Defective Replace the bulb.</p> <p>Note: At the time of measurement the transistor for bulb may cause the bulb to become slightly dim.</p>

I

Procedures

Check to see if the switch components function correctly.
Check by using a microscope after disassembling procedures have been completed up to the LSI block ⑨ on page 5.

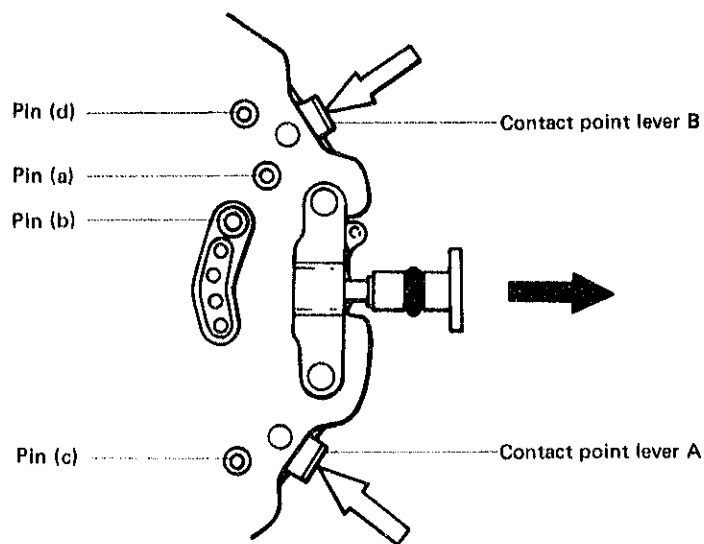

(1) Check functioning of the contact point levers A and B
Check to see if the thin springs of the contact point levers A and B touch the pins (c) and (d) when the arrow-marked portions of the contact point levers A and B are depressed by tweezers and if they detach from the pins (c) and (d) when the depressed contact point levers A and B are released.

(2) Check to see if the setting lever functions correctly.

1 Check to see if the thin spring of the setting lever touches the pin (a) when the stem with button is depressed and if it detaches from the pin (a) when the depressed stem with button is released.

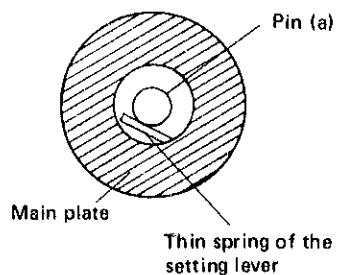

2 Check to see if the thin spring of the setting lever touches the pin (b) when the stem with button is pulled out and if it detaches from the pin (b) when the stem with button is pushed in.

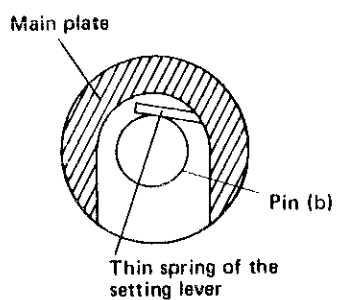

(3) Check for dust, lint or other contamination on the conductive portions of the above parts.

All Procedures of Disassembling, Reassembling, Checking and Adjustment are completed.

Result and repair

Function correctly → Normal
Proceed to **H** (2).

Do not function correctly → Defective
Adjust the contact point levers.
(If adjustment is impossible, replace the contact point levers with new ones.)

Functions correctly → Normal
Proceed to **H** (3).

Does not function correctly → Defective
Adjust the thin springs.
(If adjustment is impossible, replace the setting lever with a new one.)

Uncontaminated → Normal
Proceed to **B**

Contaminated → Defective
Wipe off any foreign matter.