

SEIKO

DIGITAL QUARTZ

Cal. F033A

PARTS LIST

Cal. F033A

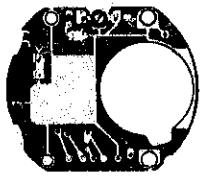
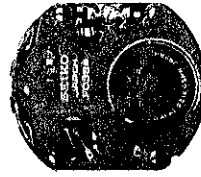
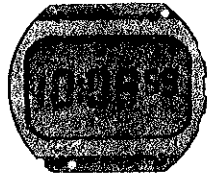

4001 102



4313 190

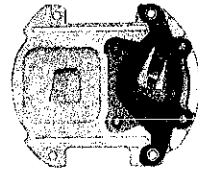

4398 037



4408 190

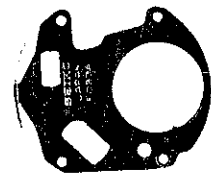

4457 195



4510 211



4540 190



☆SEIKO SB-DS

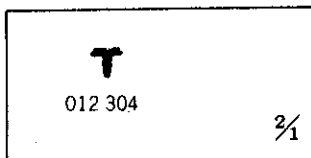

012 304

$\frac{3}{1}$

Cal. F033A

Characteristics

Casing diameter: ϕ 25.60 mm
 Maximum height: 3.30 mm without battery
 Frequency of quartz crystal oscillator: 32,768 Hz (Hz=Hertz. . . . Cycle per second)
 Time display: 12-hour Digital Display System showing hour, minute and second.
 Calendar display: The day and date are displayed by depressing the side button.
 Display medium: Single Crystal Display (Nematic Liquid Crystal, FE-Mode)
 Time micro adjustor: Trimmer condenser system
 Battery life indicator: All the digits in the display begin flashing.

PART NO.	PART NAME	PART NO.	PART NAME
4001 102	Circuit block		
4313 190	Connector		
4398 037	Battery guard		
4408 190	Insulating spacer for circuit block		
4457 195	Circuit block cover with switch spring		
4510 211	Liquid crystal panel		
4540 190	Spring for liquid crystal panel		
012 304	Screw for circuit block cover with switch spring		
☆SEIKO SB-DS	Silver peroxide battery		

Remarks:

Battery

☆SEIKO SB-DS.....The applied battery for this calibre might be added the substitutive in the future. In that case, please refer to separate "BATTERIES FOR SEIKO QUARTZ WATCHES".

TECHNICAL GUIDE

SEIKO DIGITAL QUARTZ

CAL. F033A

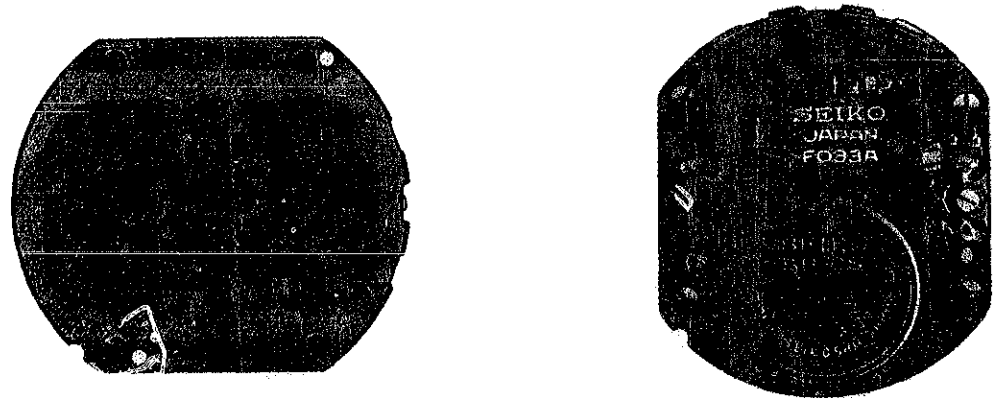

CONTENTS

I. SPECIFICATIONS	1
II. CASE	2
1. How to disassemble the case	2
2. How to disassemble the glass	2
III. DISASSEMBLING AND REASSEMBLING	4
IV. CHECKING AND ADJUSTMENTS	7
1. Guide table for checking and adjustment	7
2. Procedures for checking and adjustment	8
A: Check battery voltage	8
B: Check battery conductivity	8
C: Check conductivity of liquid crystal panel, circuit block, spacer for circuit block and connector	9
D: Check conductivity of switch components	10
E: Check circuit block and liquid crystal panel	10
F: Check current consumption	11
G: Check accuracy	11
H: Check battery life indicator	12
I: Check functioning	12

I. SPECIFICATIONS

Item	Calibre No. F033A
Display medium	Nematic Liquid Crystal, FEM (Field Effect Mode)
Display system	<ul style="list-style-type: none"> ● Time display Hour, minute and second: 12-hour digital display system ● Calendar display Date: Automatic calendar system (except February of leap years) Day: Displayed in English
Additional mechanism	Battery life indicator
Crystal oscillator	32,768 Hz (Hz=Hertz . . . Cycles per second)
Loss/gain	Loss/gain at normal temperature range Mean monthly rate : less than 10 seconds Annual rate: less than 2 minutes
Casing diameter	φ25.6 mm (21.5 mm between 12 o'clock and 6 o'clock sides)
Height	3.3 mm without battery
Operational temperature range	-10°C ~ +60°C (14°F ~ 140°F)
Regulation system	Trimmer condenser
Battery power	SEIKO SB-DS silver peroxide battery Battery life is approximately 3 years. Voltage 1.5 V
IC (Integrated Circuit)	C-MOS-LSI 1 unit

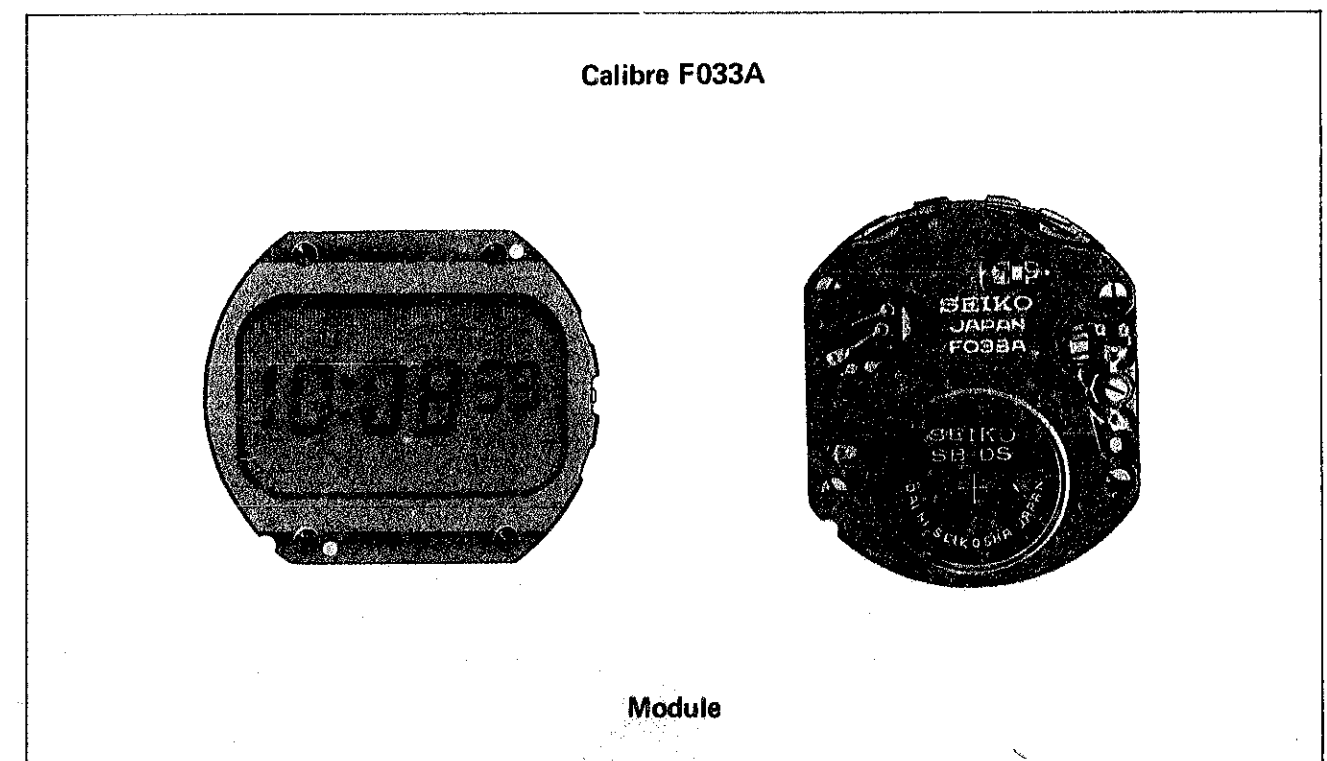

II. CASE

1. How to disassemble the case

Disassembling procedures Figs.: ① ~ ⑥

Reassembling procedures Figs.: ⑥ ~ ①

Lubricating :

Silicon grease 500,000 c.s., normal quantity

- For lubricating portions, see the illustration for "How to disassemble the buttons" on the next page.

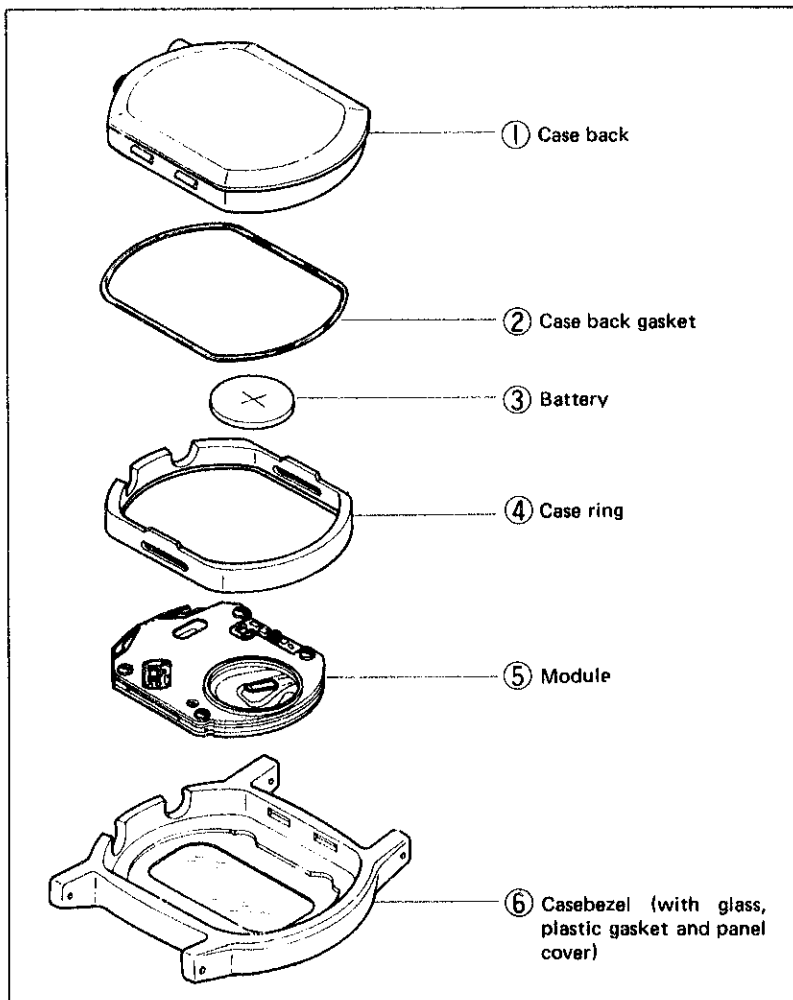

2. How to disassemble the glass

Do not disassemble the glass except when it is required to be replaced.

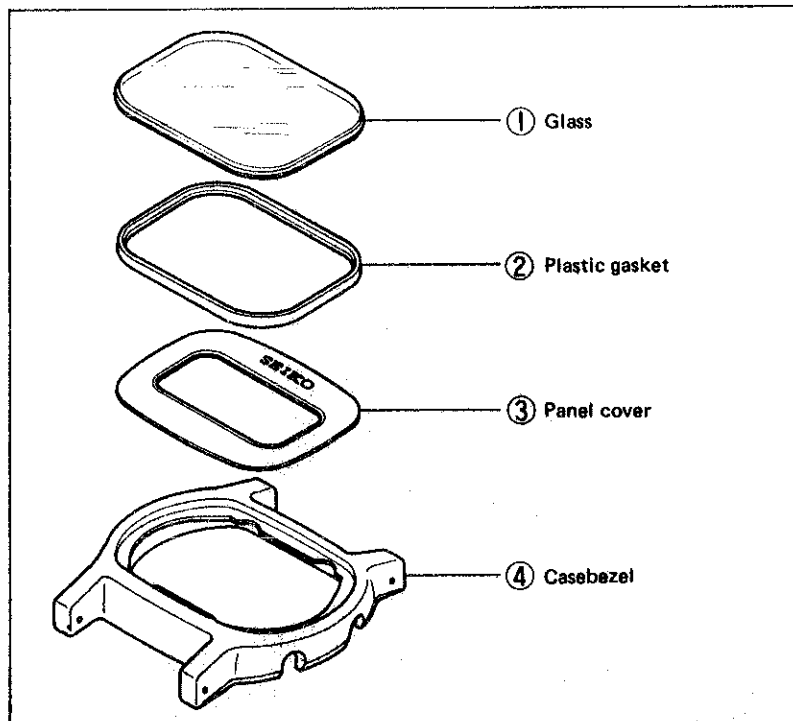

Remarks for disassembling and reassembling HOW TO REASSEMBLE THE CASE BACK

Reassemble the case back with the set and select buttons in a "PULLED OUT" position. The switch portions might be damaged if the case back is reassembled without the set and select buttons in a "PULLED OUT" position.

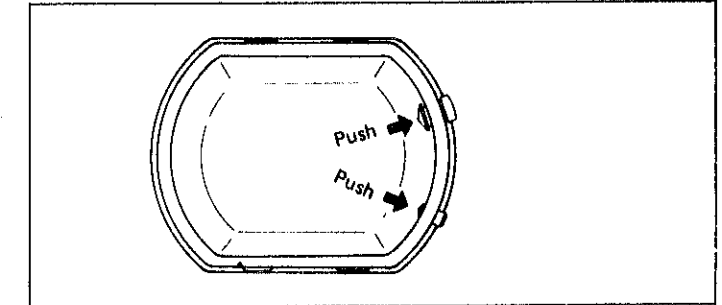

HOW TO DISASSEMBLE THE BUTTONS

• Set button (button "A")

Disassemble the hook-up for set button and then pull the set button outward for disassembling.

• Select button (button "B")

Push the select button inward for disassembling.

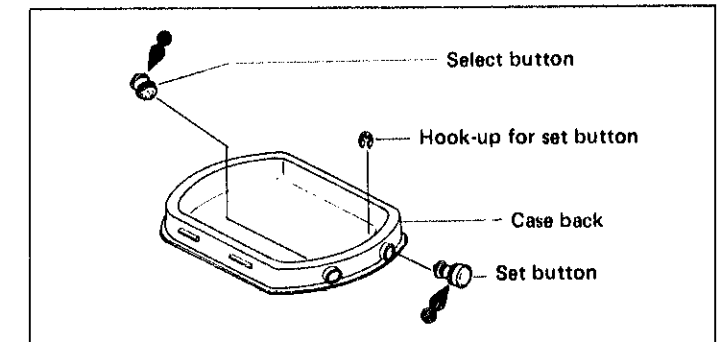

HOW TO REPLACE THE GLASS

• How to disassemble the glass (Use the tightening tool S-220)

Use the inserting disk (S-162) to push the glass from inside for disassembling. Be careful not to depress the panel cover.

Supporting disk: Select the supporting disk whose diameter is larger than that of the glass.

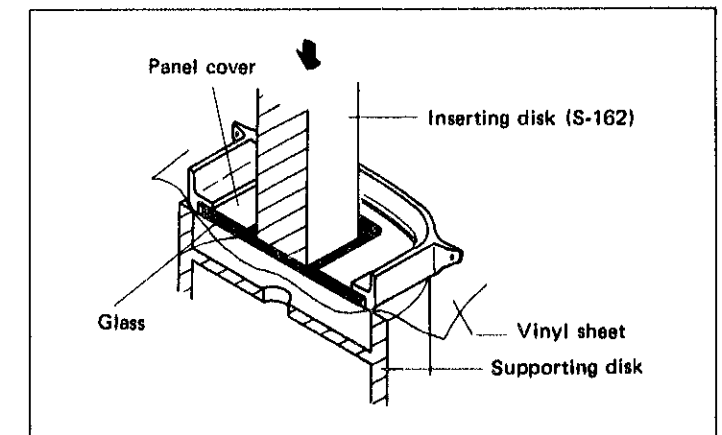

• How to reassemble the glass

Use the inserting disk (S-173).

Supporting disk: Select the supporting disk contained in S-160 Disk unit, whose diameter is smaller than the inside diameter of the casebezel.

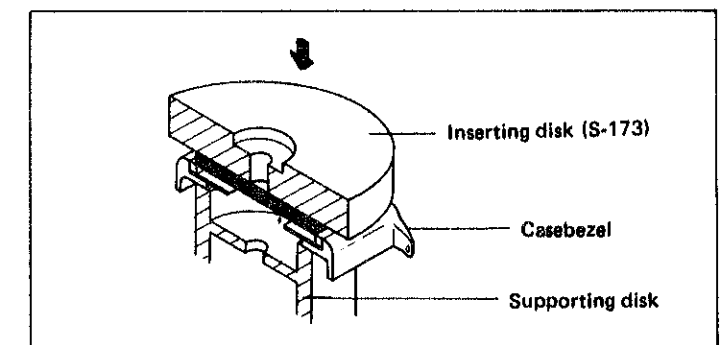

• Plastic gasket

- Be sure to replace the plastic gasket with a new one when the glass is disassembled.
- Be careful not to mistake the upper side for the lower side.

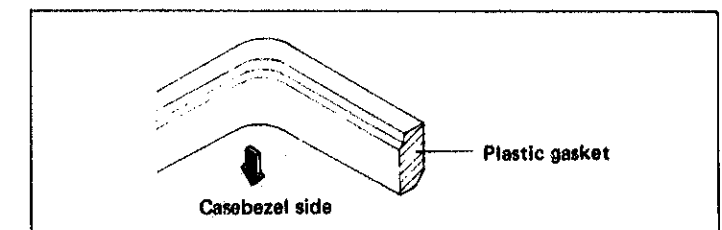

III. DISASSEMBLING AND REASSEMBLING

Disassembling procedures Figs.: ① ~ ⑧

Reassembling procedures Figs.: ⑧ ~ ①

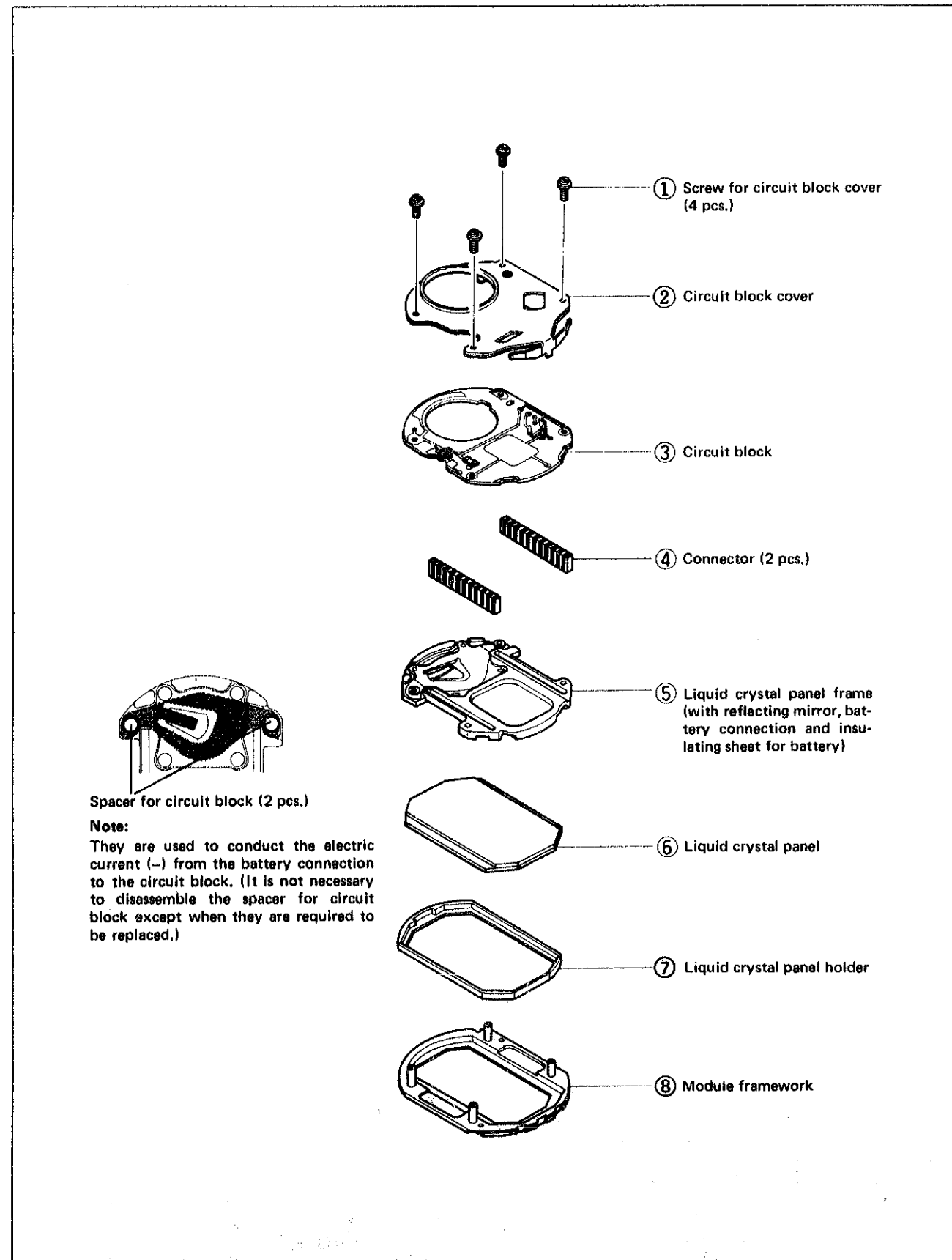

Remarks for disassembling and reassembling

① Screw for circuit block cover

Tighten the two screws on the battery side first.

④ Connector

Although two connectors are used, there is no difference between the two.

The black portions are conductive. Check to see if there are no scratches or contamination.

⑤ Liquid crystal panel frame

• How to disassemble

Push the tip of a screwdriver into the arrow-marked portions and pry up gradually for disassembling. Be careful not to scratch the reflecting mirror.

• Check to see if the spacer for circuit block is fixed to the liquid crystal panel frame.

• As the liquid crystal panel frame is combined with the reflecting mirror, battery connection and insulator for battery connection, disassemble them as one combined unit.

⑥ Liquid crystal panel

Use fingercots to disassemble and reassemble the liquid crystal panel. Be careful not to push the surface of the liquid crystal panel too hard.

• How to reassemble

Reassemble the liquid crystal panel in such a way that its part number portion comes to the top when the arrow-marked portions (button positions) of the module framework are on the right side.

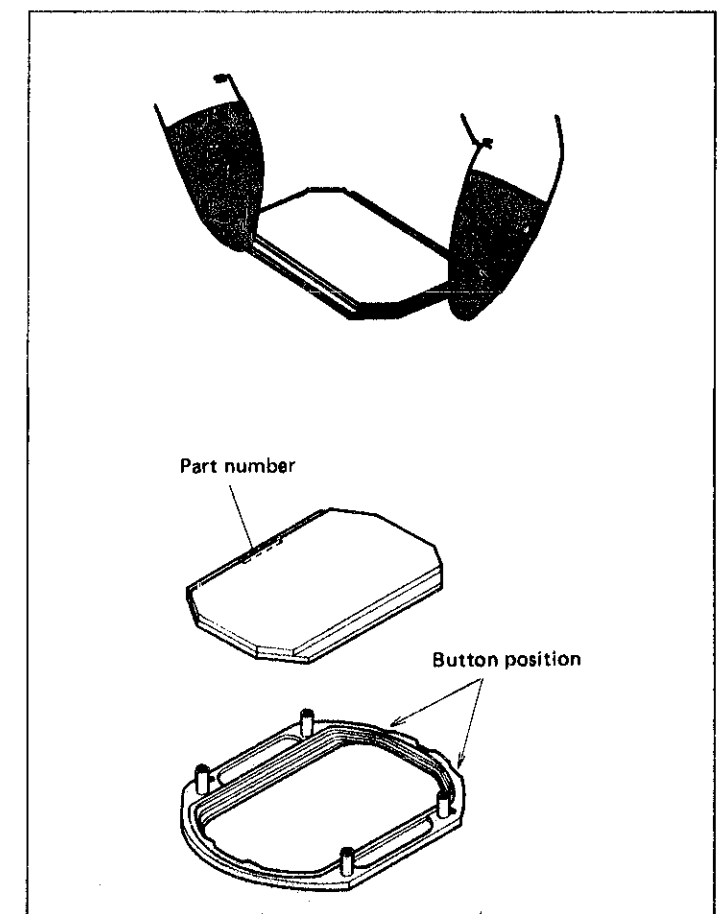
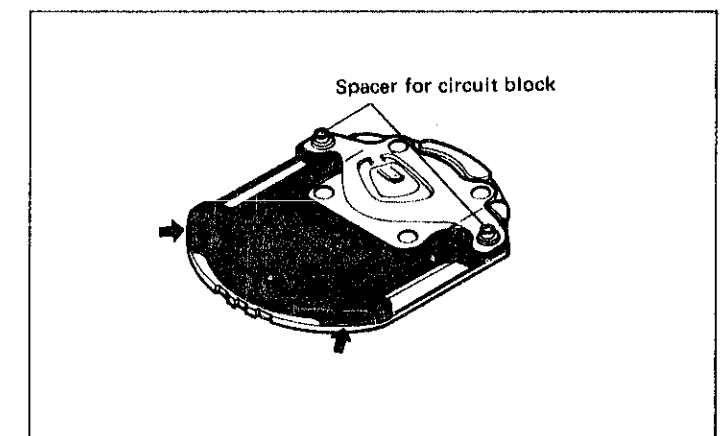

IV. CHECKING AND ADJUSTMENTS

1. Guide table for checking and adjustment

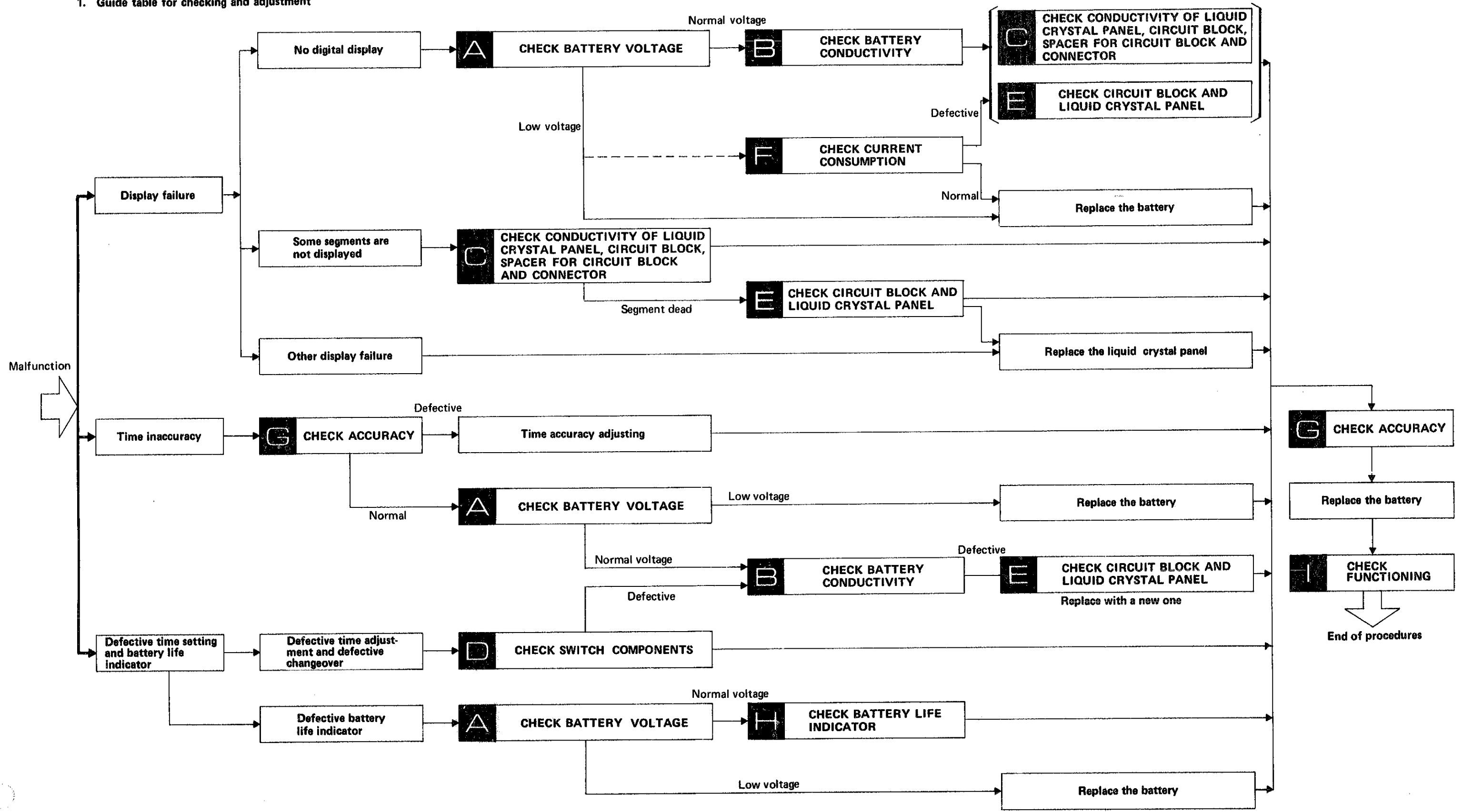

Note: If it is difficult to locate the malfunctioning portion, proceed to **I CHECK FUNCTIONING** first.

2. Procedures for checking and adjustment

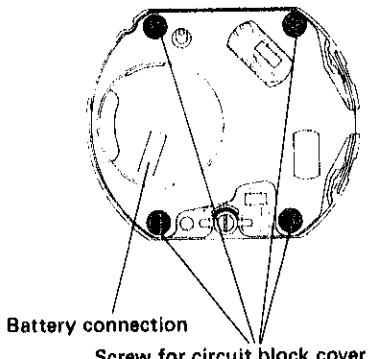
	Procedure	Result and Repair
<p>A</p> <p>CHECK BATTERY VOLTAGE</p>	<p>Measuring</p>	<p>More than 1.5V → Normal</p> <p>Less than 1.5V → Defective Replace the battery with a new one.</p>
<p>B</p> <p>CHECK BATTERY CONDUCTIVITY</p>	<p>First check Make sure that the screws for circuit block cover are tightened firmly.</p> <p>Second check Check for any contamination on the battery and the battery connection.</p>  <p>Battery connection Screw for circuit block cover</p> <p>Third check Check to see if there is battery electrolyte leakage.</p> <ul style="list-style-type: none"> How to repair battery electrolyte leakage <ol style="list-style-type: none"> Remove the module from the case and disassemble the module. Clean the parts contaminated with battery electrolyte. <ul style="list-style-type: none"> Clean the circuit block <ol style="list-style-type: none"> Wipe off battery electrolyte on the circuit block with a cloth moistened with distilled water (or normal tap water) first and then with a cloth moistened with alcohol. <p>Note:</p> <ul style="list-style-type: none"> Do not use a cloth which gives off lint such as gauze, flannel, etc. Be careful that the trimmer condenser is not exposed to water or alcohol. <p>(2) Dry with cool air by using a dryer.</p> <ul style="list-style-type: none"> Clean the other parts <ol style="list-style-type: none"> Wipe off battery electrolyte on the other parts with a soft brush moistened with distilled water (or normal tap water). 	<p>No loosened screws → Normal</p> <p>Loosened screws → Defective Retighten screws.</p> <p>Uncontaminated → Normal</p> <p>Contaminated → Defective Wipe off any foreign matter.</p> <p>No battery electrolyte leakage → Normal</p> <p>Battery electrolyte leakage → Defective Wipe off battery electrolyte by following the repairing procedure.</p>

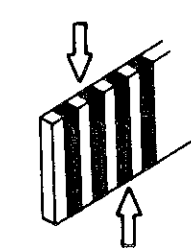
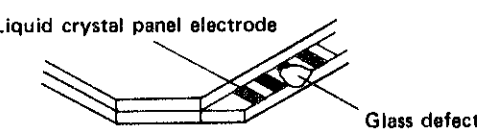
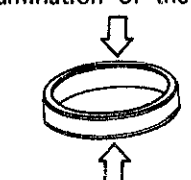
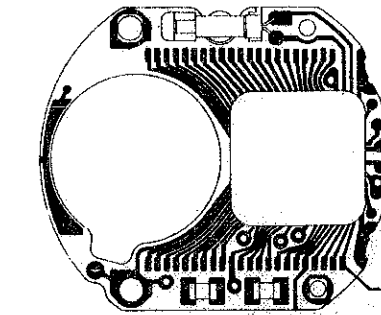
	Procedure	Result and Repair
<p>B</p> <p>CHECK BATTERY CONDUCTIVITY</p>	<p>(2) Dry with cool air by using a dryer.</p> <p>3. Reassemble the module and replace the battery with a new one.</p> <p>4. Check to see if the time setting functions and the current consumption are normal.</p>	
<p>C</p> <p>CHECK CONDUCTIVITY OF LIQUID CRYSTAL PANEL, CIRCUIT BLOCK, SPACER FOR CIRCUIT BLOCK AND CONNECTOR</p>	<p>First check Check for any contamination, crack and tiny break of the connector.</p>  <p>Second check Check the liquid crystal panel electrode for any foreign matter and glass defects.</p>  <p>Liquid crystal panel electrode Glass defect</p> <p>Third check Check for any contamination of the spacer for circuit block.</p>  <p>Fourth check Check the circuit block electrode for any foreign matter.</p>  <p>Circuit block electrode</p>	<p>No contamination, crack or tiny break → Normal</p> <p>Contaminated → Defective Wipe off any foreign matter.</p> <p>Crack or tiny break → Defective Replace the connector with a new one.</p> <p>No contamination or glass defect → Normal</p> <p>Contaminated → Defective Wipe off any foreign matter.</p> <p>Glass defect → Defective Replace the liquid crystal panel with a new one.</p> <p>Uncontaminated → Normal</p> <p>Contaminated → Defective Wipe off any foreign matter.</p> <p>Uncontaminated → Normal</p> <p>Contaminated → Defective Wipe off any foreign matter.</p>

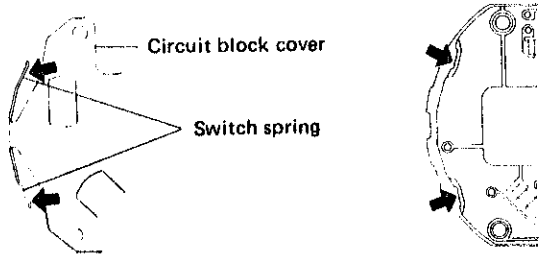
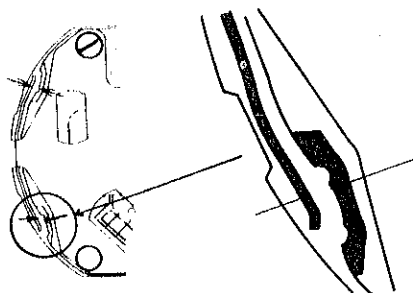
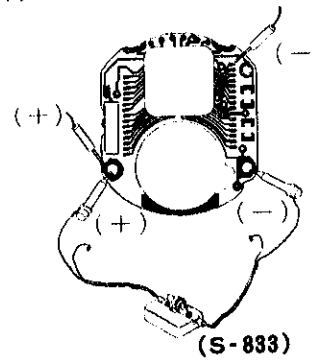
	Procedure	Result and Repair
CHECK CONDUCTIVITY OF SWITCH COMPONENTS	<p>First check Check for any contamination of the switch components (arrow-marked portions).</p>  <p>Second check Check for clearance between the circuit block cover and the circuit block. (Check after the circuit block is reassembled.)</p> 	<p>Uncontaminated → Normal</p> <p>Contaminated → Defective Wipe off any foreign matter.</p> <p>Clearance → Normal</p> <p>No clearance → Defective Correct the switch spring with tweezers so that there is a clearance.</p>
CHECK CIRCUIT BLOCK AND LIQUID CRYSTAL PANEL	<p>First check Check to see if the electric signal flows into the connector from the circuit block correctly.</p> <p>(1) Supply voltage power (1.5V) to the circuit block by using the electricity supplier (S-833).</p>  <p>(2) Set up the volt-ohm-meter. Range to be used: DC 3V</p> <p>(3) Measuring Apply the probes as shown in the above illustration. Probe Red (+) . . . Circuit block (+) Probe Black (-) . . . Circuit block electrode</p>	<p>More than 0.8V → Normal</p> <p>Less than 0.8V → Defective Replace the circuit block with a new one.</p> <p>The above voltage is obtained when measured by either the volt-ohm-meter S-831 (or AF-105) mentioned in the Technical Guide or a volt-ohm-meter whose internal resistance is higher than that of the S-831 (or AF-105).</p>

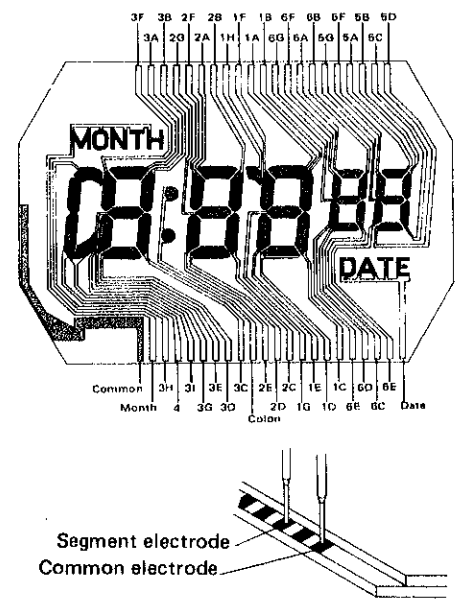
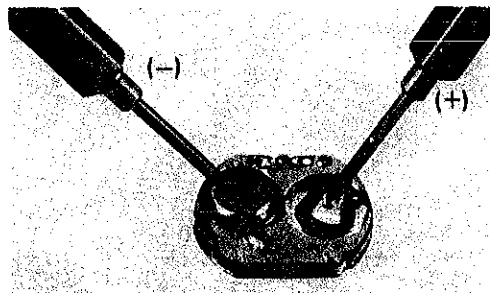
	Procedure	Result and Repair
CHECK CIRCUIT BLOCK AND LIQUID CRYSTAL PANEL	<p>Second check Check for any broken panel pattern, short circuit, etc. of the liquid crystal panel.</p> <p>(1) Set up the volt-ohm-meter. Range to be used: OHMS R X 1</p> <p>(2) Measuring Apply the red and black probes of the volt-ohm-meter to the common electrode and the segment electrode of the liquid crystal panel. (Either red or black probe will do.)</p> 	<p>Light up → Normal</p> <p>Do not light up → Defective Replace the liquid crystal panel with a new one.</p>
CHECK CURRENT CONSUMPTION	<p>Check to see if the current consumption is normal.</p> <ul style="list-style-type: none"> Measuring Probe Red (+) Battery connection Probe Black (-) Battery surface (-) 	<p>Less than 2.0μA → Normal</p> <p>More than 2.0μA → Defective Proceed to C, D and F.</p>
CHECK ACCURACY	<p>Check gain and loss of time.</p>	<p>If the watch tends to gain or lose, proceed to Time accuracy adjusting.</p>

	Procedure	Result and Repair
CHECK BATTERY LIFE INDICATOR	<p>Check to see if the battery life indicator functions correctly.</p> <p>First check</p> <p>(1) Set up the Micro Test Set the voltage at 1.1V</p> <p>(2) Apply the terminal of the Micro Test to the module. Red Clip (+) . . . Circuit block cover with switch spring Black Probe (-) . . . Battery connection</p> <p>Second check</p> <p>(1) Set up the Micro Test Set the voltage at 1.5V.</p> <p>(2) Apply the terminal of the Micro Test to the module. Red Clip (+) . . . Circuit block cover with switch spring Black Probe (-) . . . Battery connection</p>	<p>Display flashes → Normal</p> <p>Display does not flash → Defective Replace the circuit block with a new one.</p> <p>Display does not flash → Normal</p> <p>Display flashes → Defective Replace the circuit block with a new one.</p>
CHECK FUNCTIONING	<p>Check to see if display changeover and adjustment function correctly by button operation.</p>	

All procedures of Disassembling, Reassembling, Checking and Adjustment are completed.