

Cal. 6139A

### Characteristics

Casing diameter. 27.00 $\phi$ mm  
 Maximum height: 6.65 mm  
 Vibrations per hour: 21,600  
 Automatic winding with sweep second  
 Chronograph  
 Calendar (day & date)  
 Instant setting device for day & date calendar  
 Bilingual change-over system for day of week  
 "Diashock" Shock Resistant Device  
 "Diafix" Oil Lubrication Device

112523

122613

171523

401616

231618

251619

341612

345612

285614

383614

387613

015411

011206

015113

☆357612

☆998613

☆999613

193530

500521

505612

823619

838611

556611

808611

☆801618

862611

810611

868611

880611

972610

190610

571610

☆870529

573610

576610

577610

578610

585610

586610

587610

781610

783610

784610

785610

886610

889610

786610

787610

902610

022250

022269

022458

022459

022493

022494

022675

022761

3/1

Calibre No.	6139A	Jewels	21j	Style Name
⇨ Basic Calibre 6106A 25J Catalog No. 61-06-1				
PART NO.	LIST OF MATERIALS	PART NO.	LIST OF MATERIALS	
112523	Barrel & train-wheel bridge	576610	Pillar wheel	
122613	Center wheel bridge	577610	Pillar wheel ring	
161805	Pallet cock	578610	Pillar wheel jumper	
171523	Balance cock	585610	Hammer	
190610	Chronograph bridge	586610	Hammer spring	
193530	Framework for automatic device with ball-bearing	587610	Fly-back lever	
205613	Complete barrel with arbor	781610	Hammer click	
213612	Barrel arbor	783610	Minute recording jumper	
224611	Center wheel & pinion with cannon pinion	784610	First coupling lever	
225611	Cannon pinion	785610	Second coupling lever	
231618	Third wheel & pinion	786610	Chronograph finger	
251619	Escape wheel & pinion	787610	Rest of chronograph finger	
261611	Minute wheel	886610	Intermediate minute recording wheel	
271611	Hour wheel	888610	Center chronograph wheel	
281611	Setting wheel	902610	Minute recording wheel	
282611	Clutch wheel	022150	Stud screw	
285614	Ratchet wheel	022250	Screw for minute recording jumper	
301611	Jewelled pallet fork & staff	022257	Date corrector spring	
310611	Balance complete with stud	022269	Minute wheel bridge screw (Cheese-head screw)	
315611	Balance staff	022351	Center wheel bridge screw	
331610	Roller with jewel	022458	Screw for oscillating weight	
341612	Regulator	022459	Framework screw for automatic device with ball-bearing	
345612	Stud holder	022467	Ratchet wheel screw	
☆354615	Winding stem	022468	Pallet cock screw	
☆357612	Click	022471	Click screw	
381611	Setting lever with axle	022493	Bridge screw	
384611	Yoke (Clutch lever)	022493	Chronograph bridge screw	
387613	Minute wheel bridge	022494	Pillar wheel screw	
388611	Setting lever spring	022494	First coupling lever screw	
401616	Mainspring with slipping attachment	022662	Setting lever spring screw	
☆998613	Indicator wheel	022675	Holding screw for coupling levers	
☆999613	Indicator wheel spring	022677	Screw for day & date driving wheel	
014363	Diashock upper frame	022760	Minute wheel bridge screw (Chamfer-head screw)	
014364	Diashock lower frame	022760	Date dial guard screw	
014365	Diashock hole jewel with frame	022761	Dial screw	
011210	Diashock cap jewel	011167	Upper hole jewel for center wheel	
014317	Diashock spring	011146	Lower hole jewel for center wheel	
015411	Diafix lower hole jewel with frame for escape wheel	011306	Upper hole jewel for 3rd wheel	
011206	Diafix cap jewel	011306	Lower hole jewel for 3rd wheel	
015113	Diafix spring	011406	Upper hole jewel for escape wheel	
500521	Oscillating weight	011503	Upper hole jewel for pallet	
505612	Transmission wheel	011503	Lower hole jewel for pallet	
823619	Eccentric post	011147	Upper hole jewel for transmission wheel	
831611	Pawl lever with jewel	011147	Lower hole jewel for transmission wheel	
838611	Pawl lever seat	011424	Upper hole jewel for center chronograph wheel	
556611	Date finger	011544	Lower hole jewel for minute recording wheel	
☆801618	Date dial	023150	Tube for pallet cock screw (Cylinder type)	
802611	Date driving wheel	023150	Tube for balance cock screw	
808611	Date dial guard	023151	Tube for bridge screw (Cylinder type)	
810611	Date jumper	023170	Tube for pallet cock screw (Recessed type)	
817610	Intermediate date wheel	023178	Tube for bridge screw (Recessed type)	
868611	Day finger	023186	Tube for 1st coupling lever screw	
☆870529	Day star with dial disk	023189	Tube for framework screw of automatic device	
880611	Date corrector	023190	Tube for chronograph bridge screw	
883610	Date corrector spring	023417	Date corrector pin	
☆884611	Holding ring for dial	023443	Operating lever pin	
963610	Snap for day star with dial disk	023443	Fly-back lever pin	
972610	Day-date corrector finger	023444	Hammer click pin	
571610	Operating lever	023446	Intermediate minute recording wheel pin	
575610	Operating lever spring	023990	Pillar wheel jumper pin	

☆⇨Please see remarks on the next page.  
 As for all other parts not shown here, please refer to the basic calibre (Cal. No. 6106A 25J Catalog No. 61-06-1 Green page).

☆⇨Please see remarks on the next page.  
 Items in light letters are not shown in photos; those parts are interchangeable with the basic calibre (Cal. No. 6106A 25J Catalog No. 61-06-1 Green page).

Calibre No. <b>6139A</b>	Jewels <b>21j</b>	Style Name
↳ Basic Calibre 6106A 25J Catalog No. 61-06-1		

**Remarks:**

**Winding stem, Indicator wheel, Indicator wheel spring**

☆354615.....Used for other than models with rotating dial ring.

☆357612 }  
 ☆998613 } .....Used only for models with rotating dial ring.  
 ☆999613 }

If the shapes of these three parts are different from the above items, specify ① Cal. No. and ② the case No.

**Date dial**

☆801618 (White figures on black background) .....Used when both the crown and the date frame are located at **3** o'clock.

If the date dial is required in any other type, specify ① Cal. No. ② the crown position ③ the date frame position and ④ the dial No.

**Day star with dial disk**

☆870529 (English ↔ Japanese) .....Used when both the crown and the day frame are located at **3** o'clock.

When ordering any other type of the day star with dial disks, clearly mention the number printed on the disk. If the number is unknown, specify ① Cal. No. ② the crown position ③ the day frame position ④ the dial No. and ⑤ the national language.

**Holding ring for dial** ----- Measure the total thickness and the outside diameter -----

☆884611.....1.82 mm total thickness and 29.1 $\phi$ mm outside diameter.

If the holding ring for dial is required in any other type, specify ① Cal. No. and ② the dial No.

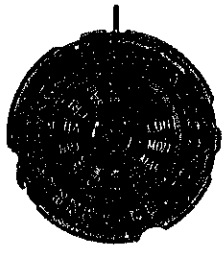
Cal. 6139A

### Characteristics

Casing diameter : 27.00φ mm  
 Maximum height : 6.65 mm  
 Vibrations per hour : 21,600  
 Automatic winding with sweep second  
 Chronograph (w/30 minutes recorder)  
 Calendar (day & date)  
 Instant setting device for day & date calendar  
 Bilingual change-over system for day of week  
 "Diashock" Shock Resistant Device

112525

122618

171522

401616

231618

251612

341612

345612

285614

383614

387613

☆ 357612

☆ 998613

☆ 999613

193532

500521

505612

823619

838611

556611

808611

☆ 801618

802611

810611

868611

880611

972610

190610

571610

☆ 870538

575610

576610

577610

578610

585610

586610

587610

781610

783610

784610

785610

886610

888610

786610

787610

902610

022250

022269

022458

022459

022493

022494

022675

022761

Calibre No.	<b>6139A</b>	Jewels	<b>17j</b>	Style Name
⇨ Basic Calibre 6106A 25J Catalog No. 61-06-1		(Automatic Chronograph)		
PART NO.	LIST OF MATERIALS	PART NO.	LIST OF MATERIALS	
112525	Barrel & train-wheel bridge	586610	Hammer spring	
122618	Center wheel bridge	587610	Fly-back lever	
161805	Pallet cock	781610	Hammer click	
171522	Balance cock	783610	Minute recording jumper	
190610	Chronograph bridge	784610	First coupling lever	
193532	Framework for automatic device with ball-bearing	785610	Second coupling lever	
205613	Complete barrel with arbor	786610	Chronograph finger	
213612	Barrel arbor	787610	Rest of chronograph finger	
224611	Center wheel & pinion with cannon pinion	886610	Intermediate minute recording wheel	
225611	Cannon pinion	888610	Center chronograph wheel	
231618	Third wheel & pinion	902610	Minute recording wheel	
251612	Escape wheel & pinion	022150	Stud screw	
261611	Minute wheel	022250	Screw for minute recording jumper	
271611	Hour wheel	022257	Date corrector spring screw	
281611	Setting wheel	022269	Minute wheel bridge screw (Cheese-head screw)	
282611	Clutch wheel	022351	Center wheel bridge screw	
285614	Ratchet wheel	022458	Screw for oscillating weight	
301611	Jewelled pallet fork & staff	022459	Framework screw for automatic device with ball-bearing	
310611	Balance complete with stud	022467	Ratchet wheel screw	
315611	Balance staff	022468	Pallet cock screw	
331610	Roller with jewel	022471	Click screw	
341612	Regulator	022493	Bridge screw	
345612	Stud holder	022493	Chronograph bridge screw	
☆354615	Winding stem	022494	Pillar wheel screw	
☆357612		022494	First coupling lever screw	
381611	Click	022662	Setting lever spring screw	
383614	Setting lever with axle	022675	Holding screw for coupling levers	
384611	Yoke (Clutch lever)	022677	Screw for day & date driving wheel	
387613	Minute wheel bridge	022760	Minute wheel bridge screw (Chamfer-head screw)	
388611	Setting lever spring	022760	Date dial guard screw	
401616	Mainspring with slipping attachment	022761	Dial screw	
☆998613	Indicator wheel	011167	Upper hole jewel for center wheel	
☆999613	Indicator wheel spring	011146	Lower hole jewel for center wheel	
014363	Diashock upper frame	011306	Lower hole jewel for 3rd wheel	
014364	Diashock lower frame	011406	Upper hole jewel for escape wheel	
014365	Diashock hole jewel with frame	011406	Lower hole jewel for escape wheel	
011210	Diashock cap jewel	011503	Upper hole jewel for pallet	
014317	Diashock spring	011503	Lower hole jewel for pallet	
500521	Oscillating weight	011147	Lower hole jewel for transmission wheel	
505612	Transmission wheel	011424	Upper hole jewel for center chronograph wheel	
823619	Eccentric post	023150	Tube for pallet cock screw (Cylinder type)	
831611	Pawl lever with jewel	023150	Tube for balance cock screw	
838611	Pawl lever seat	023151	Tube for bridge screw (Cylinder type)	
556611	Date finger	023170	Tube for pallet cock screw (Recessed type)	
☆801618	Date dial	023178	Tube for bridge screw (Recessed type)	
802611	Date driving wheel	023186	Tube for 1st coupling lever screw	
808611	Date dial guard	023189	Tube for framework screw of automatic device	
810611	Date jumper	023190	Tube for chronograph bridge screw	
817610	Intermediate date wheel	023417	Date corrector pin	
868611	Day finger	023443	Operating lever pin	
☆870538	Day star with dial disk	023443	Fly-back lever pin	
880611	Date corrector	023444	Hammer click pin	
883610	Date corrector spring	023446	Intermediate minute recording wheel pin	
☆884611	Holding ring for dial	023990	Pillar wheel jumper pin	
963610	Snap for day star with dial disk			
972610	Day-date corrector finger			
571610	Operating lever			
575610	Operating lever spring			
576610	Pillar wheel			
577610	Pillar wheel ring			
578610	Pillar wheel jumper			
585610	Hammer			

☆⇨ Please see remarks on the next page.  
 As for all other parts not shown here, please refer to the basic calibre (Cal. No. 6106A 25J Catalog No. 61-06-1 Green page).

☆⇨ Please see remarks on the next page.  
 Items in light letters are not shown in photos; those parts are interchangeable with the basic calibre (Cal. No. 6106A 25J Catalog No. 61-06-1 Green page).

Calibre No.

**6139A**

Jeweis

**17j**

Style Name

**(Automatic Chronograph)**

↳ Basic Calibre 6106A 25J Catalog No. 61-06-1

**Remarks:**

**Winding stem, Indicator wheel, Indicator wheel spring**

☆354615.....Used for other than models with rotating dial ring.

☆357612 }  
☆998613 } .....Used only for models with rotating dial ring.  
☆999613 }

If the shapes of these three parts are different from the above items, specify ① Cal. No. and ② the case No.

**Date dial**

☆801618 (White figures on black background) .....Used when both the crown and the date frame are located at **3** o'clock.

If the date dial is required in any other type, specify ① Cal. No. ② the crown position ③ the date frame position and ④ the dial No.

**Day star with dial disk**

☆870538 (English ↔ Spanish) .....Used when both the crown and the day frame are located at **3** o'clock.

When ordering any other type of the day star with dial disks, clearly mention the number printed on the disk. If the number is unknown, specify ① Cal. No. ② the crown position ③ the day frame position ④ the dial No. and ⑤ the national language.

**Holding ring for dial** ----- Measure the total thickness and the outside diameter -----

☆884611.....1.82 mm total thickness and 29.1 $\phi$ mm outside diameter.

If the holding ring for dial is required in any other type, specify ① Cal. No. and ② the dial No.

# 6139A Automatic Chronograph

## 1 Specifications

Casing diameter	27.00 mm
Height	6.65 mm
Vibrations per hour	21,600
Automatic winding	
Calendar (Day & date, bilingual change-over mechanism for day indication, instant day & date setting device)	
Chronograph (1/5 second, one revolution in 60 seconds, 30 minutes totalizer, accumulated)	

## 2 Features

An advanced automatic winding chronograph

6139A Automatic Chronograph is a high-grade functional watch in which a chronograph mechanism and an automatic winding mechanism are compactly assembled. Addition of a calendar mechanism does not affect watch size and thickness.

### Easy-to-use chronograph mechanism

The second hand and minute recorder can be activated by depressing the first button. Measured time can be accumulated just as with a regular chronograph.

Either one of two languages provided can be chosen to indicate the days of the week.

### Numerous function and design features

In addition to 30- to 70-meter depth waterproofing (70-meter depth waterproof watch employs HARDLEX special reinforced glass), a variety of functions are provided such as tachymeter, pulsimeter, and rotating dial ring.

## 3 Disassembly and assembly

Disassemble the watch according to Figs. ①→⑭

①→⑭

Assemble by reversing the above: Figs. ⑭→①

⑭→①

Installation of the automatic winding mechanism varies compared with conventional watches.

The automatic winding mechanism should be installed after setting the movement with hands in the case.

## 4 Lubrication

Colored symbols in the illustrated figures indicate the types of oil, its quantities to be applied, and lubricating points.

- Moebius Synt-A-Lube
- Seiko watch oil S-4

### Oil quantity

- Extremely small quantity
- Normal quantity
- Sufficient quantity
- ⊗ Oil must not be applied

Note: Unindicated portions do not require lubrication.

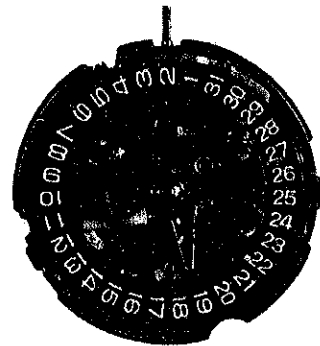

Movement

# 6139A Automatic Winding Mechanism

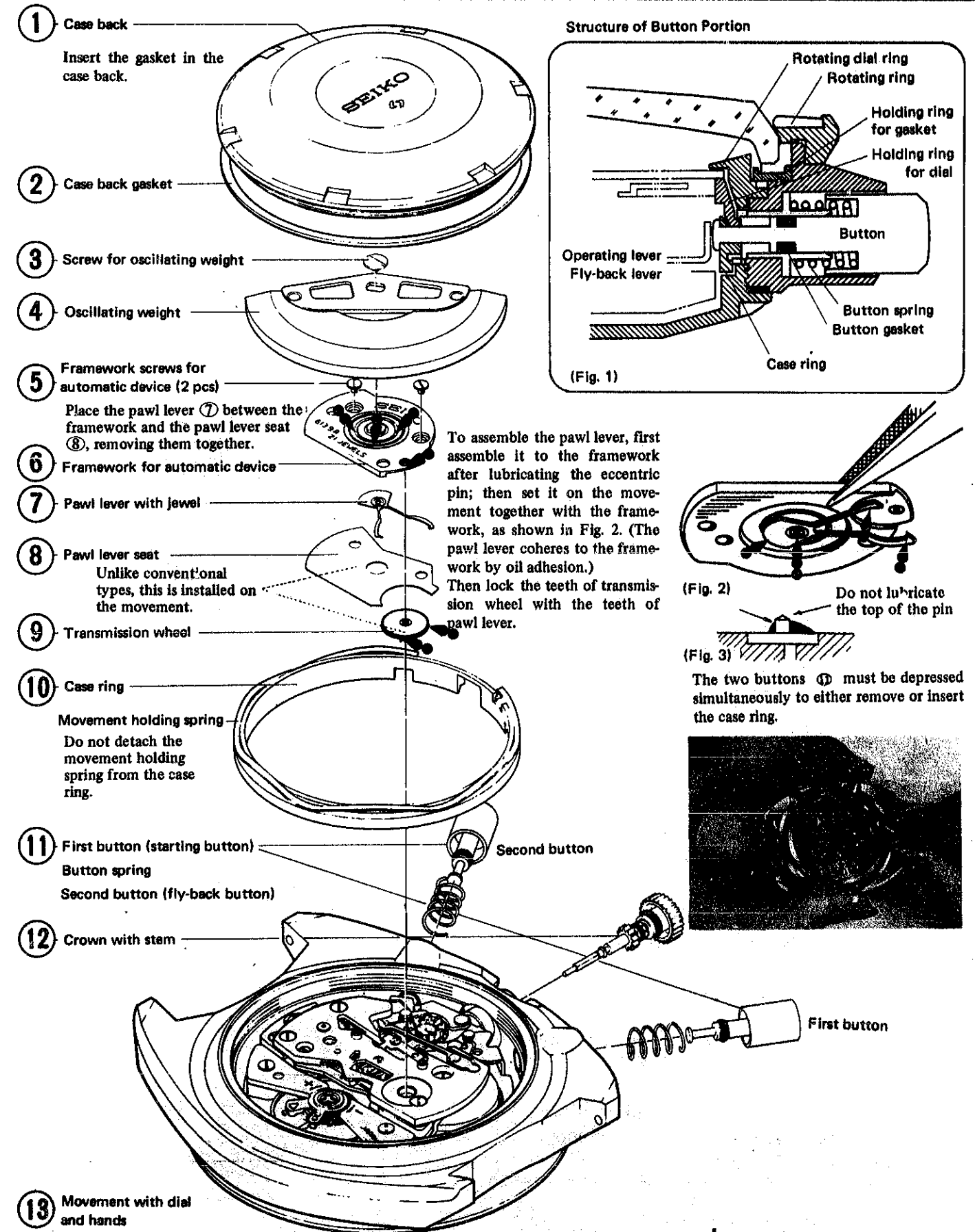

## 6139A Calendar Mechanism

**<Installing the second hand and chronograph minute hand>**

- (1) At the fly-back position, tentatively set the hands on the "0" position.
- (2) Then repeat fly-back operation to foolproof the "0" position. If the hands fail to resume correct position, adjust the hands while depressing the fly-back button.
- (3) Completely push in hands at the point where they correctly indicate the "0" position.

**NOTE:**

The second hand axle is cut as shown in the diagram. If the second hand is turned by force after completely depressing it to the bottom, the hand will loosen.

SEIKO provides a handy Movement Holder S-500 exclusively for 6139A, to facilitate hand-setting.

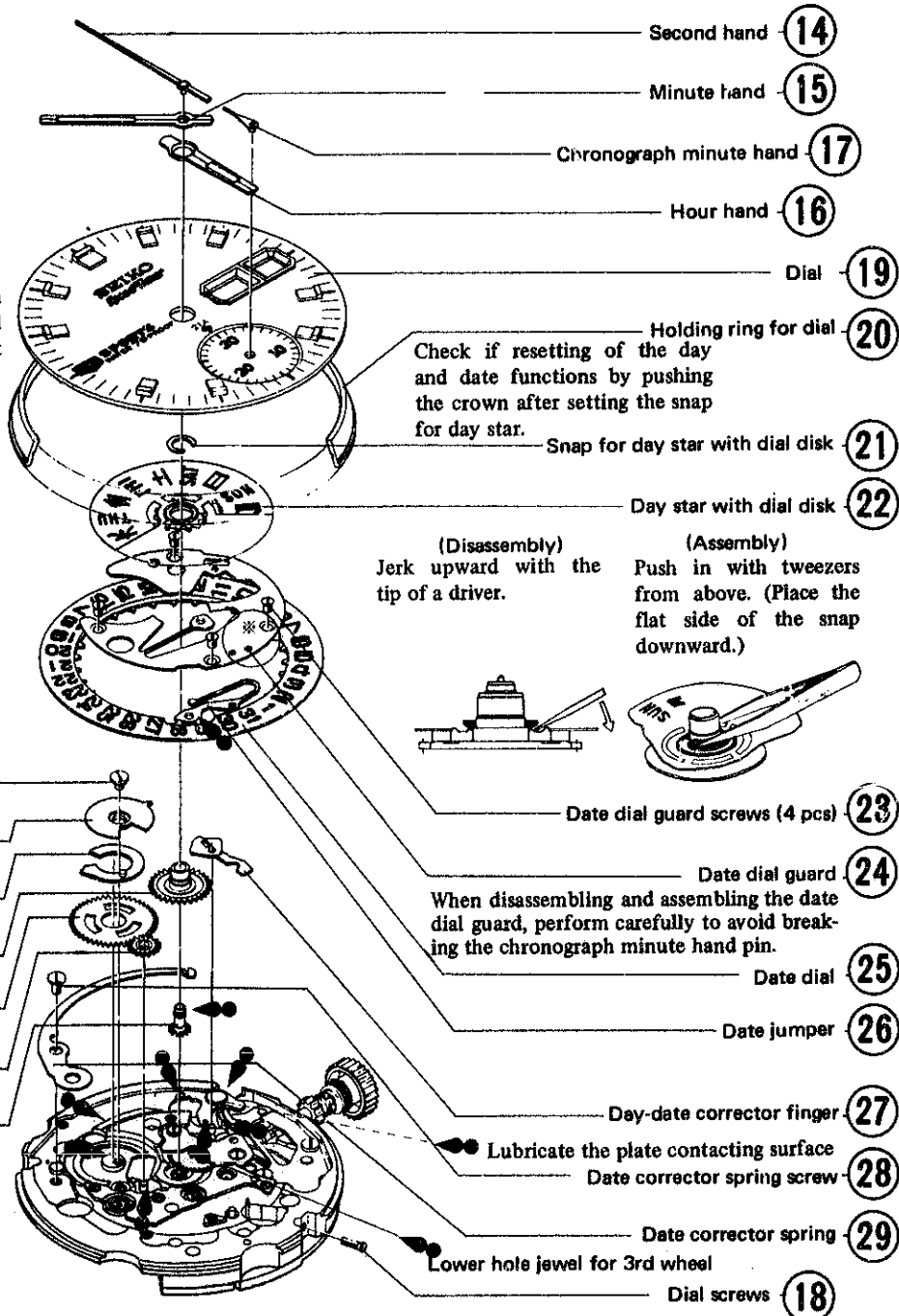
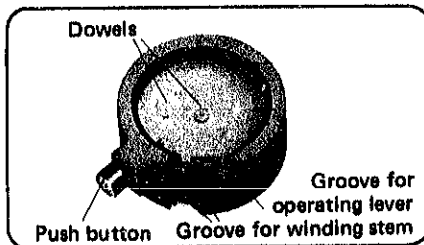

- (30) Date driving wheel screw
- (31) Day finger
- (32) Date finger (The side with two projections must face downward in assembling.)
- (33) Hour wheel
- (35) Date driving wheel
- (34) Intermediate date wheel
- (36) Cannon pinion

### Calendar Mechanism

**Day and date correction:**  
When fully depressing the crown from the ordinary position, the day and date are quickly forwarded by interlocking of stem, setting lever, date corrector, and day-date corrector finger.

**Date correction:**  
When stopping the crown at an intermediate position, only the date changes.

**Day correction:**  
Further depress the crown from the intermediate position to change only the week day indicated in English (or the other language being used). Once set, only the chosen language appears daily.

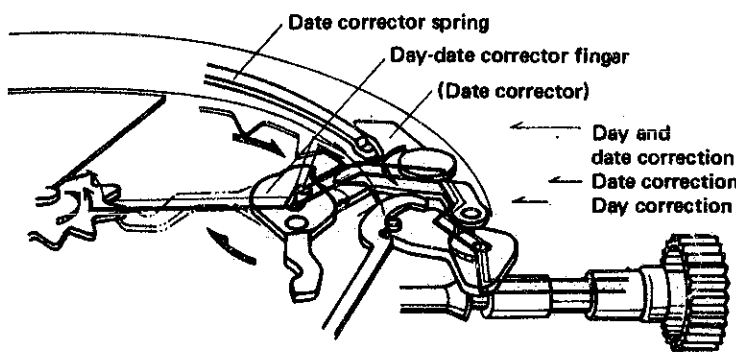

## 6139A Chronograph Mechanism,

1. Items to be checked before assembling the jewelled pallet fork and staff, after setting the chronograph bridge.

- (1) Confirm that free running force is transmitted unaffectedly. Even though no roll back motion exists, as long as it functions smoothly there is no problem.
- (2) Check for meshing condition of the first and second coupling levers (6139A-8).

2. Items to be checked after assembling the balance

- (1) Check for strength and Reight of the minute recording jumper (6139A-8).
- (2) Check for meshing position of the chronograph finger (6139A-9).
- (3) Check for contacting condition of the hammer and hearts (6139A-10).

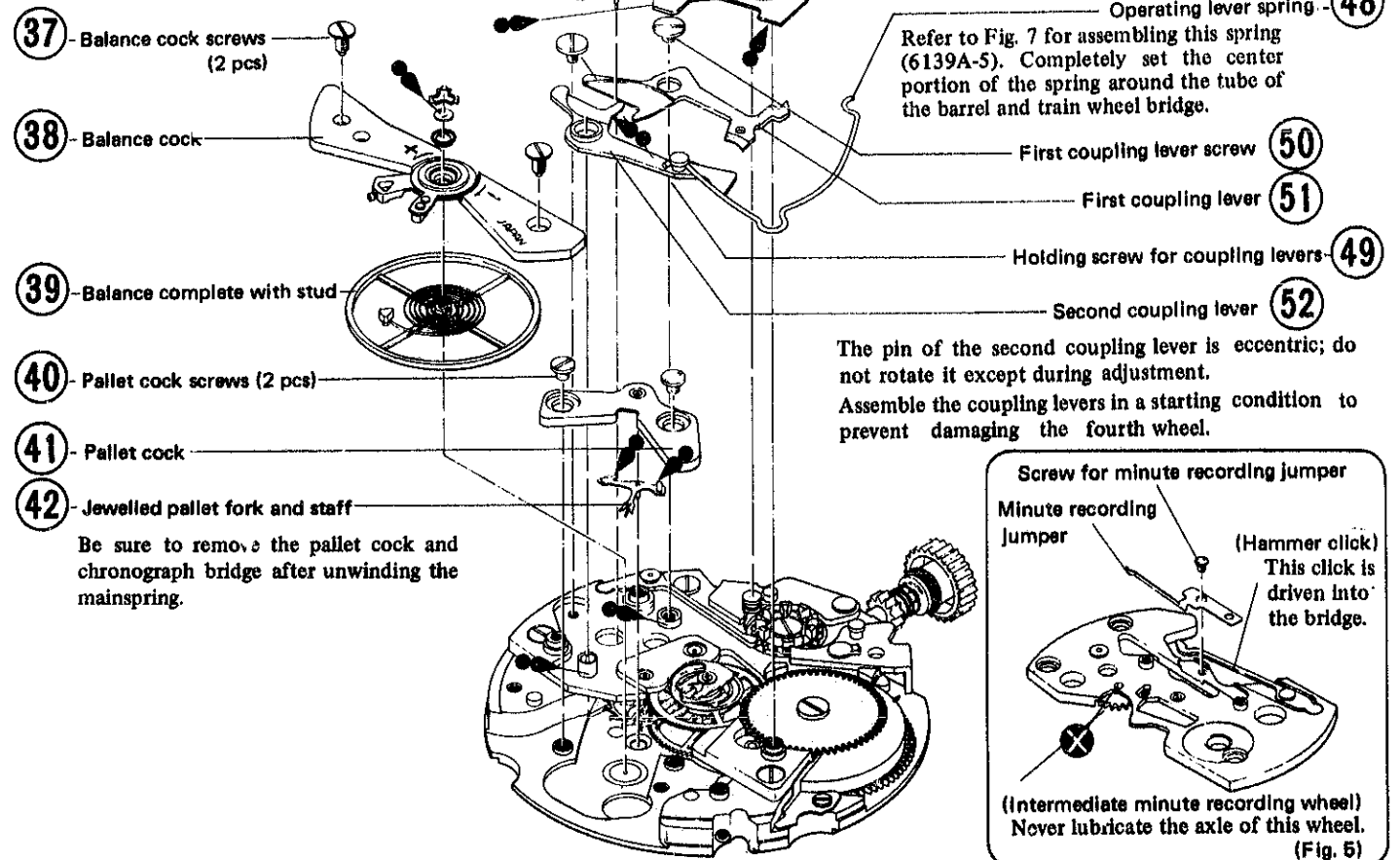

### Center Chronograph Wheel

The center chronograph wheel is composed of the fourth wheel and pinion, clutch ring, clutch spring, second heart, and center chronograph wheel axle having a chronograph finger.

While the clutch ring is pressed to the fourth wheel by a clutch spring, the fourth wheel and center chronograph wheel axle revolve as one body. When the clutch ring is separated from the fourth wheel, the center chronograph wheel axle comes to a halt, and only the fourth wheel revolves individually.

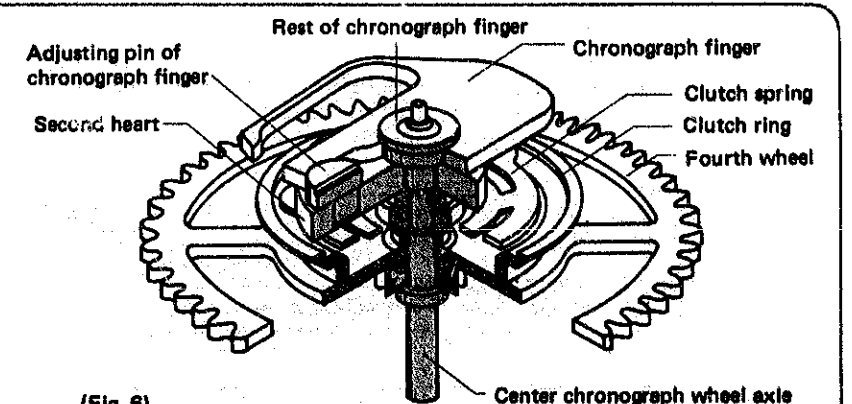

(Fig. 6)

## 6139A Operation of Chronograph Mechanism

### Starting

When depressing the first button, the pillar wheel is forwarded one tooth and the pillar wheel contacting portion of the first coupling lever falls between the columns, and the first and second coupling levers are separated from the clutch ring. The clutch ring is pressed to the fourth wheel by the clutch spring, and the second hand starts moving.

When the second hand makes a complete turn, the chronograph finger forwards the minute recording wheel one tooth through the intermediate minute recording wheel, operating the minute hand one graduation.

### Stopping

When depressing the first button in a started condition, the first and second coupling levers operate, raising the clutch ring. The clutch ring is separated from the fourth wheel, and the second hand comes to a halt. This time, the fourth wheel continues to rotate.

### Accumulation

When further depressing the first button in a stopped condition, the mechanism returns to a starting condition (Fig. 7), and the chronograph hands restart from its stopped position, the measured time being accumulated.

### Resetting

When depressing the second button in a stopped condition, the hammer is operated through the fly-back lever striking the second and minute hearts, and the hands are reset to the "0" position.

(When the hammer is on the column, i.e. the hands are in motion, the second button (fly-back button) cannot be depressed.)

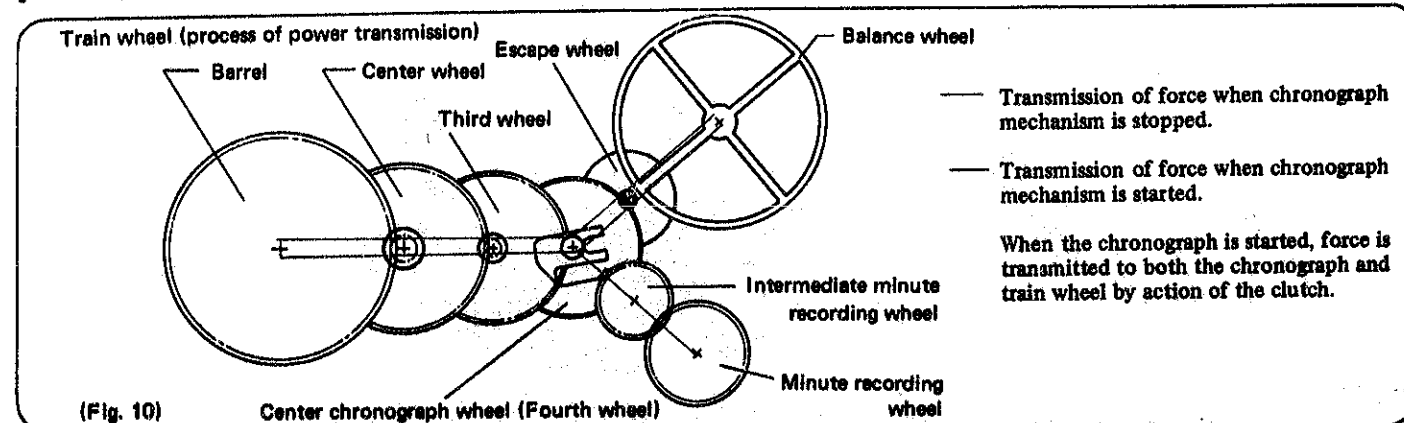
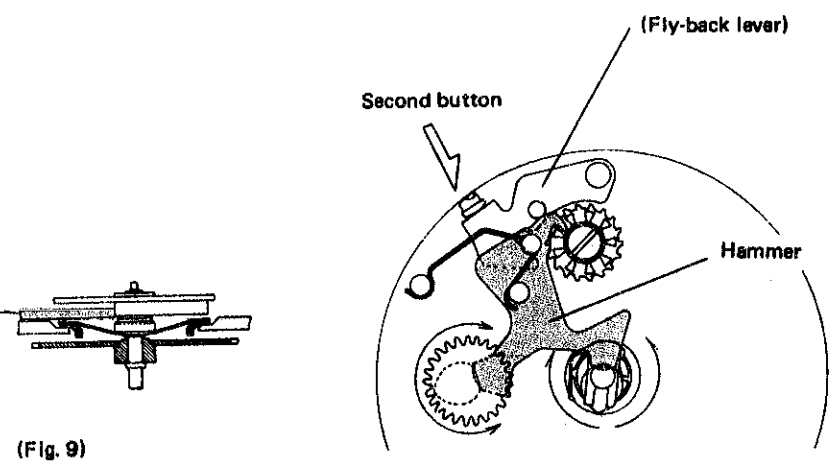
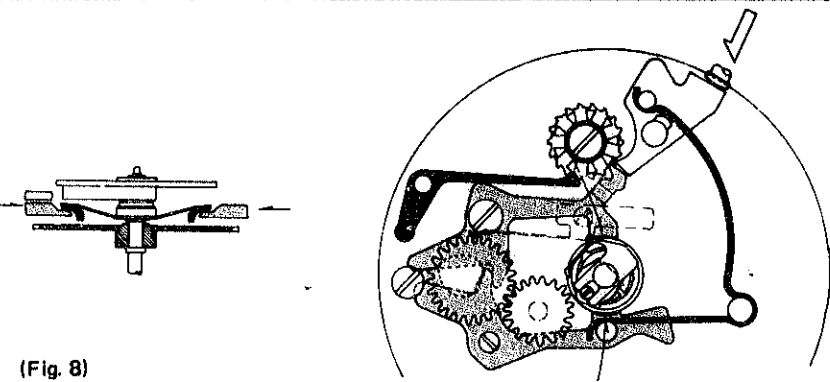
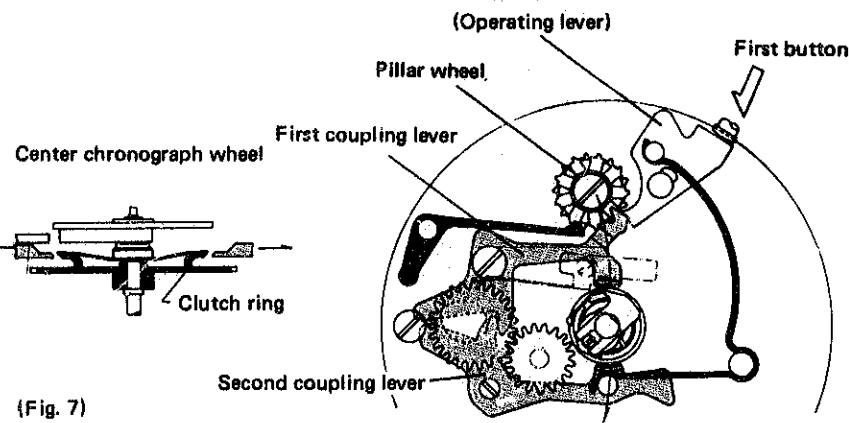

## 6139A Train Wheel

To prevent chipping, install the pillar wheel on the barrel and train wheel bridge before assembling the latter.

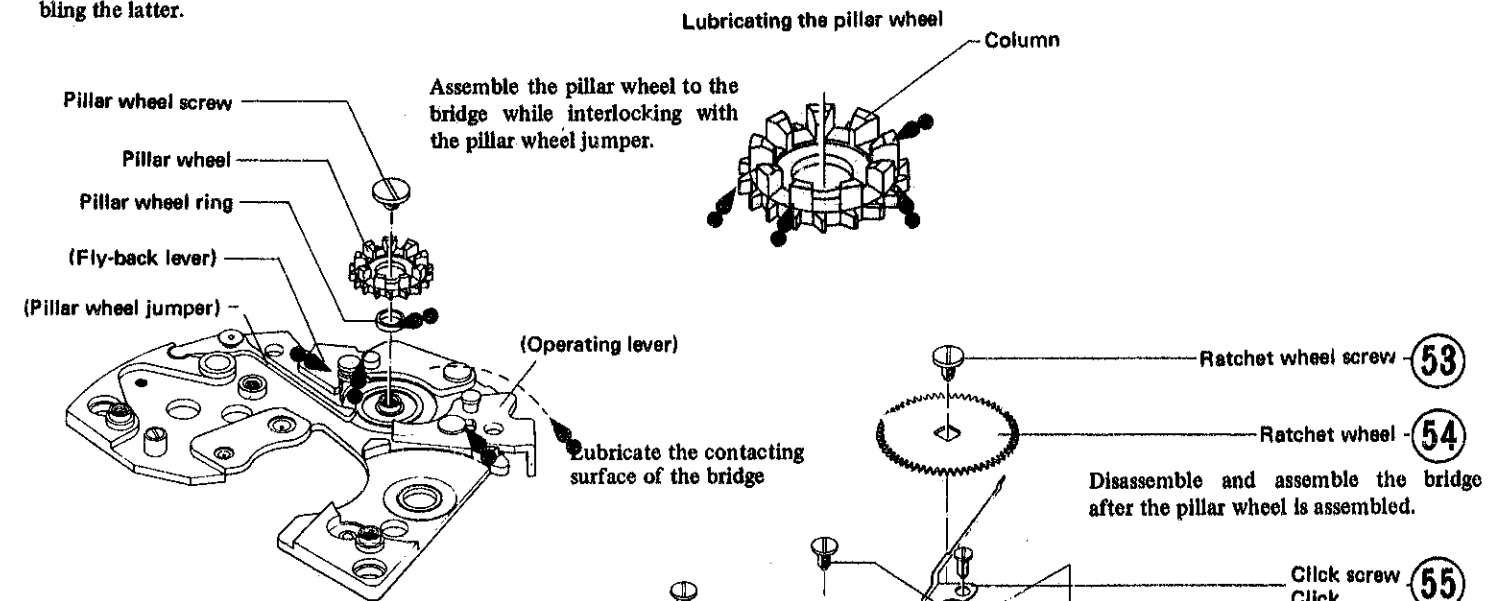

The operating lever, fly-back lever, and pillar wheel jumper are driven into the bridge.

**Lubricating the fourth wheel and pinion:**  
Set the center chronograph wheel on the staking tool as shown in the diagram; then lubricate the fourth wheel and pinion while depressing the wheel with a pair of tweezers.

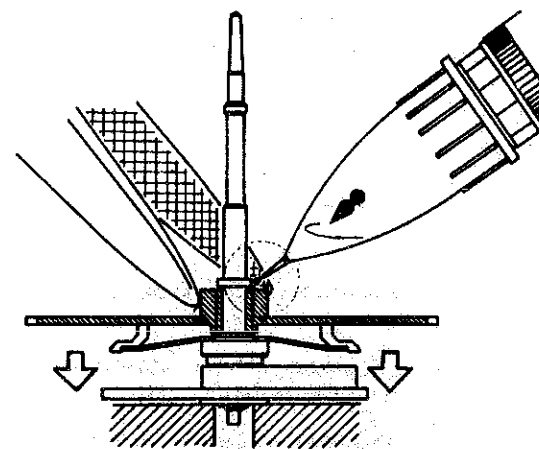

(Fig. 11)

Lubricating the pillar wheel

Assemble the pillar wheel to the bridge while interlocking with the pillar wheel jumper.

Lubricate the contacting surface of the bridge

Disassemble and assemble the bridge after the pillar wheel is assembled.

When disassembling and assembling the bridge, pay attention not to deform the clutch spring, chronograph finger and the fourth wheel and pinion.

Pay attention to the center chronograph wheel while handling it.

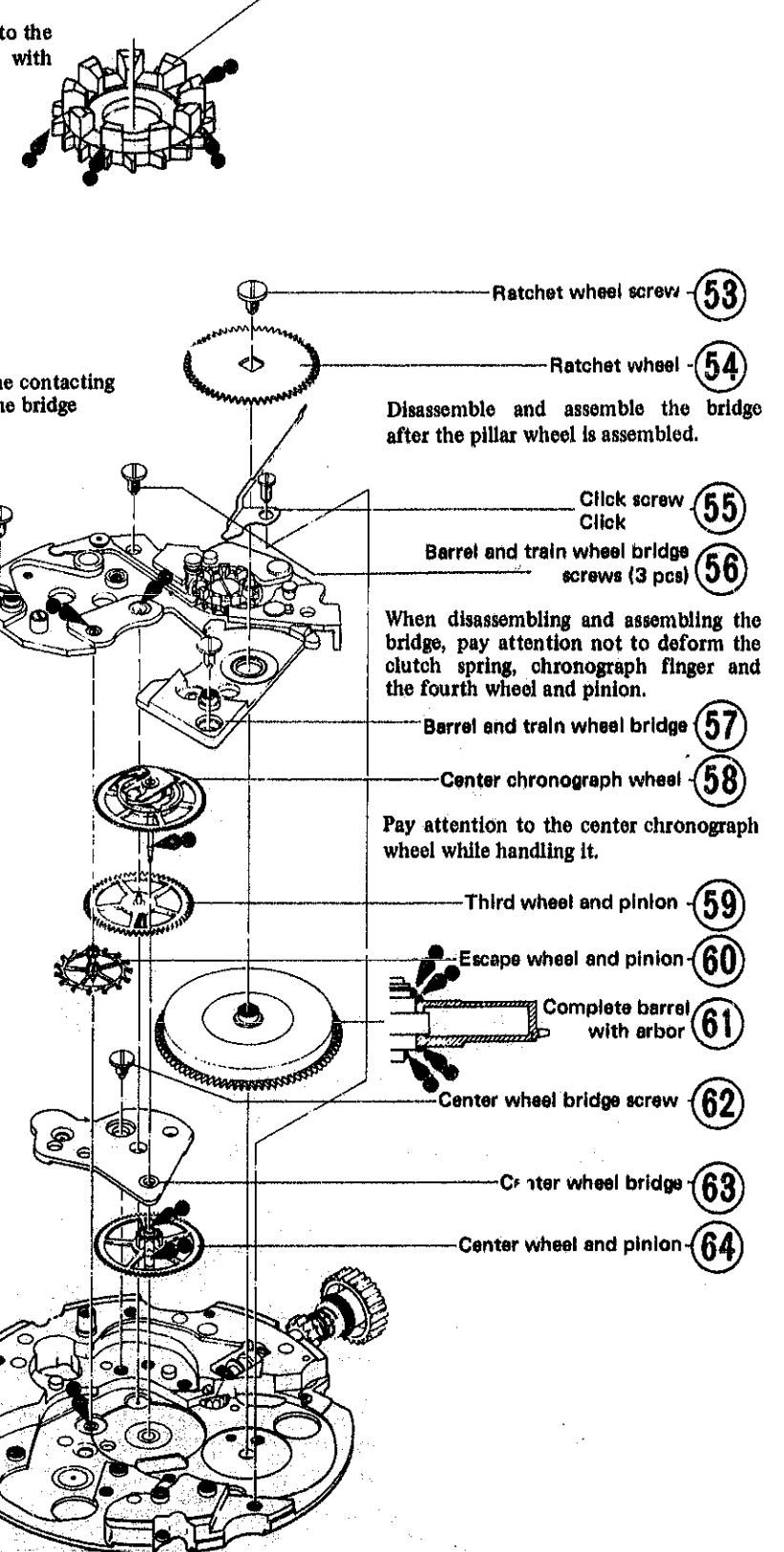

## 6139A Setting Mechanism

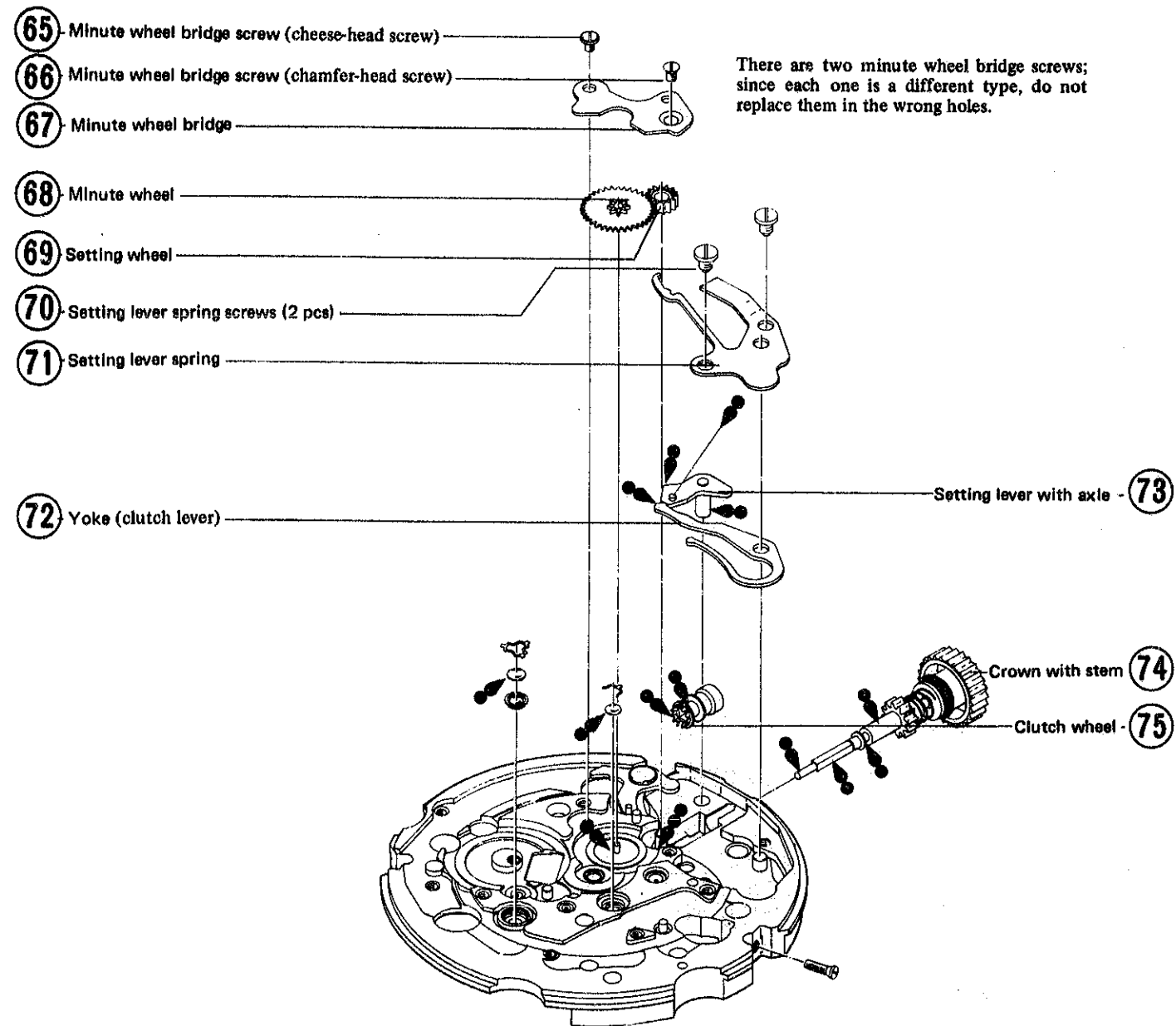

## 6139A Checking and Adjusting the Chronograph Mechanism-I

### I. Checking and adjusting the coupling levers

- When the up and down interlocking condition between the coupling levers and clutch ring is incorrect, it will cause various troubles such as damage to clutch spring (when interlocked deeper), halting, or free run (when interlocked shallower). Remedy by effecting the following procedures.

#### Checking:

- Confirm that the coupling lever's Point B comes to a lower level than the clutch ring's Point A when kept at "run" and the bridge side is turned up.
- Raise the fourth wheel and pinion while in a stopped condition, confirming that the clutch ring and fourth wheel are completely separated. (Fig. 13)

#### Adjusting:

Adjust vertical positioning of the upper and lower hole jewel of center chronograph wheel.

- Clearance of coupling levers and clutch ring.

#### Checking:

Clearance between clutch ring and first coupling lever and clearance between clutch ring and second coupling lever must be identical (Fig. 14).

#### Adjusting:

Adjust by turning the eccentric pin (\*) of the second coupling lever.

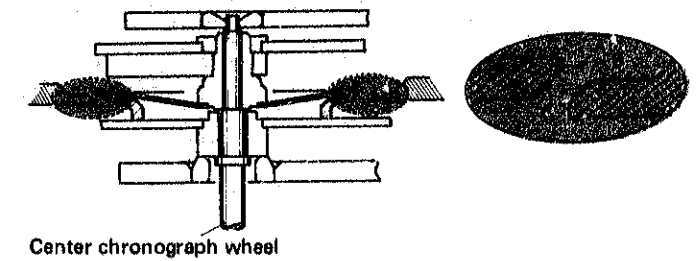

(Fig. 12)

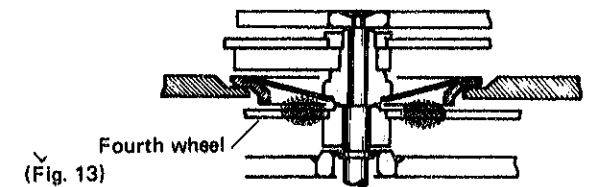

(Fig. 13)

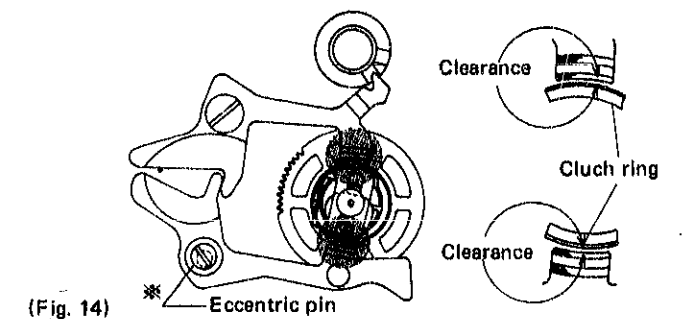

(Fig. 14)

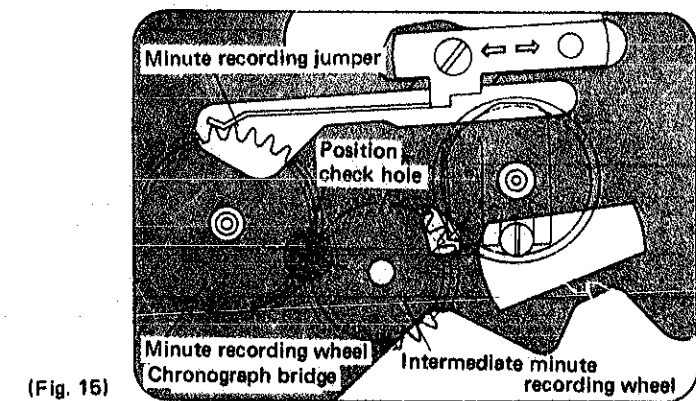

(Fig. 15)

### II. Checking and adjusting minute recording jumper

- Correct positioning of minute recording jumper  
Confirm that the three teeth of minute recording wheel can be observed symmetrically in the position check hole. (Fig. 15)

#### Adjusting:

Loosen the screw, and adjust the minute recording jumper by moving it to the right and left.

- Height of the minute recording jumper

#### Checking:

- Elevation of the minute recording jumper from the upper level of minute recording wheel must be less than half the thickness of the minute recording jumper. (Fig. 16)

(Fig. 16)

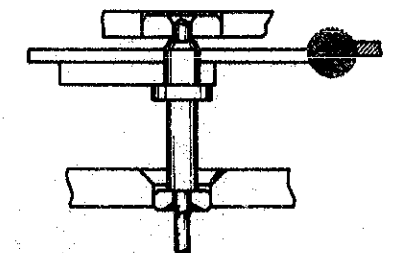



## 6139A Checking and Adjusting the Chronograph Mechanism-2

- (2) By turning the minute recording wheel, confirm that the lower surface of the minute recording jumper does not contact top of the screw of first coupling lever. (Fig. 17)

Adjusting:

Bend the root of minute recording jumper either up or down. (Fig. 18)

### 3. Force of minute recording jumper

Insufficient force of minute recording jumper pressing against minute recording wheel results in retarding advance of the chronograph minute hand at forwarding time in minutes. If the force is too strong, it causes the chronograph minute hand to stop. Pay close attention to this.

Checking:

Check force of the minute recording jumper by strength of the mainspring.

- (1) After completely releasing the mainspring, start it by winding the ratchet wheel just halfway, confirming that the chronograph finger adequately activates the minute recording wheel.

- (2) Confirm that the minute recording jumper precisely regulates advance of the minute recording wheel. (Fig. 19)

Adjusting:

Bend the base of the minute recording jumper in either direction as indicated by arrows. (Fig. 20)

### III. Adjusting the chronograph finger

#### 1. Locking contact of chronograph finger

Checking:

After correctly adjusting the position of minute recording jumper (refer to Adjust II-1), rotate the chronograph finger forward in a stopped condition, checking the degree with which the chronograph finger contacts the intermediate minute recording wheel.

- (1) The amount of such contact should be more than 1/4 but less than 1/2 the size of the flat end of the chronograph finger. (Fig. 21-A).
- (2) The chronograph finger should not touch other teeth on both sides of the tooth contacting the intermediate chronograph wheel.

Adjusting:

First straighten out the chronograph finger spring (the oblique lined stem in Fig. 22); then bend the basic portion (encircled) to effect desirable contact.

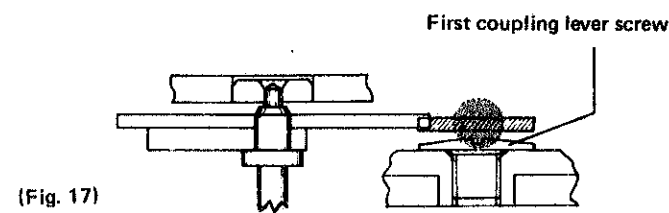

(Fig. 17)

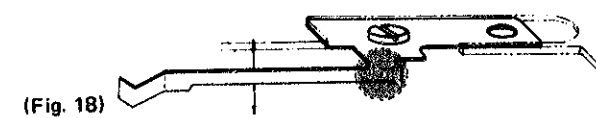

(Fig. 18)

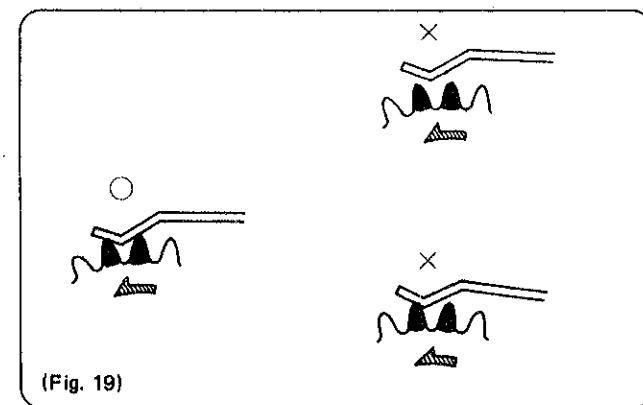

(Fig. 19)

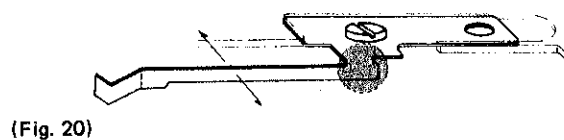

(Fig. 20)

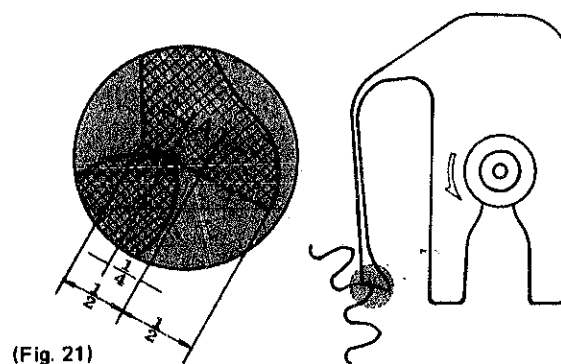

(Fig. 21)

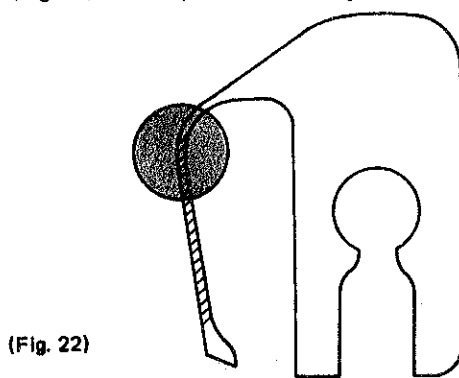

(Fig. 22)

## 6139A Checking and Adjusting the Chronograph Mechanism-3

### 2. Position of the chronograph finger

If the position of the chronograph finger rotating direction is abnormal, forwarding time of the chronograph minute hand becomes defective around the "0" second.

Checking:

After resetting the hands, point C of the chronograph finger must be straight on line between points A and B of the position setting hole. (Fig. 23)

Adjusting:

While keeping the hammer depressed, turn the adjusting pin of chronograph finger attached to the second heart, until the correct position for point C is obtained.

(Note) Be careful to avoid breaking the pivot of center chronograph wheel which sometimes occurs if the pin is pressed too strongly.

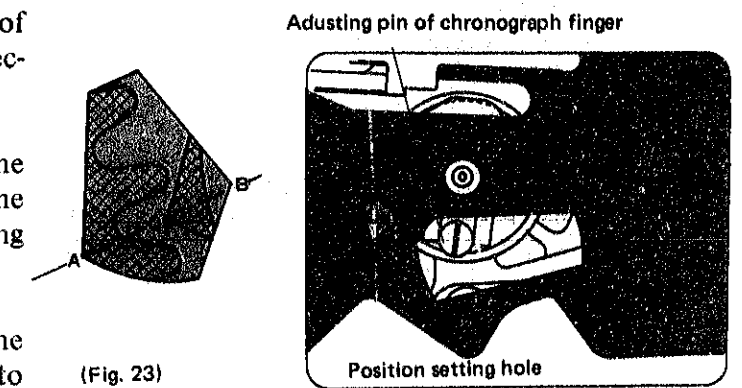

(Fig. 23)

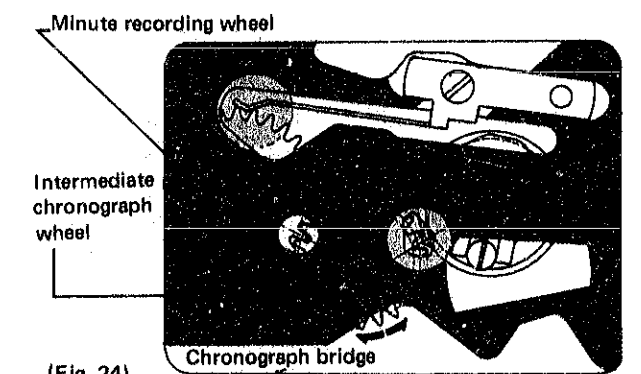

(Fig. 24)

### IV. Checking and adjusting contacting condition of the hammer and hearts

When the hands are reset, there should be no clearance between the setting surface of the hammer and the second heart. Suitable clearance between setting surface of the hammer and the minute heart is 0.02mm. Should the clearance be excessive, the hands will not be reset to the "0" second.

Checking:

Actually, it is difficult to observe clearances between the hearts and the hammer, so clearances should be judged by the degree of shake observed when the intermediate minute recording wheel, minute recording wheel, and center chronograph wheel are reset to their original position. (Fig. 24)

- Adjust clearance between the second heart and the hammer to zero. In a condition that the hammer is depressed (i.e. in a condition that the hearts and the hammer are contacted), no shakes should occur when slightly moving the center chronograph wheel to the right and left.
- Check clearance of the minute heart by rotating the minute recording wheel to the right and left. (Table 1)

- Keep the hammer continuously depressed. Teeth of the intermediate minute recording wheel should not pass over the crest of the chronograph finger.
- Similarly, teeth of the minute recording wheel should not pass over the crest of the minute recording jumper.

	Intermediate minute recording wheel: A		Minute recording wheel: B	
Free condition				
When turning A to the right:				
When turning A to the left:				
Adjustment	—	Polish second setting surface of the hammer	—	Polish second setting surface of the hammer

Table 1

## 6139A Checking and Adjusting the Chronograph Mechanism-4

Adjusting:

When shakes exist in the second heart:

Polish setting surface of the hammer contacting the minute heart.

When shake of the minute heart is excessive (when passing over the crest):

Polish setting surface of the hammer contacting the second heart.

(Note) When polishing the hammer, slightly file the point parallel to the setting surface, finishing to a mirrored surface. (Fig. 25)

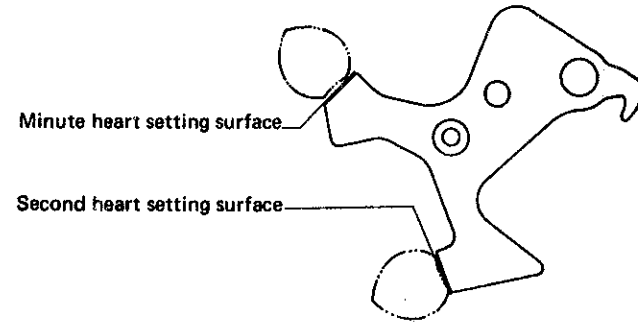

(Fig. 25)

### V. Adjusting pressing strength of the second button (fly-back button)

After installing the movement and the buttons on the case, check pressing strength of the second button.

Adjust pressing strength to the same as that of the first button. When the pressing strength is too strong, it will damage the chronograph mechanism.



(Fig. 26)

Adjusting:  
Bend tip of the hammer click by holding the pit portion. Do this carefully; the parts are apt to be damaged when it is bent too much.

## Repairing the Chronograph Mechanism

### I. Repairing Method

#### 1. Center chronograph wheel—Damage due to:

- (1) Broken clutch spring
- (2) Strength of clutch spring too weak
- ↳ In these cases, the chronograph second hand either fails to move or moves irregularly.
- (3) Broken chronograph finger

Broken chronograph finger does not advance the chronograph minute hand.

If (1), (2) or (3) occur, replace the center chronograph wheel, referring to Checking and Adjusting the Coupling Levers mentioned in item I, Adjusting the Chronograph Finger mentioned in III, and Checking and Adjusting the Contacting Condition of the Hammer and the Hearts mentioned in IV of Chronograph Adjustment.

#### 2. Loose chronograph second hand

If the chronograph second wheel does not reset to the "0" position when depressing the button, confirm the following point.

Check if the second hand moves when the second button is pressed. If it moves, the cause is due to loose contact of the second hand and center chronograph wheel axle. To correct this, reinsert the second hand to the extent that does not cause second hand catching.

#### 3. Poor revolving efficiency of the fourth wheel

If the gear-train is not functioning well in a stopped condition, repair the watch after confirming the following points:

- (1) Check for correct shakes
- (2) Check for friction between each wheel
- (3) Check for correct revolving condition of the fourth wheel

As to confirming item (3), first install the chronograph bridge in a condition that the coupling levers are secured to the barrel and train wheel bridge. Next, as shown in Fig. 27, set the fourth wheel in a starting condition with the bosom side of the barrel and train wheel bridge built in the chronograph bridge upward. Next, after confirming clearance between the fourth wheel and clutch ring in a stopped condition, turn the fourth wheel and pinion with a soft brush to check whether or not it turns smoothly. If revolution is defective, clean and lubricate it (refer to Fig. 11) and reconfirm operation.

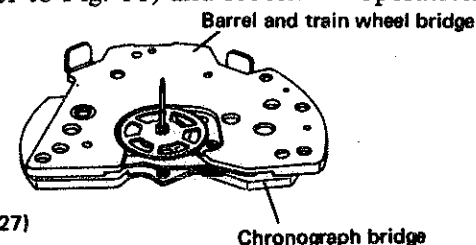

(Fig. 27)

# 6139A After-Sales Service-Trouble-Shooting

The chronograph mechanism is very precisely constructed. When repair is requested, it is important to listen to the customer describe the watch condition. Further, it proves especially valuable in ensuring correct repair to classify the

cause according to the following table, based on details described by the customer. Listing malfunctions in the chronograph mechanism, their causes, and corrective actions, this table can be used effectively.

Mechanisms	Phenomena	Causes	Corrective action
Starting stopping mechanism	First and/or second buttons do not move	Button gasket worn out	
		Dust adhered around button axle	
		Lack of silicon grease	
	Mechanism does not start even when depressing button	Deeper than necessary interlocking of chronograph finger . . . . .	Refer to Chronograph Adjusting III-1
		Damaged center chronograph wheel . . . . .	Refer to Chronograph Repairing I
		Unsmooth operation of first and second coupling levers	
	Defective forwarding time of chronograph minute hand	Defective position of minute forwarding . . . . .	Refer to Chronograph Adjusting III-2
		Loosened chronograph second hand . . . . .	Refer to Chronograph Repairing I
	Chronograph minute hand only moves in middle of graduation	Shallow interlocking of chronograph finger . . . . .	Refer to Chronograph Adjusting III-1
		Weak minute recording jumper . . . . .	Refer to Chronograph Adjusting II-3
Detached minute recording jumper . . . . .		Refer to Chronograph Adjusting II-2	
Malfunction of intermediate minute recording wheel turning			
Chronograph minute hand stops in forwarding condition	Deep interlocking of chronograph fingers . . . . .	Refer to Chronograph Adjusting III-1	
	Strong minute recording jumper . . . . .	Refer to Chronograph Adjusting II-3	
	Detached minute recording jumper . . . . .	Refer to Chronograph Adjusting II-2	
	Insufficient amplitude		
Chronograph minute hand not being forwarded	Damaged center chronograph wheel . . . . .	Refer to Chronograph Repairing I	
	Shallow interlocking of chronograph wheel . . . . .	Refer to Chronograph Adjusting III-1	
Chronograph minute hand forwarded simultaneously with starting	Defective chronograph finger position . . . . .	Refer to Chronograph Adjusting III-2	
Hands do not stop even when depressing first button to stop position	Damaged center chronograph wheel . . . . .	Refer to Chronograph Repairing I	
	Clutch spring raises only slightly . . . . .	Refer to Chronograph Adjusting I-1	
Resetting mechanism	Defective pressing condition of buttons	Abrased button gasket	
		Lack of silicon grease	
		Weak hammer click . . . . .	Refer to Chronograph Adjusting V
		Lack of oil on fly-back lever pin	
	Second hand does not reset to the "0" position	Deep interlocking of chronograph finger . . . . .	Refer to Chronograph Adjusting III-1
		Loosened chronograph second hand . . . . .	Refer to Chronograph Repairing I
		Abrased hammer . . . . .	Refer to Chronograph Adjusting IV
	Chronograph minute hand does not reset to the "0" position	Deep interlocking of chronograph finger . . . . .	Refer to Chronograph Adjusting III-1
		Weak minute recording jumper . . . . .	Refer to Chronograph Adjusting II-3
		Detached minute recording jumper . . . . .	Refer to Chronograph Adjusting II-2
Excessive shakes of minute heart and hammer . . . . .		Refer to Chronograph Adjusting VI	
Hands do not reset even when depressing the second button	Damaged fly-back lever pin		
Defective durability	No durability in starting condition	Deep interlocking of chronograph finger . . . . .	Refer to Chronograph Adjusting III-1
		Damaged center chronograph wheel . . . . .	Refer to Chronograph Repairing I
		Strong minute recording jumper . . . . .	Refer to Chronograph Adjusting II-3
	No durability in stopping condition	Insufficient amplitude	
		Friction of fourth wheel	
Defective rotating condition of fourth wheel . . . . .	Refer to Chronograph Repairing I		
Insufficient amplitude			

## 6139A CHECKING ON WATCH STOPPING, AND REPAIRING AND ADJUSTING PROCEDURES

---

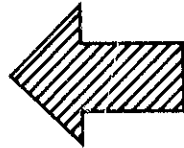

Regarding repairing and adjusting of Cal. 6139A, we have already mentioned them in the SEIKO TECHNICAL GUIDE. However, on these pages, items to be checked on watch stopping, and repairing and adjusting for each item, are compactly arranged to facilitate further comprehension.

### EXPLANATIONS REGARDING WATCH STOPPING AT 58 SECOND POSITION

- A watch stopping at 58 second position is not malfunctional.

When the mainspring winding is insufficient the second hand always stops at the 58 second position.

But this is not a malfunction.

- The reason why a watch stops at 58 second position:

In the 6139A, when the second hand moves from 58 to 60 second, the mechanism is devised so that the chronograph minute hand moves one graduation. At the 58 second position where the chronograph minute hand moves, a larger mainspring force is required.

Consequently, when the mainspring is nearly unwound, 6139A always stops at the 58 second position.

- A watch in the following condition is defective.

When the second hand stops at the 58 second position in spite of a fully wound mainspring, the watch is defective. Repair and adjust it according to the following procedures.

1. Items to be checked before beginning repair works.

\* Checking the number of remaining windings of the mainspring

2. When the balance stops at the 58 second position.

3. When the second hand stops at the 58 second position and the balance is still moving.

# 6139A CHECKING ON WATCH STOPPING, AND REPAIRING AND ADJUSTING PROCEDURES

(Example of stopping at 58 second position)

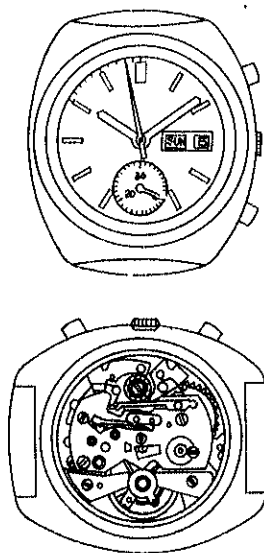

## 1 Confirm the Following Items Before Beginning Repair Work

- Check \*the number of remaining windings of the mainspring of the watch, of which the second hand stops at the 58 second position as shown in the above diagram.
- In this case, when the number of remaining windings of the mainspring is.....  
 More than 1 - 1.5 windings..... Adopt Procedure 2  
 Under 1 winding..... Adopt Procedure 3

### \*Checking the number of remaining windings of the mainspring

- Remove the automatic winding section (oscillating weight section).
- Firmly hold the ratchet wheel screw with a driver and release the click by using a pair of tweezers.
- In this condition, gradually turn the ratchet wheel screw counterclockwise until the mainspring power is exhausted (releasing the mainspring).
- This revolving number of the ratchet wheel screw corresponds with the number of remaining windings of the mainspring.

(Note)

It is convenient to count the number of remaining windings of the mainspring by confirming the direction of the groove of the ratchet wheel screw.

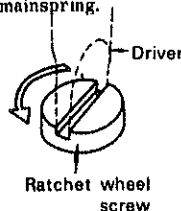

[When the number of remaining windings of the mainspring exceeds 1 - 1.5 windings]

## 2 When the Balance stops at the 58 second Position

In this case, inspect the watch according to CHECKING PROCEDURES 4 through 6 after removing the case back and the automatic winding section (oscillating weight section).

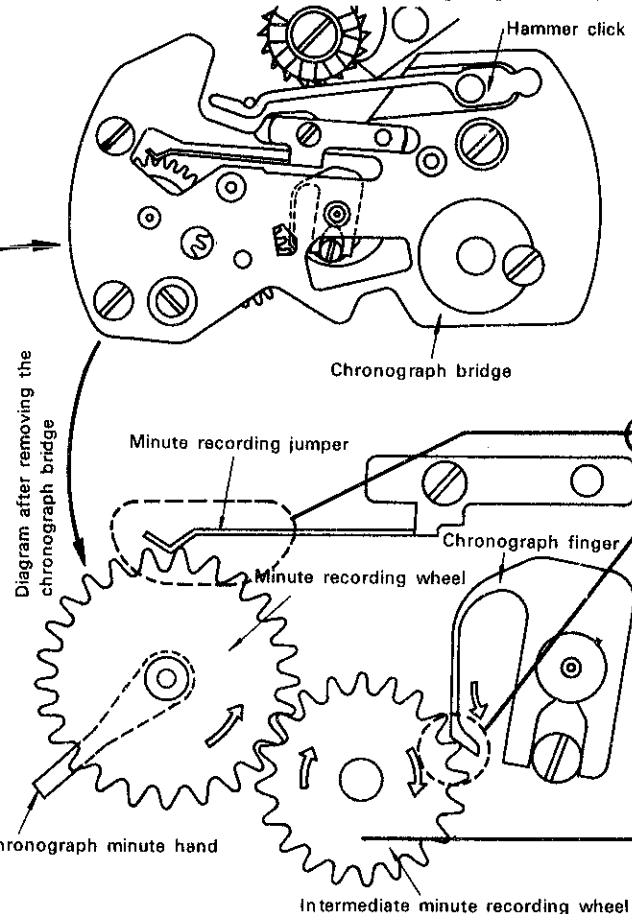

[When the number of remaining windings of the mainspring is under 1 winding]

## 3 When the Second Hand stops at the 58 second Position and the Balance is Still Moving

In this case, inspect the watch according to CHECKING PROCEDURE 7.

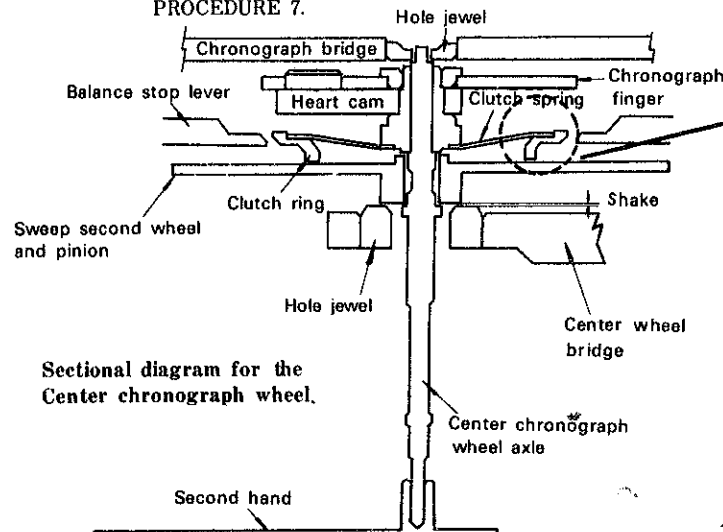

Checking procedure	Checking details	Repairing and checking methods									
4	<p>Check the condition when the chronograph finger contacts the intermediate minute recording wheel (when the minute forwarding is ready to start).</p>	<p>In case of X Adjust the amount which the chronograph finger contacts with the wheel by bending this portion in the → or ← direction, holding it with a pair of tweezers.</p> <p>The amount of such contact (θ) should be more than 1/4 but less than 1/2 the size of L.</p>									
5	<p>Check whether or not teeth of the minute recording wheel are forwarded by winding the ratchet wheel only half a revolution after completely releasing the mainspring.</p> <table border="1"> <thead> <tr> <th>At 58 - 59 second</th> <th>At 60 second</th> <th>Judgment</th> </tr> </thead> <tbody> <tr> <td></td> <td></td> <td>O</td> </tr> <tr> <td></td> <td>(Stopping)</td> <td>X</td> </tr> </tbody> </table> <p>Cannot be forwarded because the spring of the minute recording jumper is too strong</p>	At 58 - 59 second	At 60 second	Judgment			O		(Stopping)	X	<p>In case of X, create a forwarding condition by winding the ratchet wheel only half a revolution after completely releasing the mainspring. To satisfy both following ① and ②, adjust strength of the minute recording jumper spring.</p> <ol style="list-style-type: none"> <li>Minute forwarding is correctly performed between 58 and 60 second position.</li> <li>After performing minute forwarding, chronograph finger always must be geared correctly into the wheel.</li> </ol> <p>Adjust strength of the minute recording jumper spring by bending this portion in the ↑ or ↓ direction.</p> <p>(Note) When the minute is not forwarded in spite of weakening the strength of minute recording jumper, first check and correct the watch according to Procedure 6; then adjust strength of the minute recording jumper.</p>
At 58 - 59 second	At 60 second	Judgment									
		O									
	(Stopping)	X									
6	<p>Remove the chronograph bridge and check on revolving condition of the intermediate minute recording wheel.</p> <p>Lightly turn the intermediate minute recording wheel with a soft small brush.</p> <p>Turns lightly ..... O Turns heavily ..... X</p>	<p>When the intermediate minute recording wheel turns heavily (X), wash the chronograph bridge with an ultrasonic cleaner.</p> <p>(Note) Never lubricate the intermediate minute recording wheel.</p>									
7	<p>[When the second hand stops at the 58 second position and the balance is still moving, the cause is due to slipping of the clutch ring.]</p> <p>(Note) If the shake of the center chronograph wheel is excessive, the second hand moves intermittently in spite of stopping condition. Adjust the shake properly (the shake is proper when it is almost the same as ordinary wheel's).</p>	<p>Remove the center chronograph wheel and sufficiently wash it; then lubricate between the fourth wheel and the center chronograph wheel axle with Moebius Synt-A-Lube. Confirm the moving condition of the clutch. When the clutch is loosened, replace the center chronograph wheel with a new one. In this case, properly adjust shake of the new center chronograph wheel.</p> <p>Adjust the shake by raising or lowering this hole jewel. (Adjust it on a staking tool or a riveting-stake).</p>									

### General Checking Procedures After Repairing

#### 1. Pushing strength of the hammer button

When pushing strength of the hammer button is too heavy, the second hand is reset too fast, causing a defective resetting position. Consequently adjust it lightly as far as possible.

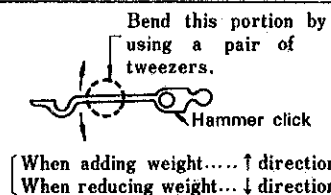

#### 2. Clearance between hands

When the clearance between the second hand and the minute hand is too narrow, sometimes the second hand scratches the minute hand when resetting. Always check the clearance between the hands.

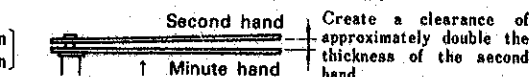

(Note) When installing the second hand, use the movement holder (S-500) for 6139A.

## Checking, Repairing and Adjusting Methods for Slipping of Chronograph Second Hand at the Fly-Back Position of Cal. 6138A and 6139A

---

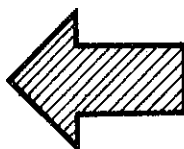

Checking, repairing, and adjusting methods of watch stopping at 58 second position of Cal. 6139 have been explained in detail in 6139A-14. On these pages, only slipping of chronograph second hand at the fly-back position is described.

When you are requested to repair slipping of the fly-back position, please refer to the following procedures.

Explanations in these pages can be utilized in common to both 6138A and 6139A.

- Check Points Before Starting Repair
  
- When Chronograph Second Hand does not Return to "0" Position
  
- When Both Chronograph Second Hand and Minute Hand do not Correctly Return
  
- Overall Check Points after Repair

# Checking, Repairing and Adjusting Methods for Slipping of Chronograph Second Hand at the Fly-Back Position of Cal. 6138A and 6139A

If the chronograph second hand does not return to the "0" position when pushing the fly-back button (2nd button), confirm that the condition is Case 1 or Case 2, before repairing.

## 1 When the Chronograph Second Hand Does Not Return to "0" Position

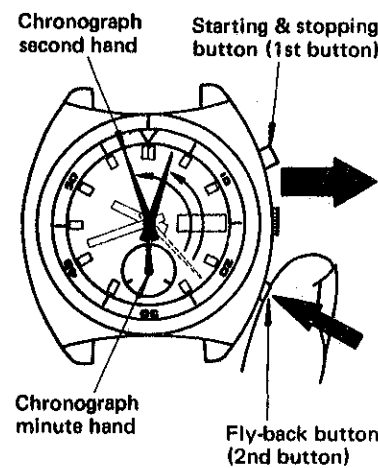

## 2 When both Chronograph Second Hand and Minute Hand Do Not Correctly Return

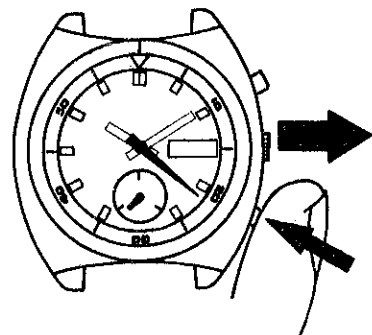

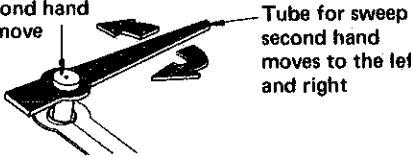
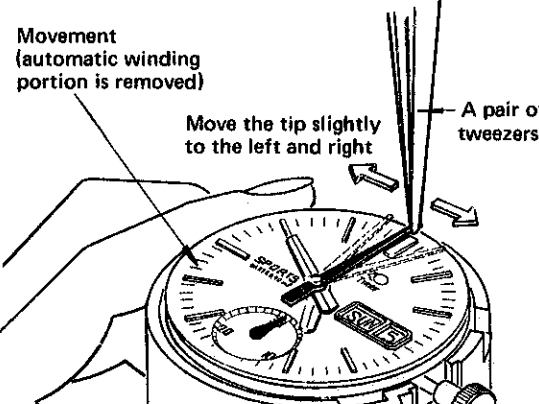
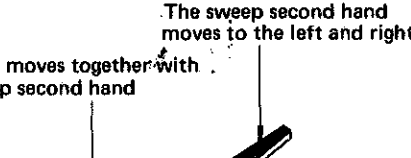
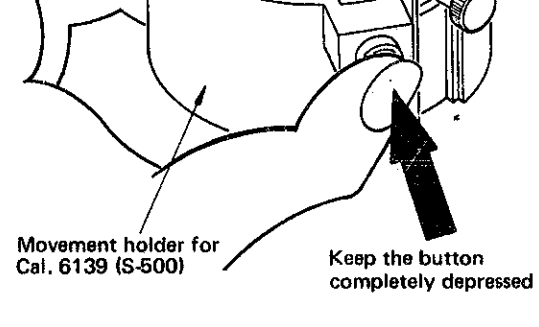
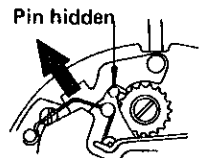
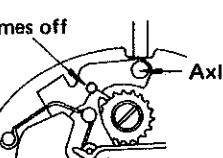
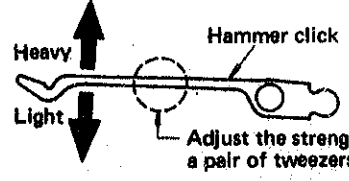
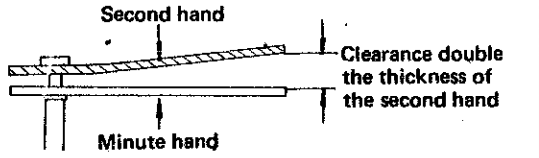
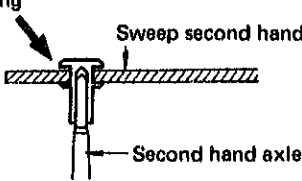
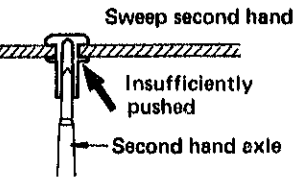
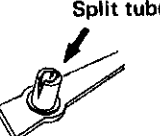
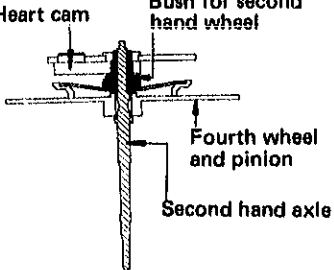
Check Poits	Repaing and Adjusting Methods
<p>Hold the tip of the chronograph second hand with a pair of tweezers and move it slightly to the left and right while keeping the fly-back button completely depressed.</p>	<p>1. When only the sweep second hand moves while the tube for sweep second hand does not move.</p> <p>Sweep second hand does not move</p> <p>Tube for sweep second hand moves to the left and right</p> 
<p>Movement (automatic winding portion is removed)</p> <p>Move the tip slightly to the left and right</p> <p>A pair of tweezers</p> <p>Keep the button completely depressed</p> 	<p>2. When the sweep second hand and the tube for sweep second hand move together</p> <p>The sweep second hand moves to the left and right</p> <p>The tube moves together with the sweep second hand</p> 
<p>Remove the automatic winding section and check the position of a fly-back lever pin.</p> <p>Note: The diagram show normal condition.</p> <p>Fly-back lever pin</p> <p>Fly-back lever</p> <p>Hammer</p> <p>Hammer click</p> 	<p>1. When the fly-back lever pin is hidden under the hammer</p> <p>Pin hidden</p>  <p>2. When the fly-back lever pin comes off</p> <p>Pin comes off</p> <p>Axle</p> 
<p>1. Pushing strength of the hammer button Recommended pushing strength of the fly-back button is the same as that of the starting and stopping button. If the strength is too heavy, the second hand is returned so quickly that the fly-back position may slip.</p> <p>Heavy</p> <p>Light</p> <p>Hammer click</p> <p>Adjust the strength by bending this portion with a pair of tweezers.</p> 	<p>2. Clearance between second hand and minute hand Create clearance double the thickness of the second hand between the second hand and the minute hand. After completely pushing in the second hand, adjust the clearance by bending the second hand upward.</p> <p>Second hand</p> <p>Minute hand</p> <p>Clearance double the thickness of the second hand</p> 
<p>This is caused by a slip between the sweep second hand and the tube for sweep second hand as shown in the diagram on the right.</p> <p>In this case, replace it with a new chronograph second hand.</p> <p>Slipping</p> <p>Sweep second hand</p> <p>Second hand axle</p> 	<p>*(a) Insufficient installation of the second hand may cause this malfunction. First, completely push the second hand, and then recheck the fly-back position of second hand.</p> <p>If this method is not effective, make a check (b).</p> <p>Sweep second hand</p> <p>Insufficiently pushed</p> <p>Second hand axle</p> 
<p>(b) Detach the second hand and check the tube for sweep second hand</p> <p>* If the tube hole is enlarged too much or split as shown in the diagram on the right, replace it with a new sweep second hand.</p> <p>Split tube</p> 	<p>(c) If the above-mentioned methods (a) and (b) are not effective, it may be caused by a slip between the bush for second hand wheel of the center chronograph wheel (in red color) and the second hand axle (oblique lines portion). In this case, replace it with a new center chronograph wheel. At the same time, adjust the chronograph finger.</p> <p>Note: For details, refer to 6139A-9</p> <p>Heart cam</p> <p>Bush for second hand wheel</p> <p>Fourth wheel and pinion</p> <p>Second hand axle</p> 

### Overall Check Points After Repair

### (Reference) Installation Method of Chronograph Second, Minute, and Hour Hands

- Pushing strength of the hammer button  
Recommended pushing strength of the fly-back button is the same as that of the starting and stopping button.  
If the strength is too heavy, the second hand is returned so quickly that the fly-back position may slip.

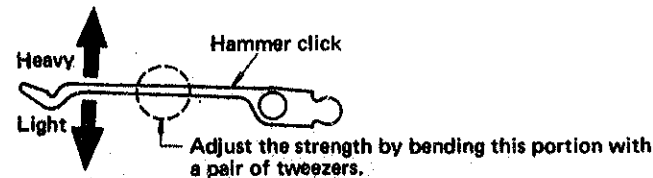

- Clearance between second hand and minute hand  
Create clearance double the thickness of the second hand between the second hand and the minute hand. After completely pushing in the second hand, adjust the clearance by bending the second hand upward.

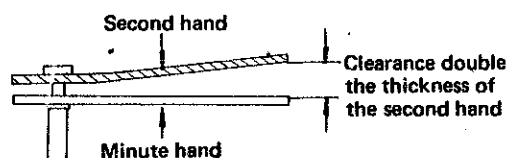

- After removing the automatic winding section, set the movement on the movement holder (S-500) for Cal. 6139.
- After setting the second hand (or chronograph minute and hour hands) at the "0" position, push it in lightly while keeping the fly-back button completely depressed. (Fig. 1)
- After confirming the fly-back position of the second hand, completely push in the second hand.

Note: Since the tip of the center chronograph wheel is shaped as shown in Fig.2, the second hand will be loosened when it is moved to the right and left after completely setting it.

Fig. 2

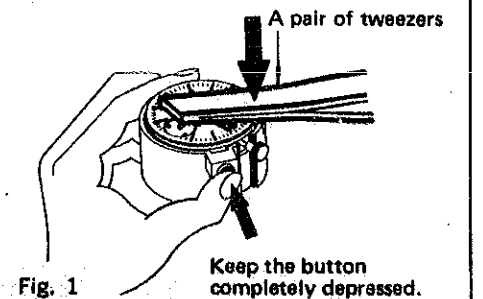

Fig. 1

Keep the button completely depressed.

# 6139A Automatic Chronograph

## 1 Specifications

Casing diameter	27.00 mm
Height	6.65 mm
Vibrations per hour	21,600
Automatic winding	
Calendar (Day & date, bilingual change-over mechanism for day indication, instant day & date setting device)	
Chronograph (1/5 second, one revolution in 60 seconds, 30 minutes totalizer, accumulated)	

## 2 Features

An advanced automatic winding chronograph

6139A Automatic Chronograph is a high-grade functional watch in which a chronograph mechanism and an automatic winding mechanism are compactly assembled. Addition of a calendar mechanism does not affect watch size and thickness. Easy-to-use chronograph mechanism

The second hand and minute recorder can be activated by depressing the first button. Measured time can be accumulated just as with a regular chronograph.

Either one of two languages provided can be chosen to indicate the days of the week.

### Numerous function and design features

In addition to 30- to 70-meter depth waterproofing (70-meter depth waterproof watch employs HARDLEX special reinforced glass), a variety of functions are provided such as tachymeter, pulsimeter, and rotating dial ring.

## 3 Disassembly and assembly

Disassemble the watch according to Figs. ①→⑭

①→⑭

Assemble by reversing the above: Figs. ⑭→①

⑭→①

Installation of the automatic winding mechanism varies compared with conventional watches.

The automatic winding mechanism should be installed after setting the movement with hands in the case.

## 4 Lubrication

Colored symbols in the illustrated figures indicate the types of oil, its quantities to be applied, and lubricating points.

- Moebius Synt-A-Lube
- Seiko watch oil S-4

### Oil quantity

- Extremely small quantity
- Normal quantity
- Sufficient quantity
- ⊗ Oil must not be applied

Note: Unindicated portions do not require lubrication.

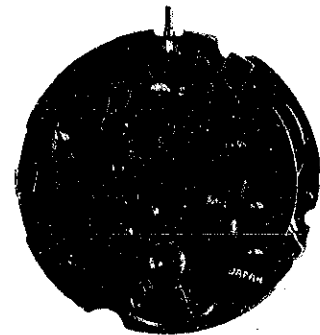
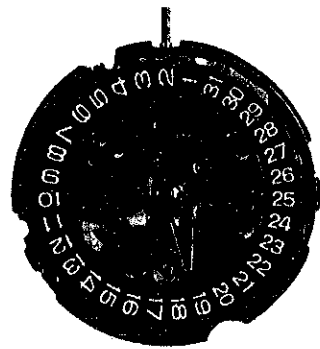

Movement

## 6139A Automatic Winding Mechanism

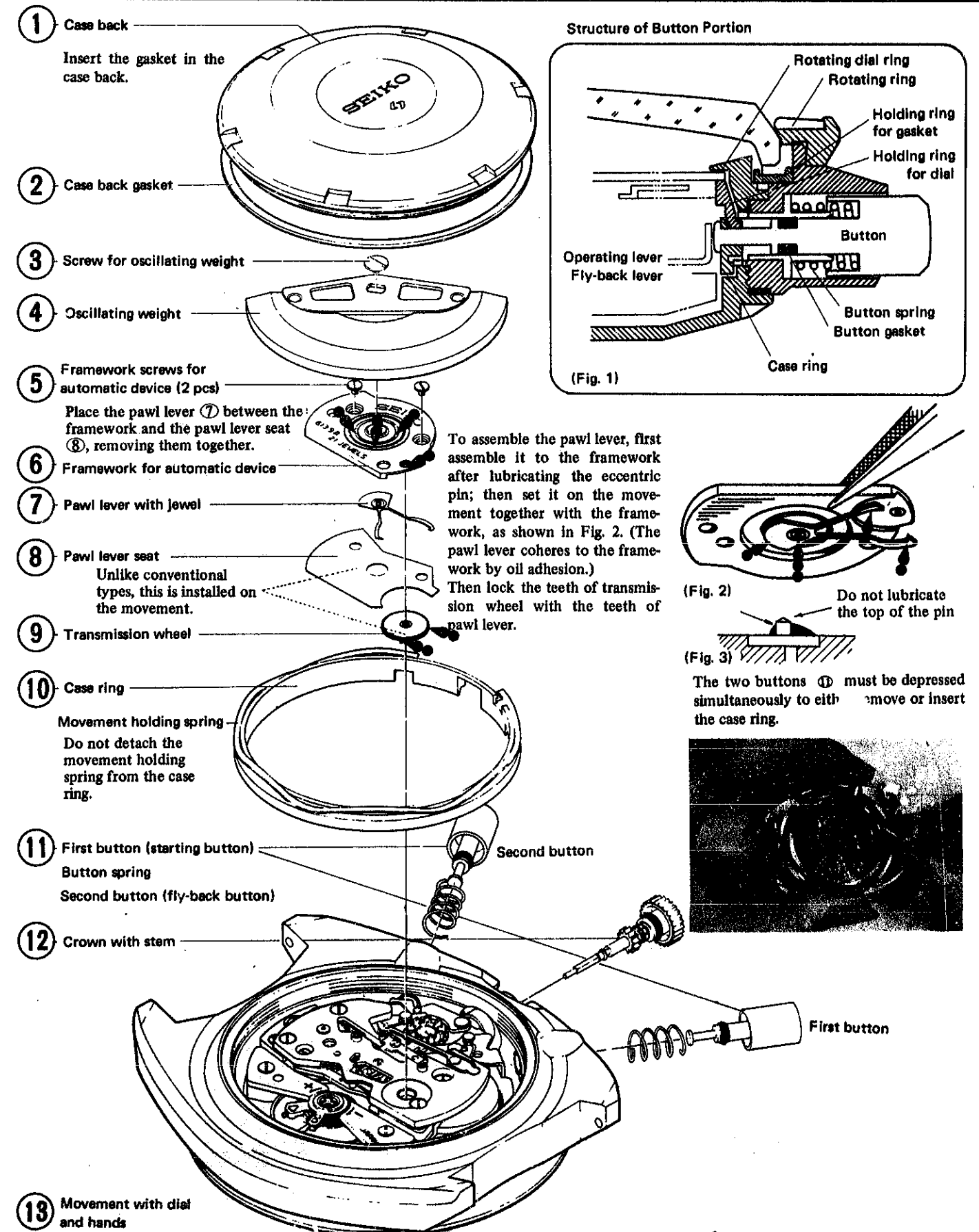



## 6139A Calendar Mechanism

### <Installing the second hand and chronograph minute hand>

- (1) At the fly-back position, tentatively set the hands on the "0" position.
- (2) Then repeat fly-back operation to foolproof the "0" position. If the hands fail to resume correct position, adjust the hands while depressing the fly-back button.
- (3) Completely push in hands at the point where they correctly indicate the "0" position.

#### NOTE:

The second hand axle is cut as shown in the diagram. If the second hand is turned by force after completely depressing it to the bottom, the hand will loosen.

SEIKO provides a handy Movement Holder S-500 exclusively for 6139A, to facilitate hand-setting.

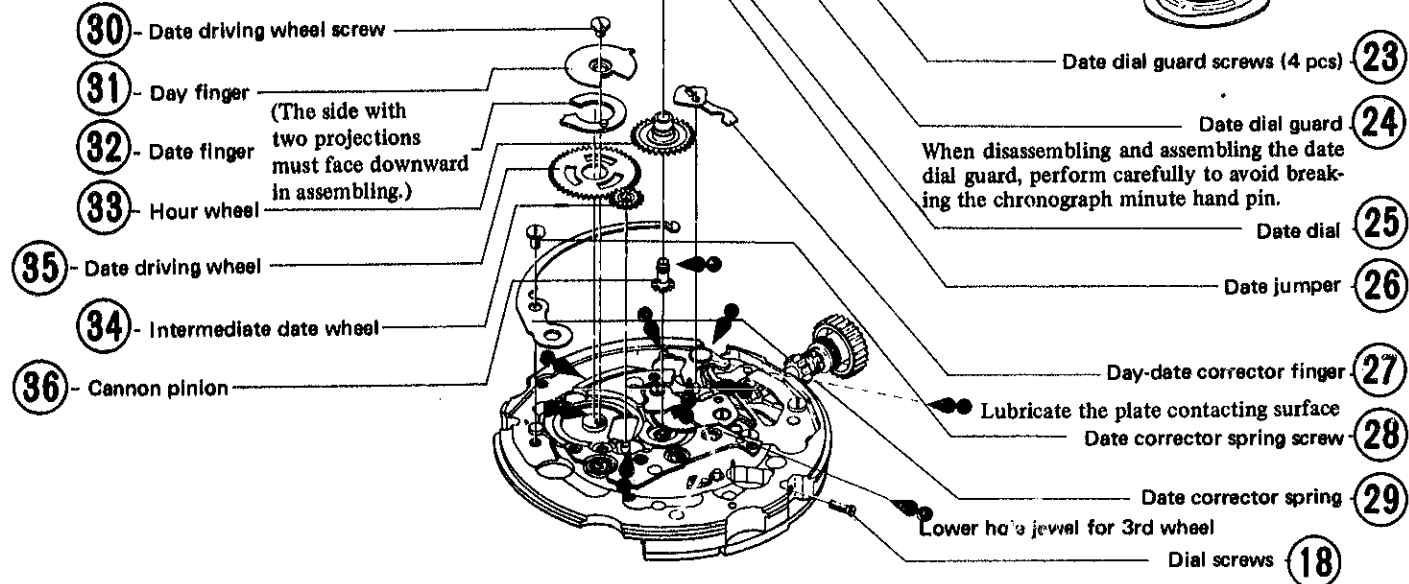
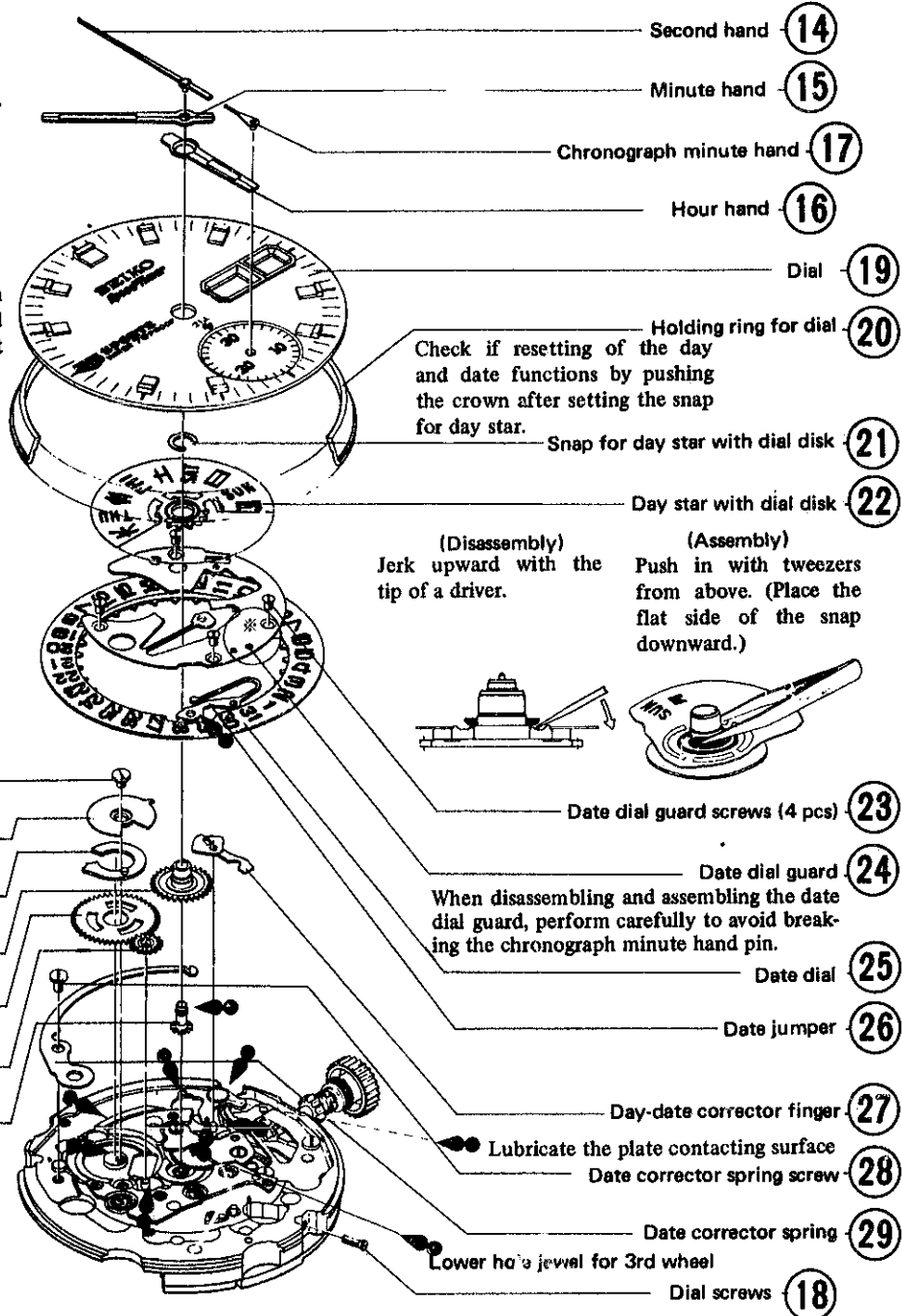
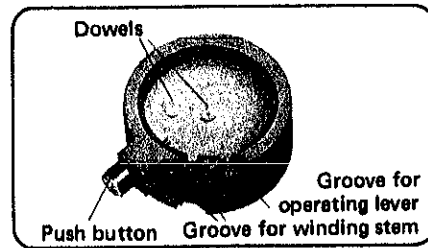

### Calendar Mechanism

#### Day and date correction:

When fully depressing the crown from the ordinary position, the day and date are quickly forwarded by interlocking of stem, setting lever, date corrector, and day-date corrector finger.

#### Date correction:

When stopping the crown at an intermediate position, only the date changes.

#### Day correction:

Further depress the crown from the intermediate position to change only the week day indicated in English (or the other language being used). Once set, only the chosen language appears daily.

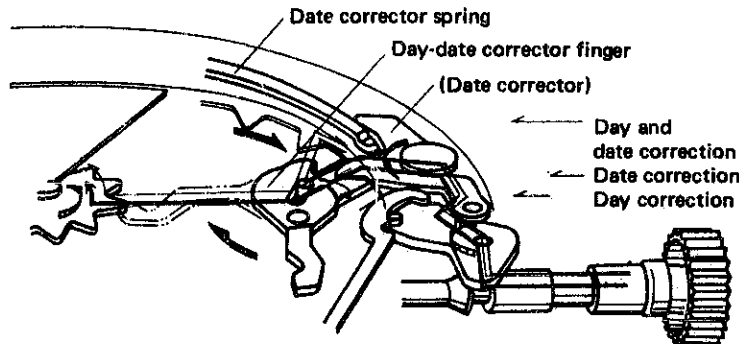

## 6139A Chronograph Mechanism,

1. Items to be checked before assembling the jewelled pallet fork and staff, after setting the chronograph bridge.
  - (1) Confirm that free running force is transmitted unaffectedly. Even though no roll back motion exists, as long as it functions smoothly there is no problem.
  - (2) Check for meshing condition of the first and second coupling levers (6139A-8).

2. Items to be checked after assembling the balance
  - (1) Check for strength and Reight of the minute recording jumper (6139A-8).
  - (2) Check for meshing position of the chronograph finger (6139A-9).
  - (3) Check for contacting condition of the hammer and hearts (6139A-10).

- 37 - Balance cock screws (2 pcs)

- 38 - Balance cock

- 39 - Balance complete with stud

- 40 - Pallet cock screws (2 pcs)

- 41 - Pallet cock

- 42 - Jewelled pallet fork and staff

Be sure to remove the pallet cock and chronograph bridge after unwinding the mainspring.

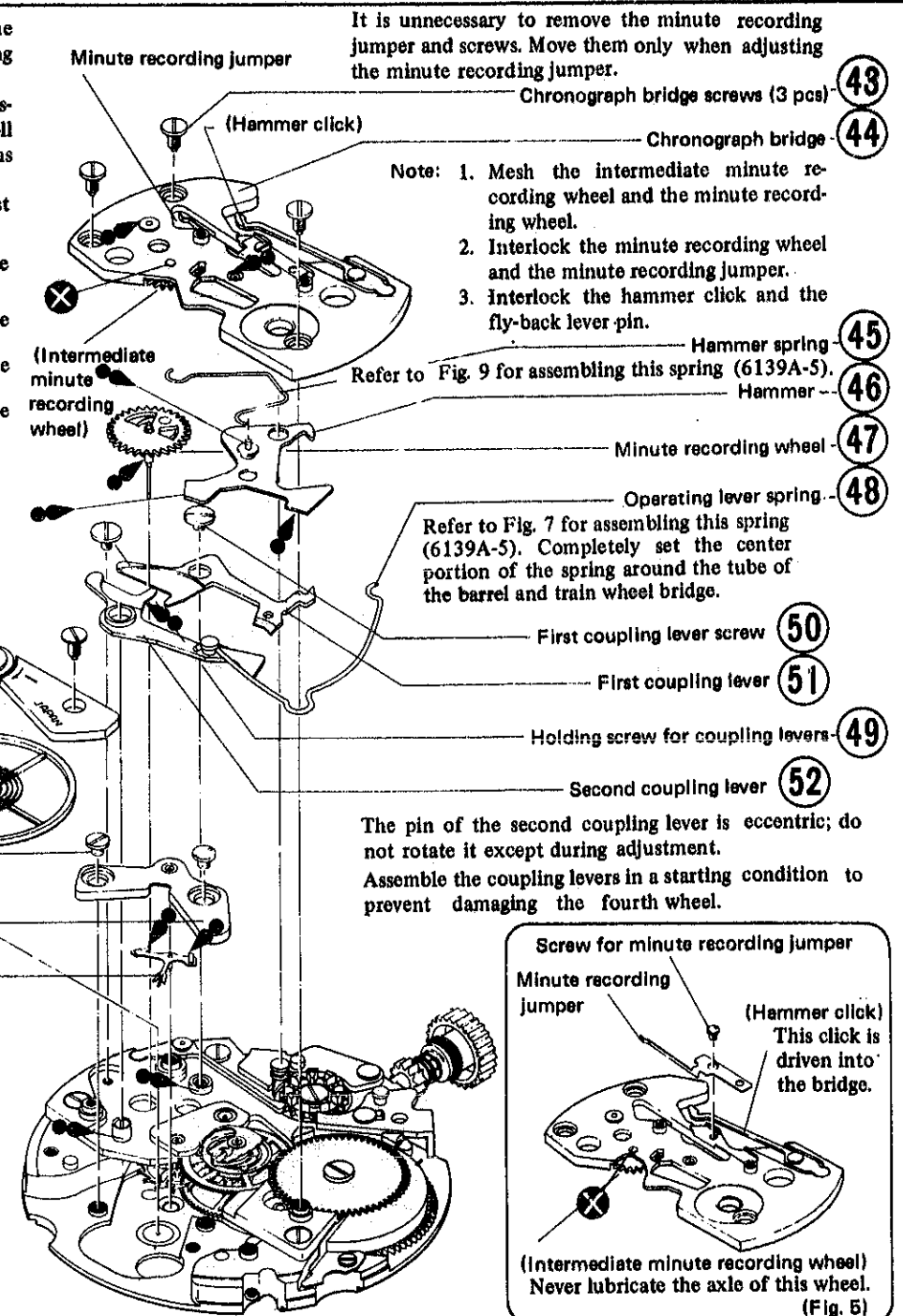

### Center Chronograph Wheel

The center chronograph wheel is composed of the fourth wheel and pinion, clutch ring, clutch spring, second heart, and center chronograph wheel axle having a chronograph finger.

While the clutch ring is pressed to the fourth wheel by a clutch spring, the fourth wheel and center chronograph wheel axle revolve as one body. When the clutch ring is separated from the fourth wheel, the center chronograph wheel axle comes to a halt, and only the fourth wheel revolves individually.

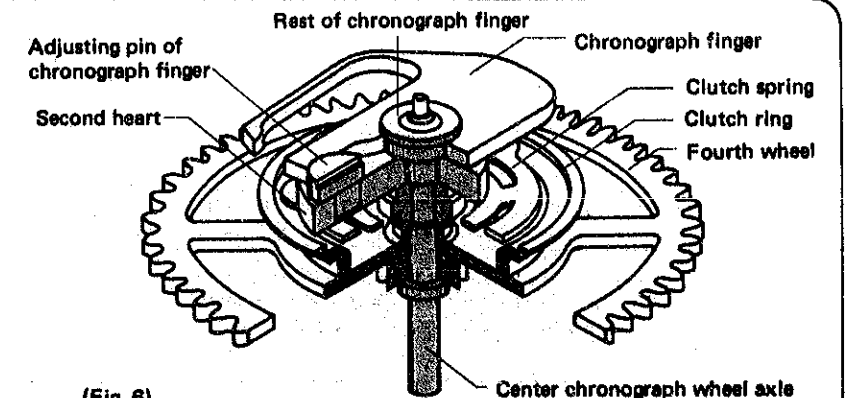

(Fig. 6)

## 6139A Operation of Chronograph Mechanism

### Starting

When depressing the first button, the pillar wheel is forwarded one tooth and the pillar wheel contacting portion of the first coupling lever falls between the columns, and the first and second coupling levers are separated from the clutch ring. The clutch ring is pressed to the fourth wheel by the clutch spring, and the second hand starts moving.

When the second hand makes a complete turn, the chronograph finger forwards the minute recording wheel one tooth through the intermediate minute recording wheel, operating the minute hand one graduation.

### Stopping

When depressing the first button in a started condition, the first and second coupling levers operate, raising the clutch ring. The clutch ring is separated from the fourth wheel, and the second hand comes to a halt. This time, the fourth wheel continues to rotate.

### Accumulation

When further depressing the first button in a stopped condition, the mechanism returns to a starting condition (Fig. 7), and the chronograph hands restart from its stopped position, the measured time being accumulated.

### Resetting

When depressing the second button in a stopped condition, the hammer is operated through the fly-back lever striking the second and minute hearts, and the hands are reset to the "0" position.

(When the hammer is on the column, i.e. the hands are in motion, the second button (fly-back button) cannot be depressed.)

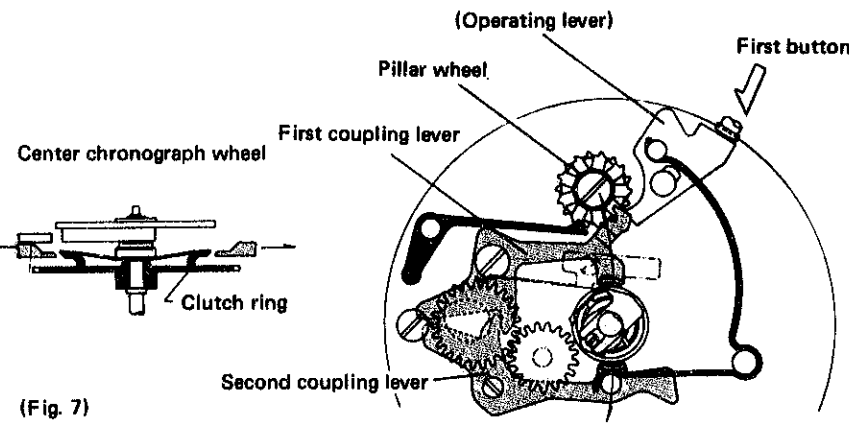

(Fig. 7)

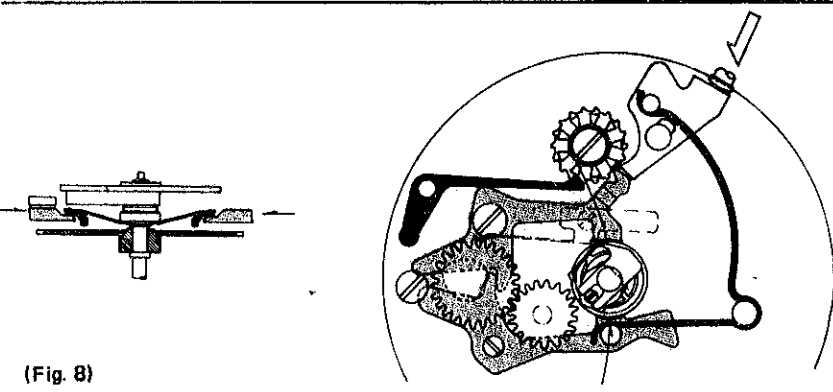

(Fig. 8)

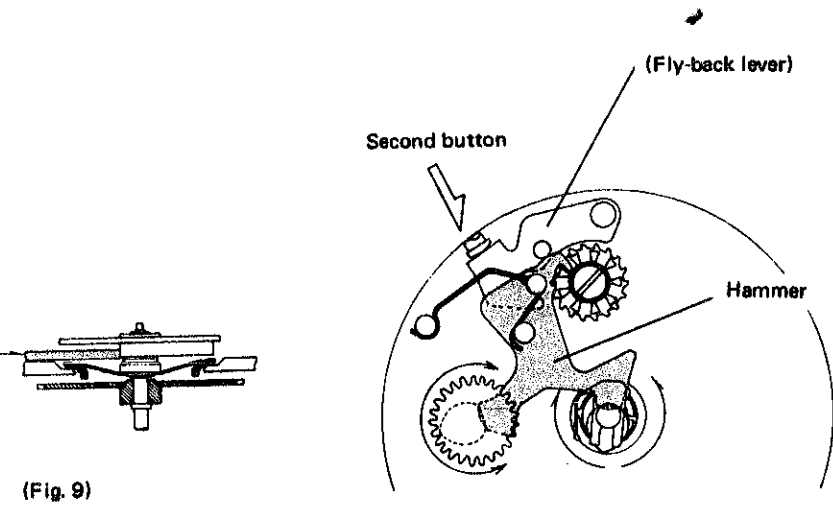

(Fig. 9)

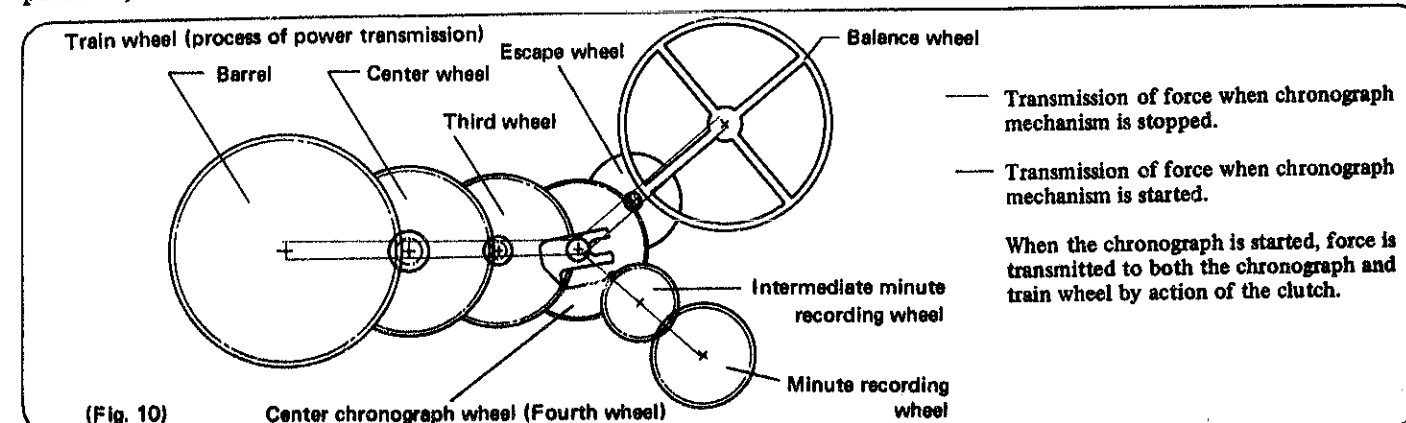

(Fig. 10)

## 6139A Train Wheel

To prevent chipping, install the pillar wheel on the barrel and train wheel bridge before assembling the latter.

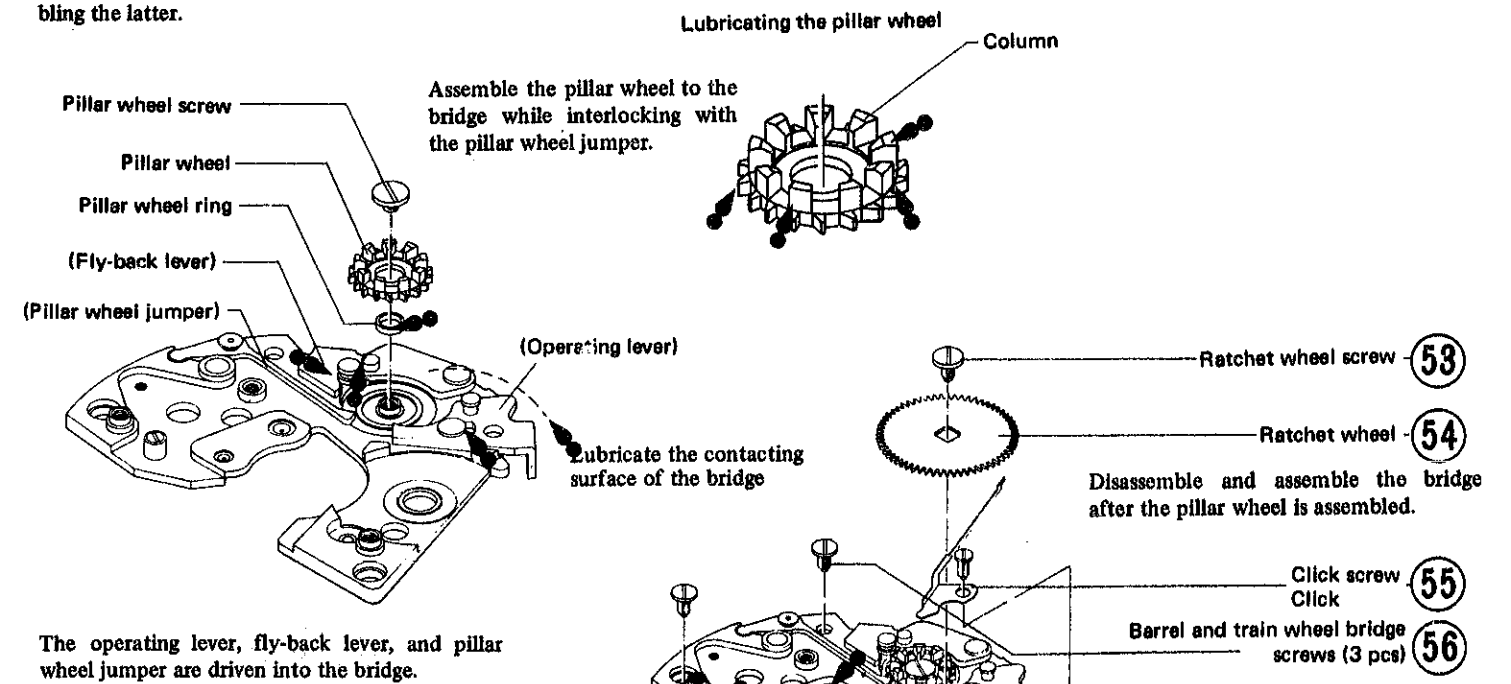

The operating lever, fly-back lever, and pillar wheel jumper are driven into the bridge.

Lubricating the fourth wheel and pinion:  
Set the center chronograph wheel on the staking tool as shown in the diagram; then lubricate the fourth wheel and pinion while depressing the wheel with a pair of tweezers.

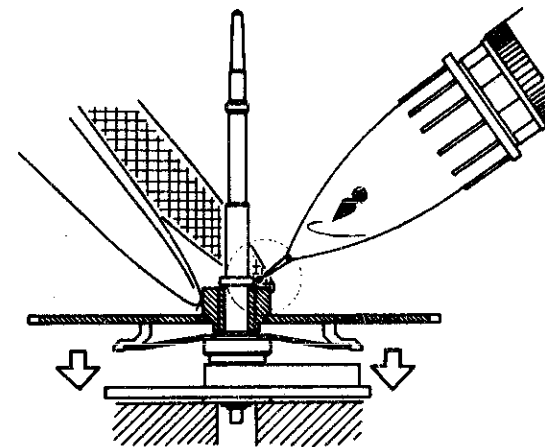

(Fig. 11)

## 6139A Setting Mechanism

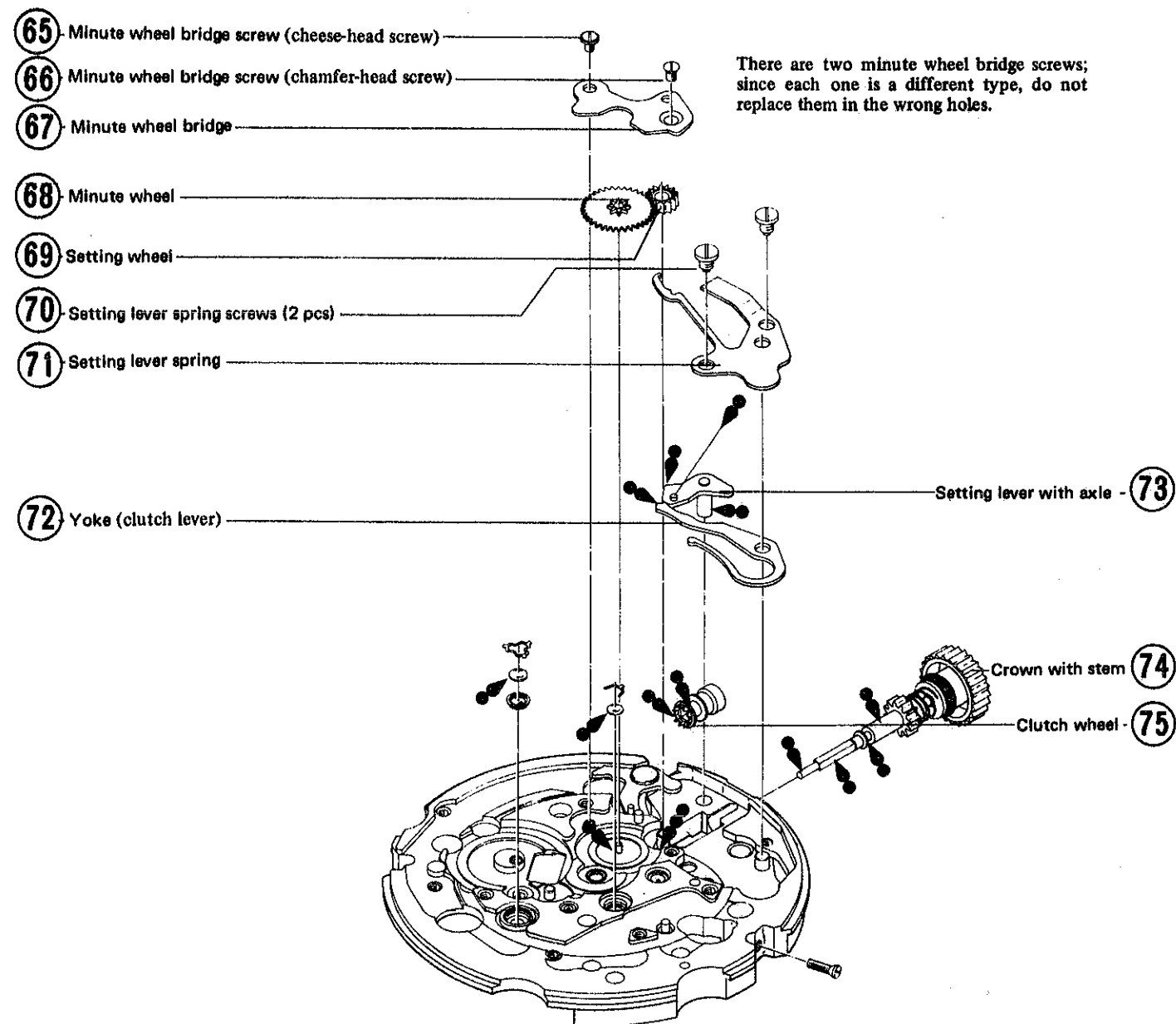

## 6139A Checking and Adjusting the Chronograph Mechanism-1

### I. Checking and adjusting the coupling levers

- When the up and down interlocking condition between the coupling levers and clutch ring is incorrect, it will cause various troubles such as damage to clutch spring (when interlocked deeper), halting, or free run (when interlocked shallower). Remedy by effecting the following procedures.

#### Checking:

- Confirm that the coupling lever's Point B comes to a lower level than the clutch ring's Point A when kept at "run" and the bridge side is turned up.
- Raise the fourth wheel and pinion while in a stopped condition, confirming that the clutch ring and fourth wheel are completely separated. (Fig. 13)

#### Adjusting:

Adjust vertical positioning of the upper and lower hole jewel of center chronograph wheel.

- Clearance of coupling levers and clutch ring.

#### Checking:

Clearance between clutch ring and first coupling lever and clearance between clutch ring and second coupling lever must be identical (Fig. 14).

#### Adjusting:

Adjust by turning the eccentric pin (\*) of the second coupling lever.

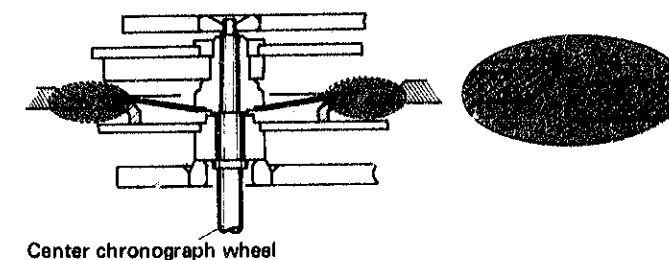

(Fig. 12)

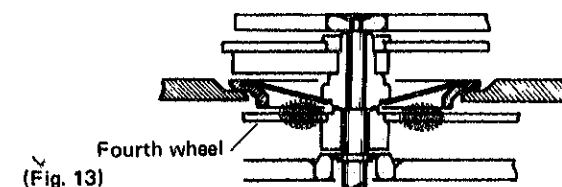

(Fig. 13)

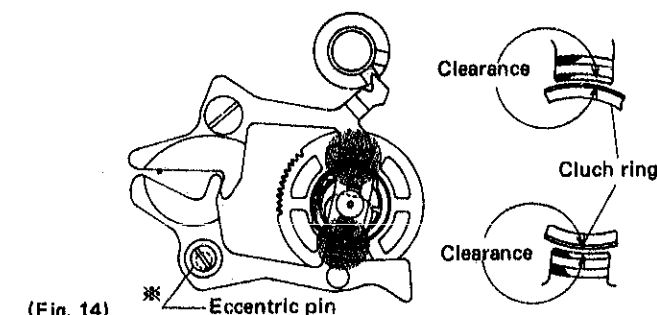

(Fig. 14)

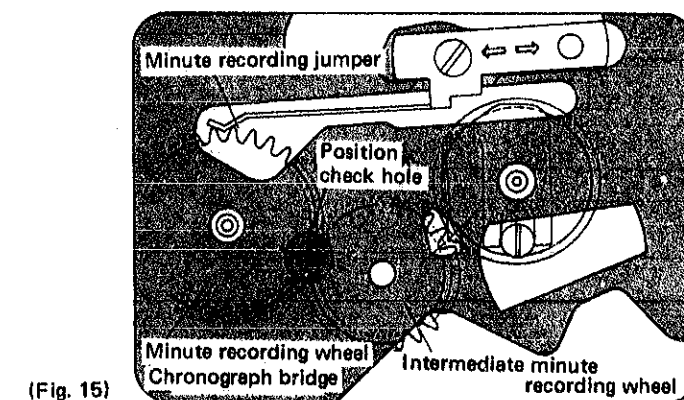

(Fig. 15)

### II. Checking and adjusting minute recording jumper

- Correct positioning of minute recording jumper  
Confirm that the three teeth of minute recording wheel can be observed symmetrically in the position check hole. (Fig. 15)

#### Adjusting:

Loosen the screw, and adjust the minute recording jumper by moving it to the right and left.

- Height of the minute recording jumper

#### Checking:

- Elevation of the minute recording jumper from the upper level of minute recording wheel must be less than half the thickness of the minute recording jumper. (Fig. 16)

(Fig. 16)

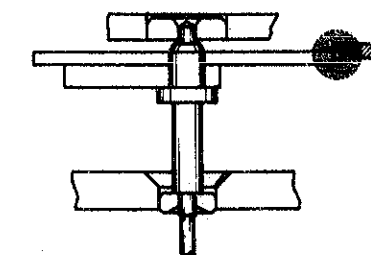

## 6139A Checking and Adjusting the Chronograph Mechanism-2

(2) By turning the minute recording wheel, confirm that the lower surface of the minute recording jumper does not contact top of the screw of first coupling lever. (Fig. 17)

Adjusting:

Bend the root of minute recording jumper either up or down. (Fig. 18)

### 3. Force of minute recording jumper

Insufficient force of minute recording jumper pressing against minute recording wheel results in retarding advance of the chronograph minute hand at forwarding time in minutes. If the force is too strong, it causes the chronograph minute hand to stop. Pay close attention to this.

Checking:

Check force of the minute recording jumper by strength of the mainspring.

(1) After completely releasing the mainspring, start it by winding the ratchet wheel just halfway, confirming that the chronograph finger adequately activates the minute recording wheel.

(2) Confirm that the minute recording jumper precisely regulates advance of the minute recording wheel. (Fig. 19)

Adjusting:

Bend the base of the minute recording jumper in either direction as indicated by arrows. (Fig. 20)

### III. Adjusting the chronograph finger

#### 1. Locking contact of chronograph finger

Checking:

After correctly adjusting the position of minute recording jumper (refer to Adjust II-1), rotate the chronograph finger forward in a stopped condition, checking the degree with which the chronograph finger contacts the intermediate minute recording wheel.

(1) The amount of such contact should be more than 1/4 but less than 1/2 the size of the flat end of the chronograph finger. (Fig. 21-A).

(2) The chronograph finger should not touch other teeth on both sides of the tooth contacting the intermediate chronograph wheel.

Adjusting:

First straighten out the chronograph finger spring (the oblique lined stem in Fig. 22); then bend the basic portion (encircled) to effect desirable contact.

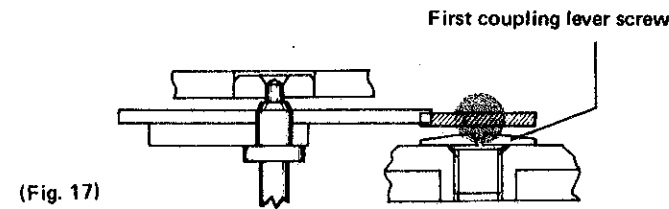

(Fig. 17)

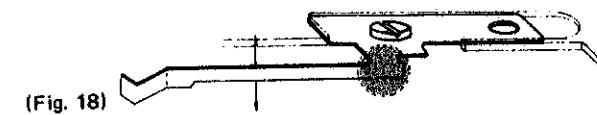

(Fig. 18)

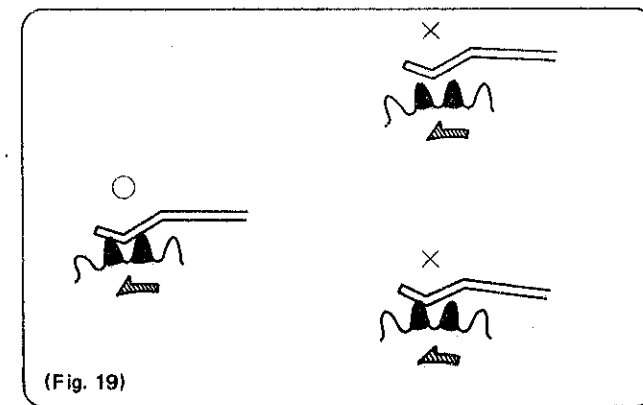

(Fig. 19)

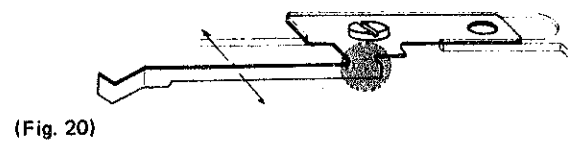

(Fig. 20)

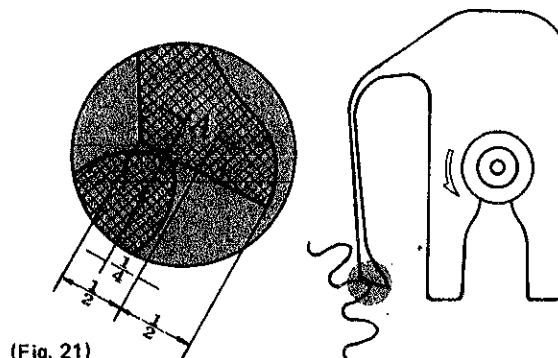

(Fig. 21)

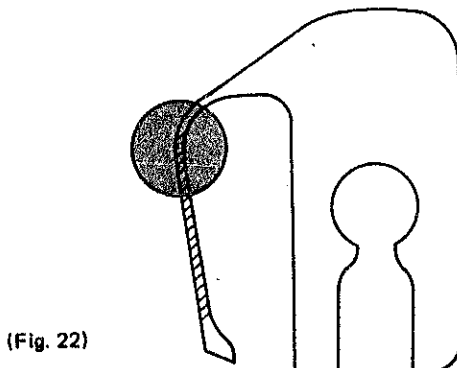

(Fig. 22)

## 6139A Checking and Adjusting the Chronograph Mechanism-3

### 2. Position of the chronograph finger

If the position of the chronograph finger rotating direction is abnormal, forwarding time of the chronograph minute hand becomes defective around the "0" second.

Checking:

After resetting the hands, point C of the chronograph finger must be straight on line between points A and B of the position setting hole. (Fig. 23)

Adjusting:

While keeping the hammer depressed, turn the adjusting pin of chronograph finger attached to the second heart, until the correct position for point C is obtained.

(Note) Be careful to avoid breaking the pivot of center chronograph wheel which sometimes occurs if the pin is pressed too strongly.

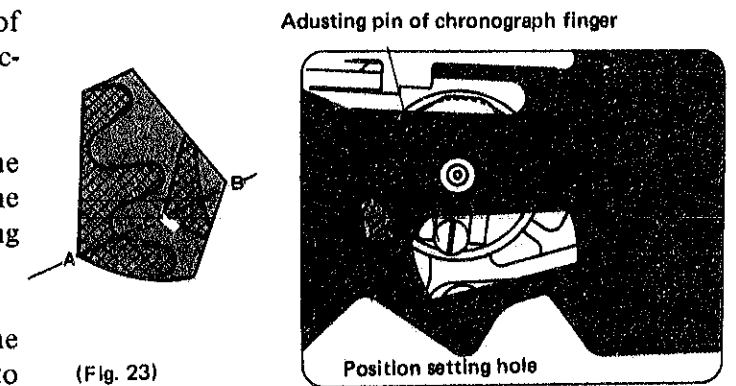

(Fig. 23)

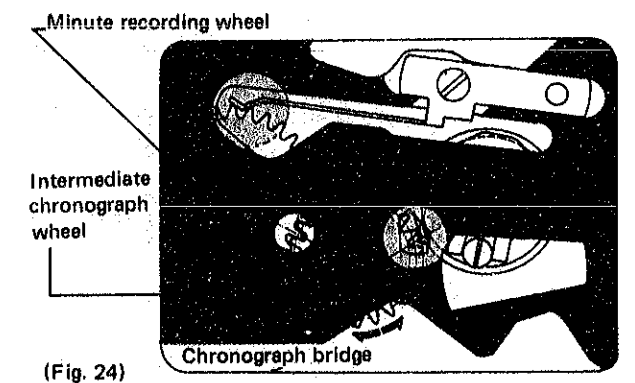

(Fig. 24)

### IV. Checking and adjusting contacting condition of the hammer and hearts

When the hands are reset, there should be no clearance between the setting surface of the hammer and the second heart. Suitable clearance between setting surface of the hammer and the minute heart is 0.02mm. Should the clearance be excessive, the hands will not be reset to the "0" second.

Checking:

Actually, it is difficult to observe clearances between the hearts and the hammer, so clearances should be judged by the degree of shake observed when the intermediate minute recording wheel, minute recording wheel, and center chronograph wheel are reset to their original position. (Fig. 24)

- Adjust clearance between the second heart and the hammer to zero. In a condition that the hammer is depressed (i.e. in a condition that the hearts and the hammer are contacted), no shakes should occur when slightly moving the center chronograph wheel to the right and left.
- Check clearance of the minute heart by rotating the minute recording wheel to the right and left. (Table 1)

A. Keep the hammer continuously depressed. Teeth of the intermediate minute recording wheel should not pass over the crest of the chronograph finger.

B. Similarly, teeth of the minute recording wheel should not pass over the crest of the minute recording jumper.

	Intermediate minute recording wheel: A		Minute recording wheel: B	
Free condition				
When turning A to the right				
When turning A to the left				
Adjustment	—	Polish second setting surface of the hammer	—	Polish second setting surface of the hammer

Table 1

## 6139A Checking and Adjusting the Chronograph Mechanism-4

Adjusting:

When shakes exist in the second heart:

Polish setting surface of the hammer contacting the minute heart.

When shake of the minute heart is excessive (when passing over the crest):

Polish setting surface of the hammer contacting the second heart.

(Note) When polishing the hammer, slightly file the point parallel to the setting surface, finishing to a mirrored surface. (Fig. 25)

### V. Adjusting pressing strength of the second button (fly-back button)

After installing the movement and the buttons on the case, check pressing strength of the second button.

Adjust pressing strength to the same as that of the first button. When the pressing strength is too strong, it will damage the chronograph mechanism.

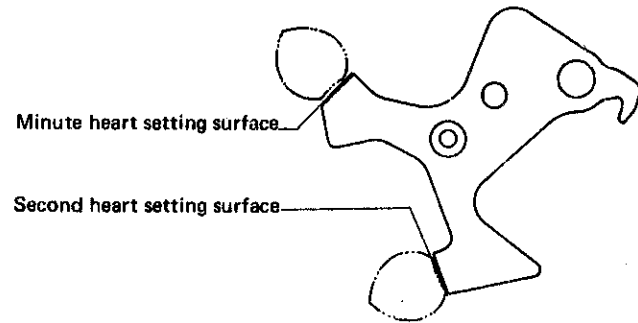

(Fig. 25)

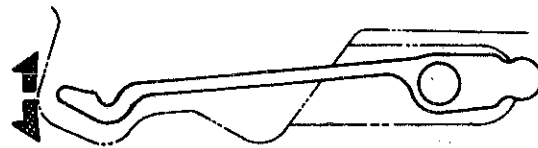

(Fig. 26)

Adjusting:  
Bend tip of the hammer click by holding the pit portion. Do this carefully; the parts are apt to be damaged when it is bent too much.

## Repairing the Chronograph Mechanism

### I. Repairing Method

#### 1. Center chronograph wheel—Damage due to:

- (1) Broken clutch spring
- (2) Strength of clutch spring too weak
- ✓ In these cases, the chronograph second hand either fails to move or moves irregularly.
- (3) Broken chronograph finger

Broken chronograph finger does not advance the chronograph minute hand.

If (1), (2) or (3) occur, replace the center chronograph wheel, referring to Checking and Adjusting the Coupling Levers mentioned in item I, Adjusting the Chronograph Finger mentioned in III, and Checking and Adjusting the Contacting Condition of the Hammer and the Hearts mentioned in IV of Chronograph Adjustment.

#### 2. Loose chronograph second hand

If the chronograph second wheel does not reset to the "0" position when depressing the button, confirm the following point.

Check if the second hand moves when the second button is pressed. If it moves, the cause is due to loose contact of the second hand and center chronograph wheel axle. To correct this, reinsert the second hand to the extent that does not cause second hand catching.

#### 3. Poor revolving efficiency of the fourth wheel

If the gear-train is not functioning well in a stopped condition, repair the watch after confirming the following points:

- (1) Check for correct shakes
- (2) Check for friction between each wheel
- (3) Check for correct revolving condition of the fourth wheel

As to confirming item (3), first install the chronograph bridge in a condition that the coupling levers are secured to the barrel and train wheel bridge. Next, as shown in Fig. 27, set the fourth wheel in a starting condition with the bosom side of the barrel and train wheel bridge built in the chronograph bridge upward. Next, after confirming clearance between the fourth wheel and clutch ring in a stopped condition, turn the fourth wheel and pinion with a soft brush to check whether or not it turns smoothly. If revolution is defective, clean and lubricate it (refer to Fig. 11) and reconfirm operation.

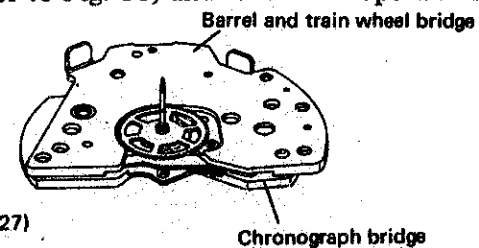

(Fig. 27)

# 6139A After-Sales Service-Trouble-Shooting

The chronograph mechanism is very precisely constructed. When repair is requested, it is important to listen to the customer describe the watch condition. Further, it proves especially valuable in ensuring correct repair to classify the

cause according to the following table, based on details described by the customer. Listing malfunctions in the chronograph mechanism, their causes, and corrective actions, this table can be used effectively.

Mechanisms	Phenomena	Causes	Corrective action	
Starting stopping mechanism	First and/or second buttons do not move	Button gasket worn out Dust adhered around button axle Lack of silicon grease		
	Mechanism does not start even when depressing button	Deeper than necessary interlocking of chronograph finger . . . . . Refer to Chronograph Adjusting III-1 Damaged center chronograph wheel . . . . . Refer to Chronograph Repairing I Unsmooth operation of first and second coupling levers Hands catching		
	Defective forwarding time of chronograph minute hand	Defective position of minute forwarding . . . . . Refer to Chronograph Adjusting III-2 Loosened chronograph second hand . . . . . Refer to Chronograph Repairing I		
	Chronograph minute hand only moves in middle of graduation	Shallow interlocking of chronograph finger . . . . . Refer to Chronograph Adjusting III-1 Weak minute recording jumper . . . . . Refer to Chronograph Adjusting II-3 Detached minute recording jumper . . . . . Refer to Chronograph Adjusting II-2 Malfunction of intermediate minute recording wheel turning Chronograph minute hand catching		
	Chronograph minute hand stops in forwarding condition	Deep interlocking of chronograph fingers . . . . . Refer to Chronograph Adjusting III-1 Strong minute recording jumper . . . . . Refer to Chronograph Adjusting II-3 Detached minute recording jumper . . . . . Refer to Chronograph Adjusting II-2 Insufficient amplitude Malfunction of intermediate minute recording wheel turning		
	Chronograph minute hand not being forwarded	Damaged center chronograph wheel . . . . . Refer to Chronograph Repairing I Shallow interlocking of chronograph wheel . . . . . Refer to Chronograph Adjusting III-1		
	Chronograph minute hand forwarded simultaneously with starting	Defective chronograph finger position . . . . . Refer to Chronograph Adjusting III-2		
	Hands do not stop even when depressing first button to stop position	Damaged center chronograph wheel . . . . . Refer to Chronograph Repairing I Clutch spring raises only slightly . . . . . Refer to Chronograph Adjusting I-1		
	Resetting mechanism	Defective pressing condition of buttons	Abrased button gasket Lack of silicon grease Weak hammer click . . . . . Refer to Chronograph Adjusting V Lack of oil on fly-back lever pin	
		Second hand does not reset to the "0" position	Deep interlocking of chronograph finger . . . . . Refer to Chronograph Adjusting III-1 Loosened chronograph second hand . . . . . Refer to Chronograph Repairing I Abrased hammer . . . . . Refer to Chronograph Adjusting IV	
Chronograph minute hand does not reset to the "0" position		Deep interlocking of chronograph finger . . . . . Refer to Chronograph Adjusting III-1 Weak minute recording jumper . . . . . Refer to Chronograph Adjusting II-3 Detached minute recording jumper . . . . . Refer to Chronograph Adjusting II-2 Excessive shakes of minute heart and hammer . . . . . Refer to Chronograph Adjusting VI		
Hands do not reset even when depressing the second button		Damaged fly-back lever pin		
Defective durability	No durability in starting condition	Deep interlocking of chronograph finger . . . . . Refer to Chronograph Adjusting III-1 Damaged center chronograph wheel . . . . . Refer to Chronograph Repairing I Strong minute recording jumper . . . . . Refer to Chronograph Adjusting II-3 Insufficient amplitude		
	No durability in stopping condition	Friction of fourth wheel Defective rotating condition of fourth wheel . . . . . Refer to Chronograph Repairing I Insufficient amplitude		

## 6139A CHECKING ON WATCH STOPPING, AND REPAIRING AND ADJUSTING PROCEDURES

---

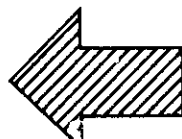

Regarding repairing and adjusting of Cal. 6139A, we have already mentioned them in the SEIKO TECHNICAL GUIDE. However, on these pages, items to be checked on watch stopping, and repairing and adjusting for each item, are compactly arranged to facilitate further comprehension.

### EXPLANATIONS REGARDING WATCH STOPPING AT 58 SECOND POSITION

○ **A watch stopping at 58 second position is not malfunctional.**

When the mainspring winding is insufficient the second hand always stops at the 58 second position.

But this is not a malfunction.

○ **The reason why a watch stops at 58 second position:**

In the 6139A, when the second hand moves from 58 to 60 second, the mechanism is devised so that the chronograph minute hand moves one graduation. At the 58 second position where the chronograph minute hand moves, a larger mainspring force is required.

Consequently, when the mainspring is nearly unwound, 6139A always stops at the 58 second position.

○ **A watch in the following condition' is defective.**

When the second hand stops at the 58 second position in spite of a fully wound mainspring, the watch is defective. Repair and adjust it according to the following procedures.

**1. Items to be checked before beginning repair works.**

\*Checking the number of remaining windings of the mainspring

**2. When the balance stops at the 58 second position.**

**3. When the second hand stops at the 58 second position and the balance is still moving.**

# 6139A CHECKING ON WATCH STOPPING, AND REPAIRING AND ADJUSTING PROCEDURES

(Example of stopping at 58 second position)

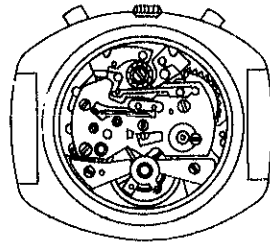
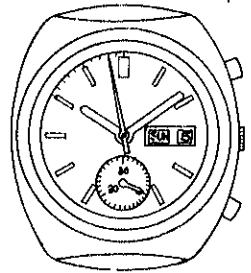

Enlarged diagram

## 1 Confirm the Following Items Before Beginning Repair Work

- Check the number of remaining windings of the mainspring of the watch, of which the second hand stops at the 58 second position as shown in the above diagram.
- In this case, when the number of remaining windings of the mainspring is.....  
 More than 1 - 1.5 windings..... Adopt Procedure 2  
 Under 1 winding..... Adopt Procedure 3

### \*Checking the number of remaining windings of the mainspring

- Remove the automatic winding section (oscillating weight section).
- Firmly hold the ratchet wheel screw with a driver and release the click by using a pair of tweezers.
- In this condition, gradually turn the ratchet wheel screw counterclockwise until the mainspring power is exhausted (releasing the mainspring).
- This revolving number of the ratchet wheel screw corresponds with the number of remaining windings of the mainspring.

(Note)

It is convenient to count the number of remaining windings of the mainspring by confirming the direction of the groove of the ratchet wheel screw.

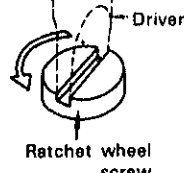

[When the number of remaining windings of the mainspring exceeds 1 - 1.5 windings]

## 2 When the Balance stops at the 58 second Position

In this case, inspect the watch according to CHECKING PROCEDURES 4 through 6 after removing the case back and the automatic winding section (oscillating weight section).

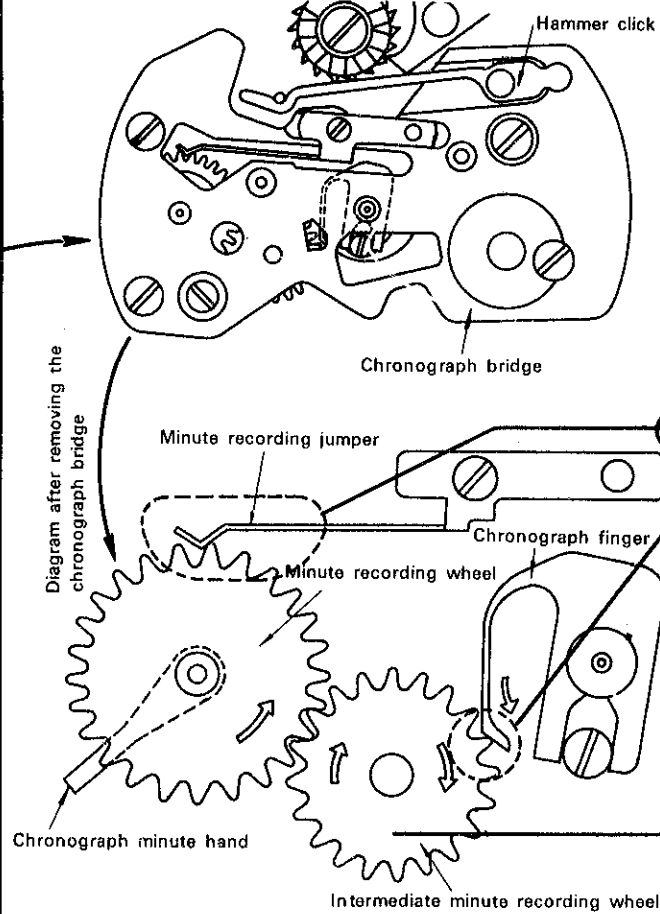

[When the number of remaining windings of the mainspring is under 1 winding]

## 3 When the Second Hand stops at the 58 second Position and the Balance is Still Moving

In this case, inspect the watch according to CHECKING PROCEDURE 7.

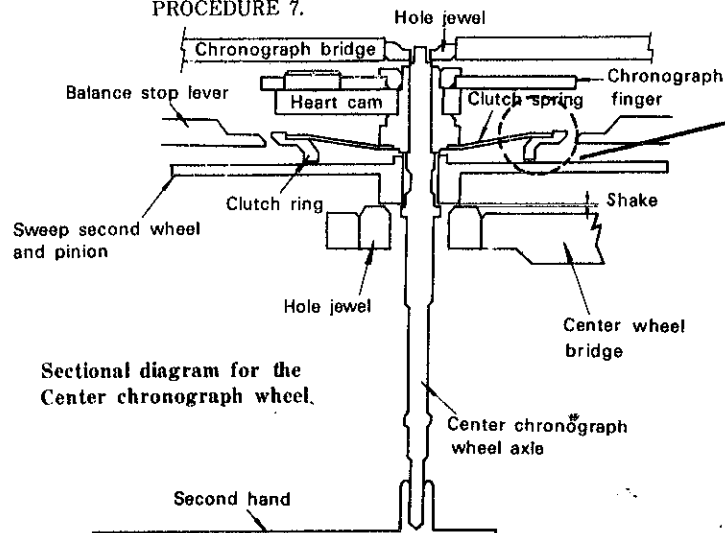

Checking procedure	Checking details	Repairing and checking methods									
4	<p>Check the condition when the chronograph finger contacts the intermediate minute recording wheel (when the minute forwarding is ready to start).</p>	<p>In case of X, Adjust the amount which the chronograph finger contacts with the wheel by bending this portion in the → or ← direction, holding it with a pair of tweezers.</p> <p>The amount of such contact (L) should be more than 1/4 but less than 1/2 the size of L.</p>									
5	<p>Check whether or not teeth of the minute recording wheel are forwarded by winding the ratchet wheel only half a revolution after completely releasing the mainspring.</p> <table border="1"> <thead> <tr> <th>At 58 - 59 second</th> <th>At 60 second</th> <th>Judgment</th> </tr> </thead> <tbody> <tr> <td></td> <td></td> <td>○</td> </tr> <tr> <td></td> <td>(Stopping)</td> <td>×</td> </tr> </tbody> </table> <p>Cannot be forwarded because the spring of the minute recording jumper is too strong</p>	At 58 - 59 second	At 60 second	Judgment			○		(Stopping)	×	<p>In case of X, create a forwarding condition by winding the ratchet wheel only half a revolution after completely releasing the mainspring. To satisfy both following ① and ②, adjust strength of the minute recording jumper spring.</p> <ol style="list-style-type: none"> <li>Minute forwarding is correctly performed between 58 and 60 second position.</li> <li>After performing minute forwarding, chronograph finger always must be geared correctly into the wheel.</li> </ol> <p>Adjust strength of the minute recording jumper spring by bending this portion in the ↑ or ↓ direction.</p> <p>Minute recording wheel</p> <p>(Note) When the minute is not forwarded in spite of weakening the strength of minute recording jumper, first check and correct the watch according to Procedure 6; then adjust strength of the minute recording jumper.</p>
At 58 - 59 second	At 60 second	Judgment									
		○									
	(Stopping)	×									
6	<p>Remove the chronograph bridge and check on revolving condition of the intermediate minute recording wheel.</p> <p>Lightly turn the intermediate minute recording wheel with a soft small brush.</p> <p>Turns lightly ..... ○ Turns heavily ..... ×</p>	<p>When the intermediate minute recording wheel turns heavily (×), wash the chronograph bridge with an ultrasonic cleaner.</p> <p>(Note) Never lubricate the intermediate minute recording wheel.</p>									
7	<p>[When the second hand stops at the 58 second position and the balance is still moving, the cause is due to slipping of the clutch ring.]</p> <p>(Note) If the shake of the center chronograph wheel is excessive, the second hand moves intermittently in spite of stopping condition. Adjust the shake properly (the shake is proper when it is almost the same as ordinary wheel's).</p>	<p>Remove the center chronograph wheel and sufficiently wash it; then lubricate between the fourth wheel and the center chronograph wheel axle with Moebius Synt-A-Lube. Confirm the moving condition of the clutch. When the clutch is loosened, replace the center chronograph wheel with a new one. In this case, properly adjust shake of the new center chronograph wheel.</p> <p>Adjust the shake by raising or lowering this hole jewel. (Adjust it on a staking tool or a riveting-stake).</p>									

### General Checking Procedures After Repairing

#### 1. Pushing strength of the hammer button

When pushing strength of the hammer button is too heavy, the second hand is reset too fast, causing a defective resetting position. consequently adjust it lightly as far as possible.

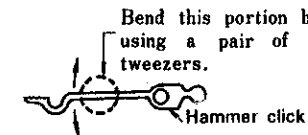

[When adding weight..... ↑ direction]  
[When reducing weight... ↓ direction]

#### 2. Clearance between hands

When the clearance between the second hand and the minute hand is too narrow, sometimes the second hand scratches the minute hand when resetting. Always check the clearance between the hands.

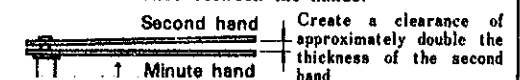

(Note) When installing the second hand, use the movement holder (S-500) for 6139A.



## Checking, Repairing and Adjusting Methods for Slipping of Chronograph Second Hand at the Fly-Back Position of Cal. 6138A and 6139A

---

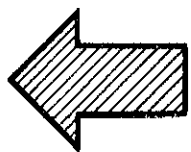

Checking, repairing, and adjusting methods of watch stopping at 58 second position of Cal. 6139 have been explained in detail in 6139A-14. On these pages, only slipping of chronograph second hand at the fly-back position is described.

When you are requested to repair slipping of the fly-back position, please refer to the following procedures.

Explanations in these pages can be utilized in common to both 6138A and 6139A.

- **Check Points Before Starting Repair**
  
- **When Chronograph Second Hand does not Return to "0" Position**
  
- **When Both Chronograph Second Hand and Minute Hand do not Correctly Return**
  
- **Overall Check Points after Repair**

# Checking, Repairing and Adjusting Methods for Slipping of Chronograph Second Hand at the Fly-Back Position of Cal. 6138A and 6139A

If the chronograph second hand does not return to the "0" position when pushing the fly-back button (2nd button), confirm that the condition is Case 1 or Case 2, before repairing.

## 1 When the Chronograph Second Hand Does Not Return to "0" Position

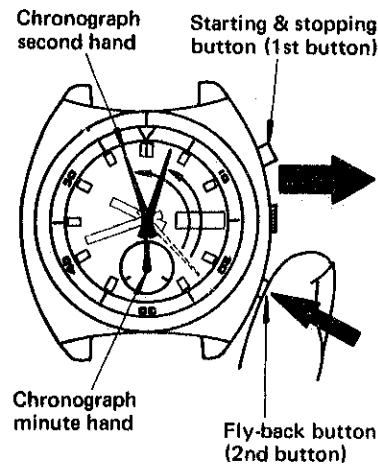

## 2 When both Chronograph Second Hand and Minute Hand Do Not Correctly Return

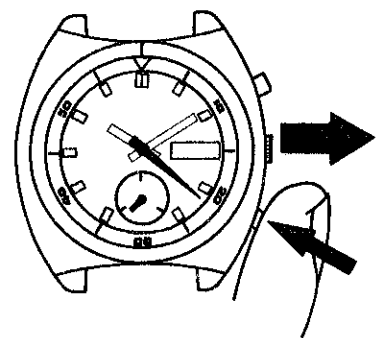

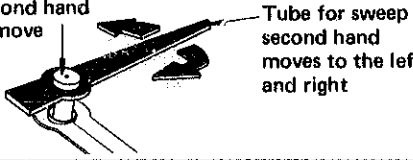
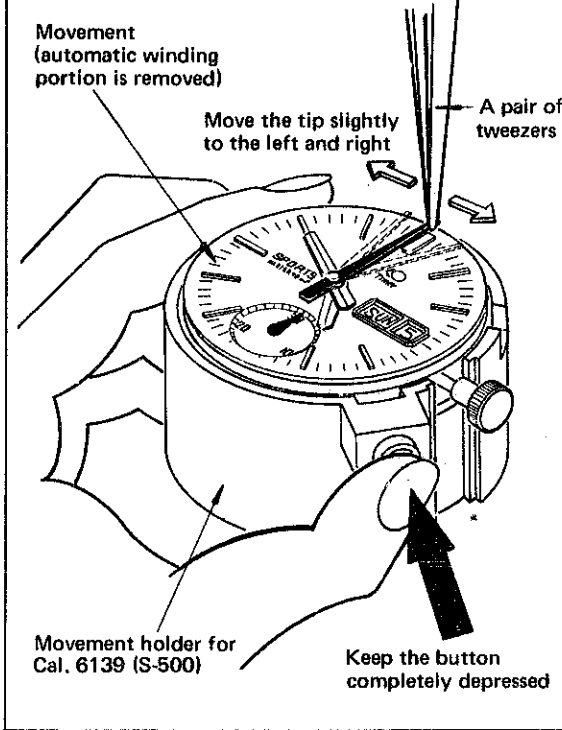
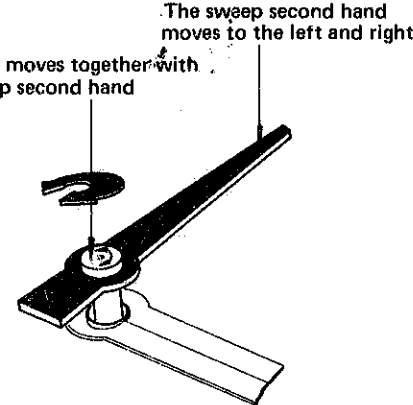
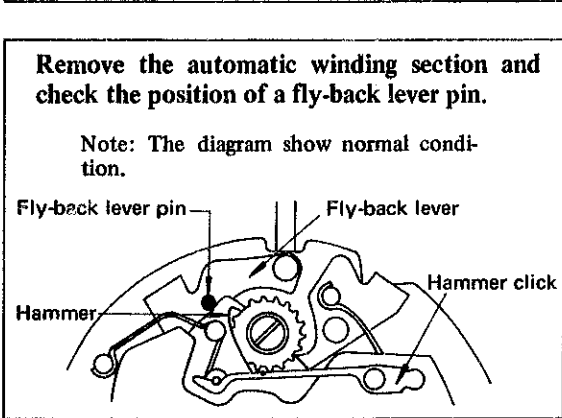
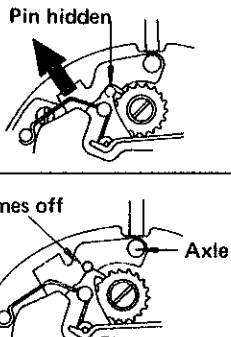
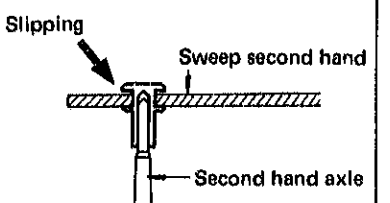
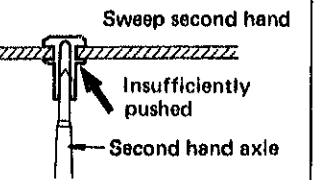
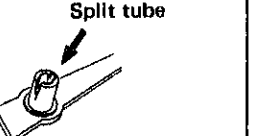
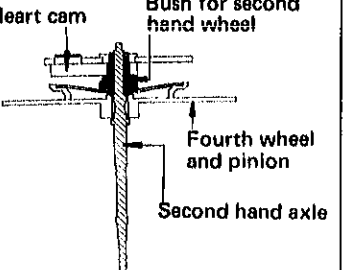
Check Poits	Repairing and Adjusting Methods
<p>Hold the tip of the chronograph second hand with a pair of tweezers and move it slightly to the left and right while keeping the fly-back button completely depressed.</p>	<p>1. When only the sweep second hand moves while the tube for sweep second hand does not move.</p> <p>Sweep second hand does not move</p> <p>Tube for sweep second hand moves to the left and right</p> 
<p>Movement (automatic winding portion is removed)</p> <p>Move the tip slightly to the left and right</p> <p>A pair of tweezers</p> <p>Movement holder for Cal. 6139 (S-500)</p> <p>Keep the button completely depressed</p> 	<p>2. When the sweep second hand and the tube for sweep second hand move together</p> <p>The sweep second hand moves to the left and right</p> <p>The tube moves together with the sweep second hand</p> 
<p>Remove the automatic winding section and check the position of a fly-back lever pin.</p> <p>Note: The diagram show normal condition.</p> <p>Fly-back lever pin</p> <p>Fly-back lever</p> <p>Hammer</p> <p>Hammer click</p> 	<p>1. When the fly-back lever pin is hidden under the hammer</p> <p>Pin hidden</p> <p>2. When the fly-back lever pin comes off</p> <p>Pin comes off</p> <p>Axle</p> 
<p>This is caused by a slip between the sweep second hand and the tube for sweep second hand as shown in the diagram on the right.</p> <p>In this case, replace it with a new chronograph second hand.</p> <p>Slipping</p> <p>Sweep second hand</p> <p>Second hand axle</p> 	<p>*(a) Insufficient installation of the second hand may cause this malfunction. First, completely push the second hand, and then recheck the fly-back position of second hand.</p> <p>If this method is not effective, make a check (b).</p> <p>Sweep second hand</p> <p>Insufficiently pushed</p> <p>Second hand axle</p> 
<p>(b) Detach the second hand and check the tube for sweep second hand</p> <p>* If the tube hole is enlarged too much or split as shown in the diagram on the right, replace it with a new sweep second hand.</p> <p>Split tube</p> 	<p>(c) If the above-mentioned methods (a) and (b) are not effective, it may be caused by a slip between the bush for second hand wheel of the center chronograph wheel (in red color) and the second hand axle (oblique lines portion). In this case, replace it with a new center chronograph wheel. At the same time, adjust the chronograph finger.</p> <p>Note: For details, refer to 6139A-9</p> <p>Heart cam</p> <p>Bush for second hand wheel</p> <p>Fourth wheel and pinion</p> <p>Second hand axle</p> 

### Overall Check Points After Repair

1. Pushing strength of the hammer button  
Recommended pushing strength of the fly-back button is the same as that of the starting and stopping button. If the strength is too heavy, the second hand is returned so quickly that the fly-back position may slip.

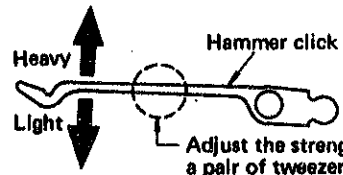

2. Clearance between second hand and minute hand  
Create clearance double the thickness of the second hand between the second hand and the minute hand. After completely pushing in the second hand, adjust the clearance by bending the second hand upward.

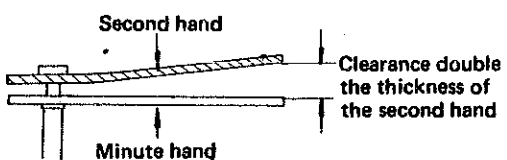

### (Reference) Installation Method of Chronograph Second, Minute, and Hour Hands

- After removing the automatic winding section, set the movement on the movement holder (S-500) for Cal. 6139.
- After setting the second hand (or chronograph minute and hour hands) at the "0" position, push it in lightly while keeping the fly-back button completely depressed. (Fig. 1)
- After confirming the fly-back position of the second hand, completely push in the second hand.

Note: Since the tip of the center chronograph wheel is shaped as shown in Fig.2, the second hand will be loosened when it is moved to the right and left after completely setting it.

Fig. 2

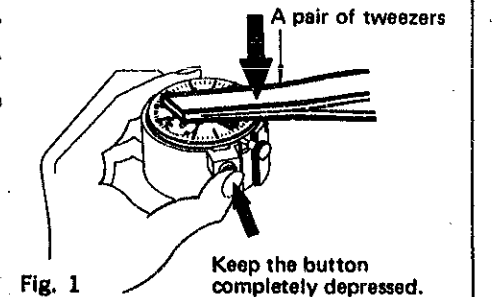

Fig. 1