

TECHNICAL INFORMATION

CITIZEN QUARTZ

Cal. No. C810

Contents

§1. OUTLINE	1
§2. SPECIFICATIONS	1
§3. NAME OF PARTS	2
§4. EL LIGHT	2
§5. SETTING THE ANALOG TIME	3
§6. SWITCHING DIGITAL FUNCTIONS (MODES)	3
§7. USING DIGITAL FUNCTIONS (MODES)	4
A. Time Mode	4
B. Calendar Mode	5
C. Alarm Mode.....	6
D. Chronograph Mode	7
E. Timer Mode.....	8
§8. ALL RESET FUNCTION	9
§9. DISASSEMBLY AND ASSEMBLY OF MOVEMENT	10
§10. TROUBLE SHOOTING AND ADJUSTMENT	12

§1. OUTLINE

This is a combination quartz watch with a full range of features such as Time, Calendar, Alarm, Chronograph, and Timer, plus the taplight function, which illuminates the face when you tap the watch face gently.

§2. SPECIFICATION

Caliber No.		C810	
Type		Combination quartz watch	
Movement size (mm)		ø30.8 x 6.41t	
Time accuracy (At normal temperature)		Within ±20 sec/month (+5°C ~ +35°C / 41°F ~ 95°F)	
IC		1 unit of C/MOS-LSI	
Operating temperature		0°C ~ +55°C (32°F ~ 131°F)	
Converter		Bipolar step motor	
Time adjustment		No adjustment terminal for in the market	
Measurement gate		10 sec.	
Display function	Analog time		
	Hour, Minute, Second		
	Digital	Time	Hours, Minutes, Seconds (Normal time/switch to summertime (daylight saving time))
		Calendar	Month, Date, Day, (Year)
		Alarm	Hours, Minutes, ON/OFF, Alarm Monitor
		Chronograph	24-hour measurement (in 1/100 second units), Split Time Measurement
Timer		60-minute countdown (in 1 minute increments)	
Additional function		Tap light EL light	
Battery	Parts No. / Code	280-74/SR936W	
	Life time	About 2 years. (Based on assumed use of alarm buzzer 20 seconds/day, timer buzzer 5 seconds/week and EL Light 3 seconds/day.	

* These specifications are subject to change, for product improvement, without prior notice.

§3. NAME OF PARTS

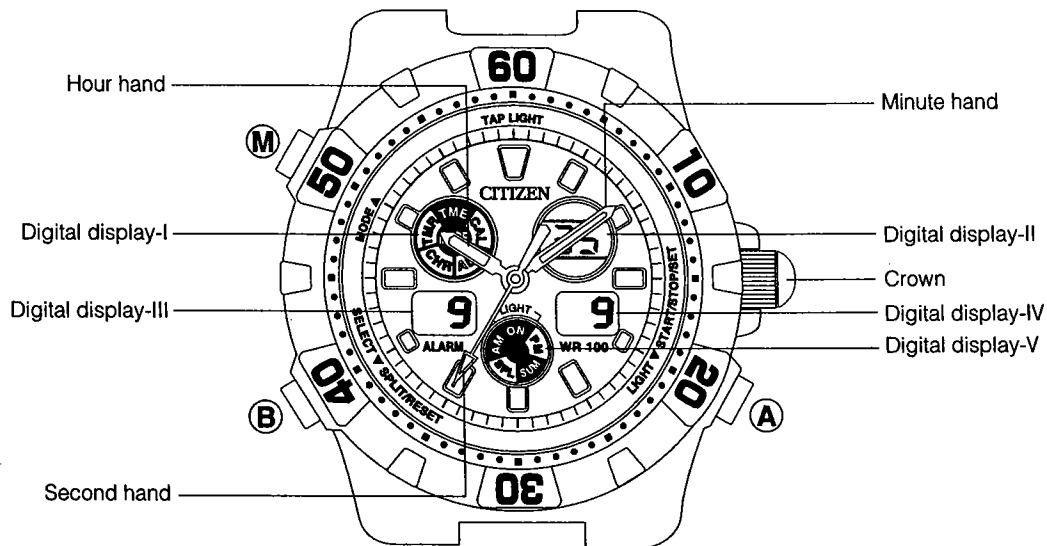

§4. EL LIGHT

It is called electro-luminescence. It is a scientific phenomenon in which the display panel becomes illuminated when voltage is applied to it.

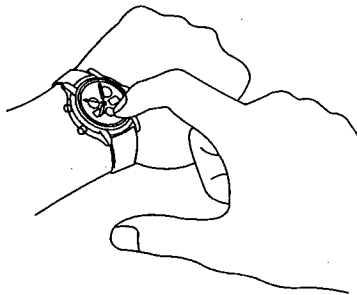

[How to Light the Illumination]

1. How to switch the EL light on by the taplight switch (just by tapping the watch face)
 - When the taplight switch is "ON", and you tap the glass face of the watch lightly with your fingernail etc., the EL light will be illuminated for 2 seconds.
 - ☆ Do not tap on the glass face with any sharp or metallic object as these could scratch or break the glass.
 - ☆ If the watch is strapped tightly to your wrist, it may become difficult to switch the taplight on. For best results, adjust the strap to deep some slack.

How to Turn the Taplight Switch "ON and OFF"

- (1) When the normal time or calendar mode is displayed, press the button **M** for about 2 seconds. The taplight switch will now toggle the taplight switch between "ON" and "OFF" each time you tap the crystal.
 - When you press the button **M**, the display will switch first to the next mode (e.g. from time mode to calendar mode), and return automatically to the previous mode.
 - When the taplight switch is "ON", the "ON" in Digital Display V will flash. As the taplight switch is switched on, the confirmation tone will sound and the EL light will flash for 2 seconds.
 - When you switch the taplight switch "OFF", the confirmation tone will sound, but the EL light will not flash.
 - ☆ When you do not use the EL light, you should deactivate the taplight switch to prevent needless battery use.

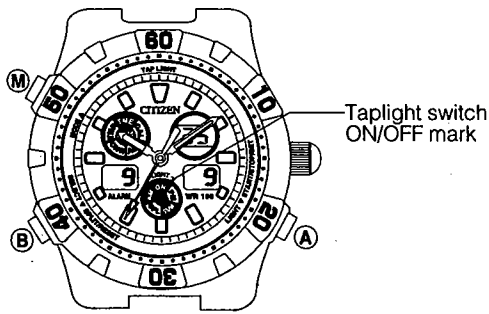

2. How to switch the EL light on by pressing button **(A)**.
 - Regardless of whether the taplight switch is "ON" or "OFF", when you press the button **(A)** while the watch is in normal time or calendar mode, the EL light flashes for 2 seconds.

§5. SETTING THE ANALOG TIME

You may also set the analog and digital displays for different times as a dual time display.

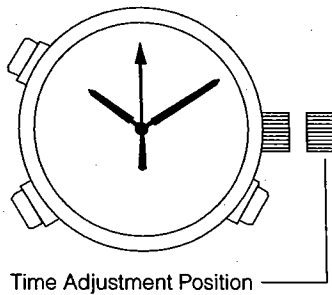

- (1) Pull the crown out and stop the second hand.
- (2) Turn the crown and set the hands to the correct time.
- (3) After setting the time, press the crown back in to start the watch.

☆ Stop the second hand at the "0" position and then press the crown when the digital display reaches zero seconds. The second hand will start moving in synchronization with the digital display.

§6. SWITCHING DIGITAL FUNCTIONS (MODES)

In addition to Time mode, this watch has 4 other modes; Calendar, Alarm, Chronograph and Timer.

Press button **(M)** to switch to desired mode. Mode mark in Digital display-I indicates the mode in which the watch is presently set.

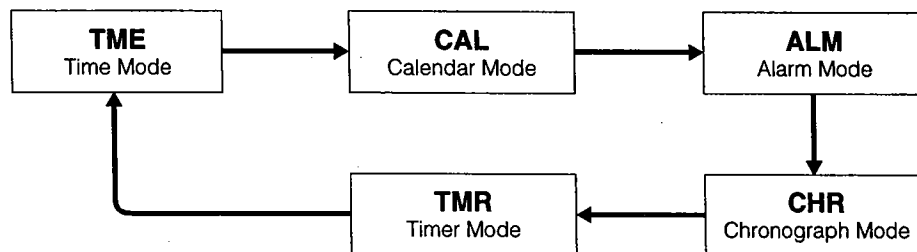

Auto-Return

- When the watch is left in normal Alarm mode for more than 2 minutes without any button operation, the display will automatically return to Time mode.

§7. USING DIGITAL FUNCTIONS (MODES)

A. TIME MODE

- You can easily reset the watch to summertime (Daylight Saving Time) using the time adjustment mode.
- Press the button **(A)** while the watch is in normal Time display to switch the EL light on.

<To Set to Summer time (Daylight Saving Time)>

- (1) Press and hold button **(B)** for 2 seconds or longer in Time mode (normal display). "SUM., ON or SUM., OF" will flash and become an adjustment position for summertime.
- (2) Press button **(A)** while "SUM., ON or SUM., OF" is flashing. Each time button **(A)** is pressed, ON or OF will change.
 - When summertime is set, the watch shows the time one hour earlier than standard time.
- (3) Press button **(M)** to return to Time mode.

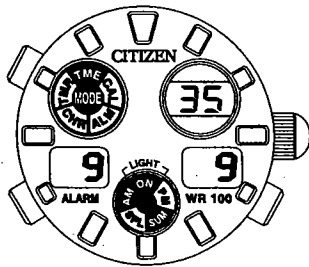

<To Adjust Hours and Minutes>

- (1) If you press button **(B)** during summertime adjustment (while "SUM" is flashing), the flashing section will change. Press button **(B)** until the part you want to adjust is flashing.
- (2) Press button **(A)** to adjust flashing section.
 - Press and hold button **(A)** for rapid advancement.
- (3) Press button **(A)** while seconds are flashing, seconds will return to "00" and restart.
 - If seconds show 30 through 59, minutes display will advance one minute.
- (4) Press button **(M)** to return to normal Time display.

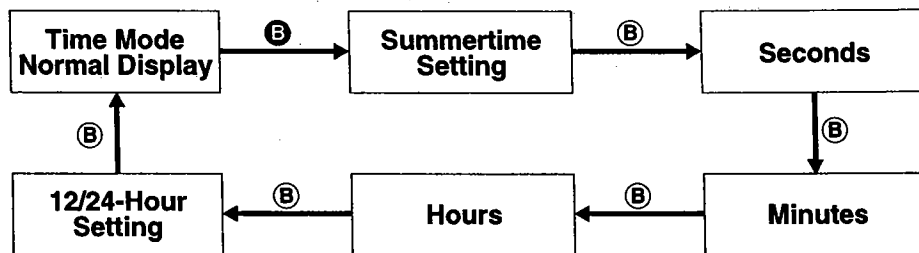

<Button Make>

- (B)** : Press button **(B)** once
- (B)** : Press button **(B)** for 2 seconds or longer

- Make sure that the AM/PM indication is correct when setting the time in the 12-hour display system.
- Auto-Return to the normal time display will be activated when the watch is left in the adjustment mode (including Summertime) for about 2 minutes.
- Instant Manual Return to normal Time display can be made by pressing button **(M)** in Time adjustment mode. (Instant Manual Return)

B. CALENDAR MODE

- If you press button **(A)** while the watch is in Calendar mode, the EL light will be switched on, and stay on for as long as you keep pressing the button.

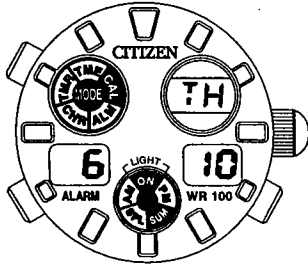

<To Adjust Calendar>

- (1) If you press and hold button **(B)** for 2 seconds or more while the watch is in normal calendar mode, the "Month" will start flashing, indicating that the watch is in adjustment mode. (Day of the week display will disappear).
- (2) Each time you press button **(B)**, adjustment section changes and begins to flash as shown below.
- (3) Press button **(A)** to adjust flashing section. (Press and hold button **(A)** for rapid advancement.)
- (4) Press button **(B)** or **(M)** to return to normal Calendar display.

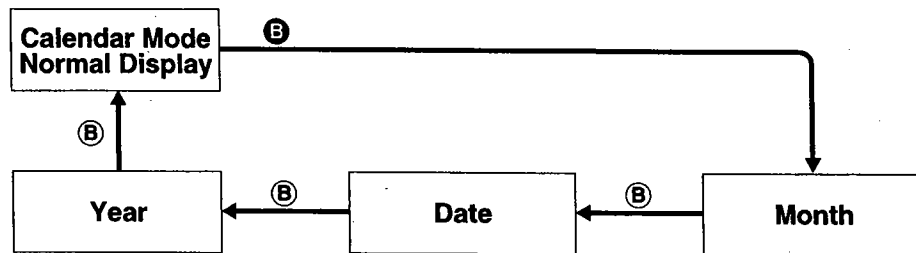

- Calendar can be set from 1998 through 2099.
- Auto-Return to normal calendar display will be activated when the watch is left in adjustment mode for about 2 minutes.
- Day of the week is automatically set with adjustment of Year, Month and Date.
- When Calendar is set to a non-existent date (e.g., February 30), display will automatically show the first day of next month when returned to normal mode.
- Month-end adjustments are not necessary since calendar is programmed to set automatically.
- If button **(M)** is pressed in adjustment mode, display will immediately return to normal calendar display.

C. ALARM MODE

[Normal Alarm Display]

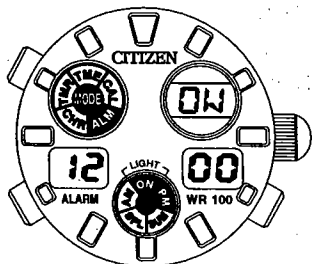

<To Set Alarm>

- (1) Press and hold button **(B)** in alarm mode (normal display) for more than 2 seconds. "Hour" starts flashing and may be adjusted.
- (2) Each time you press button **(B)**, adjustment position changes and figures begin to flash.
- (3) Press button **(A)** to set the time you want the alarm to sound. (Press and hold button **(A)** for rapid advancement.)
- (4) Press button **(B)** or **(M)** to return to Alarm mode (normal display).
 - If the watch is set to 12-hour display (AM-PM) in Time mode, Alarm will also be set to 12-hour display.

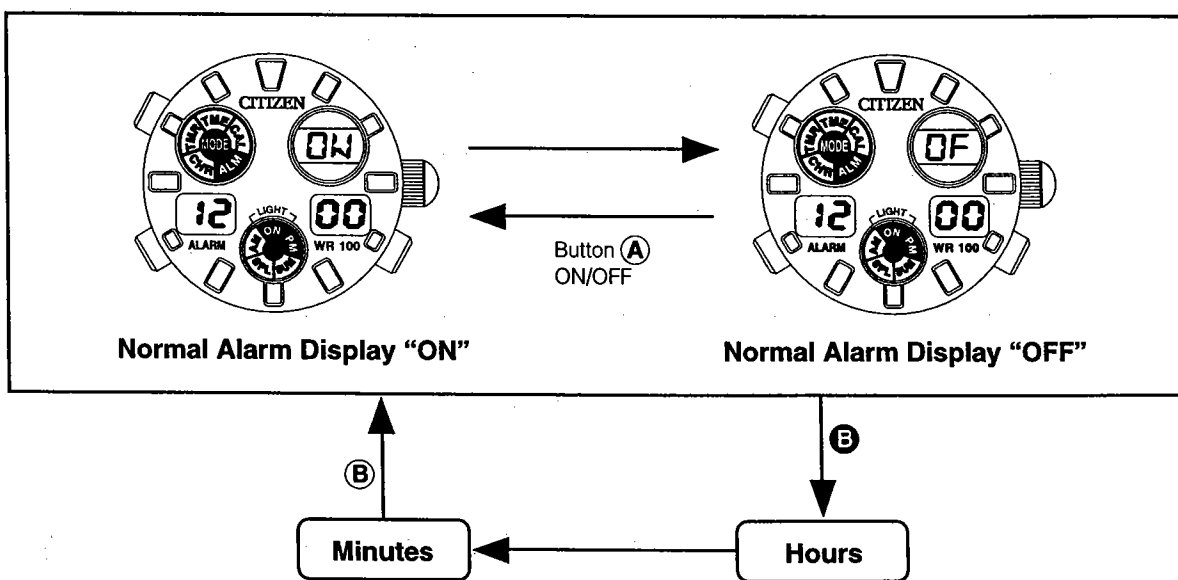

<To Switch Alarm ON/OFF>

- Press button **(A)** in Alarm mode to switch the alarm ON or OFF.

<Duration of Alarm Sounding and How to Stop the Alarm Sound>

- Alarm will sound for 20 seconds.
- Press any button to stop Alarm buzzer.

<Alarm Sound Monitor>

- Press button **(A)** and hold in Alarm mode to make the alarm monitor sound.

<Auto-Return>

- (1) When the watch is left in Alarm adjustment mode for more than 2 minutes, the display will automatically return to normal Alarm mode.
- (2) When the watch is left in normal alarm mode for about 2 minutes, the display will automatically return to normal Time mode.

<Instant Manual Return>

- Press button **(M)** in Alarm adjustment mode to return to Alarm mode (normal display).

D. CHRONOGRAPH MODE

- Chronograph measures in units of 1/100 of a second, up to "23 hours, 59 minutes 59 seconds". On reaching 24 hours of elapsed time, it resets to "00 minutes 00 seconds and 00" hundredths and stops.
- The confirmation tone will sound when you press the button.

[Chronograph Reset Position]

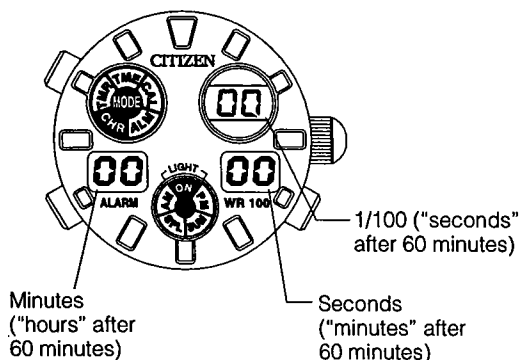

Display of Time Measurement

- Chronograph shows "Minutes", "Seconds" and "1/100 second" and will change to "Hours", "Minutes" and second" after 60 minutes.

<Elapsed Time Measurement>

- (1) Press button **(A)** to start/stop Chronograph.
 - ① Each time you press button **(A)** while in time measurement, start/stop is repeated.
 - ② EL light is turned ON for 3 seconds when counting is stopped.
- (2) Press button **(B)** when counting is stopped to reset Chronograph.

<Split Time Measurement>

- (1) Press button **(A)** to start/stop Chronograph.
- (2) Press button **(B)** while Chronograph is running. Split time will appear for 10 seconds.
 - ① "SPL" will flash while split time is displayed.
 - ② EL Light is turned on for 3 seconds at the time of split time operation.
- (3) Press button **(B)** when counting is stopped to reset Chronograph.

[Initial Chronograph Setting]

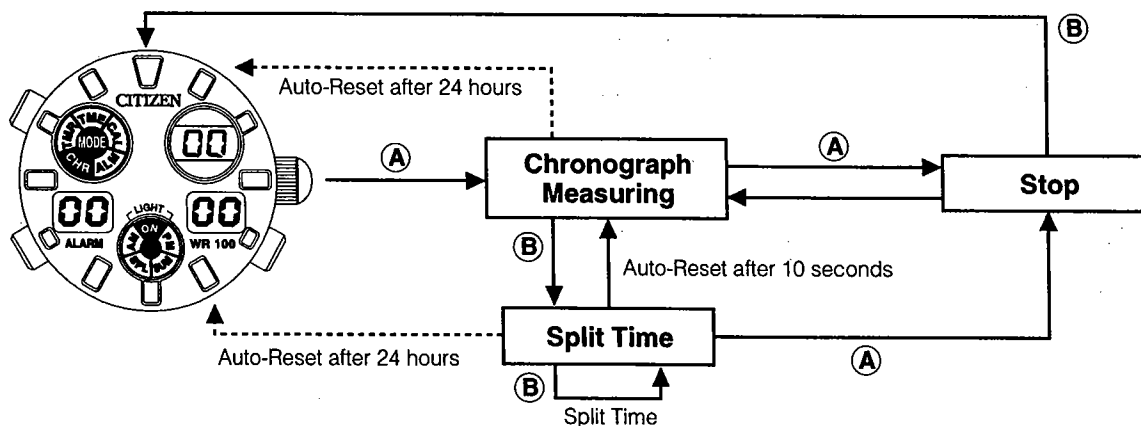

- ☆ If switched to another mode while Chronograph is running and then returned to Chronograph mode, the watch will show time measurement continuing even though mode was switched. (If switched while Split Time is shown, the watch will return to Chronograph running mode.)
 However, If Chronograph counting has exceeded 24 hours, the watch will return to Chronograph reset display.

E. TIMER MODE

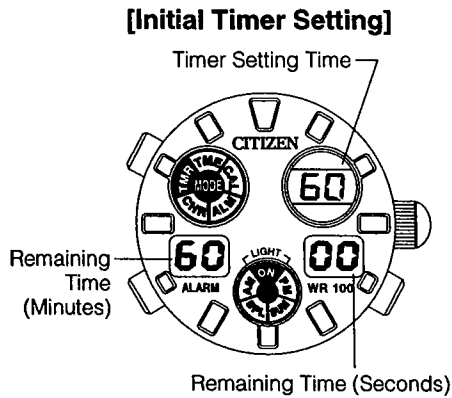

- Timer can be set in units of 1 minute up to 60 minute. When Timer countdown is finished, buzzer will sound for about 5 seconds and return to the Timer set time.

<To Set Timer>

- (1) If you press button **(B)** while the set time is flashing in timer mode, the set time will be reduced by one minute for each time you press and release the button. Continue until you reach the set time you want. (Press and hold button **(B)** to make rapid change to the set time.)

<To Use Timer>

- (1) Press button **(A)**. Timer starts countdown from set time.
- (2) Press button **(A)** to stop Timer during in the measurement. Press button **(A)** to start it again while in the "Stop" position.
 - Press button **(B)**, while Timer is in operation, to return to set time, and start the countdown again.
- (3) If you press button **(B)** while Timer is stopped, Timer will return to the set time.
 - The confirmation tone will sound when you press the button.

[Initial Timer Setting]

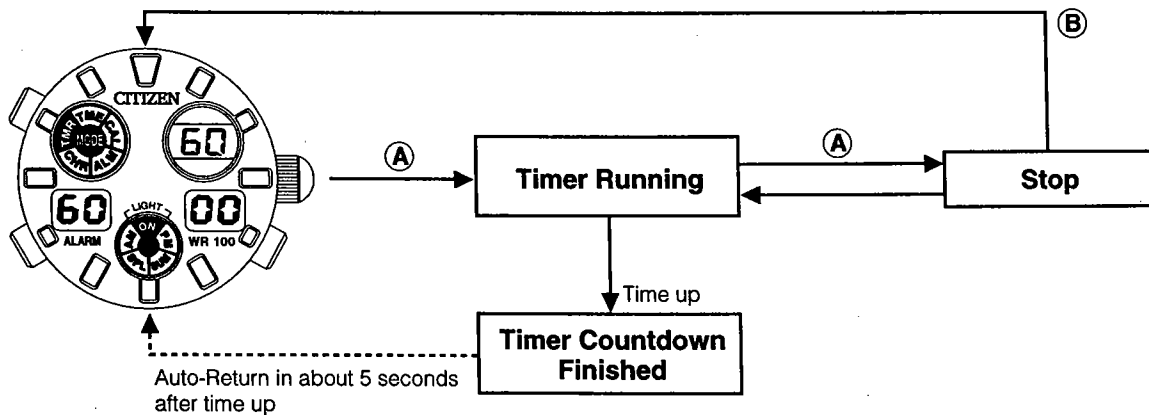

☆ If the watch is switched to another mode while Timer is in operation and then switched to Timer again, the watch will show countdown continuing. However, if countdown has been completed, the watch will return to initial Timer setting.

§8. ALL RESET FUNCTION

Use All Reset function to reset the watch after replacing the battery or if the watch is showing abnormal operation or display. All Reset function can be performed as follows:

- (1) Pull crown out.
- (2) press buttons **(A)**, **(B)** and **(M)** simultaneously. (All digital displays will disappear while pressing)
- (3) Release three buttons. (All digital segments are shown.)
- (4) Push crown in. (At this point, buzzer sounds in confirmation.)
This completes the All-Reset operation. Set each mode correctly before using the watch.

§9. DISASSEMBLY AND ASSEMBLY OF MOVEMENT

Disassemble the parts in order of ① → ⑳
 Assemble the part in order of ⑳ → ①

● Lubrication mark

- Ⓐ : A-Lube oil
- Ⓥ : V-Lube oil
- Ⓕ : F-Lube oil
- Ⓞ : CH-1 oil

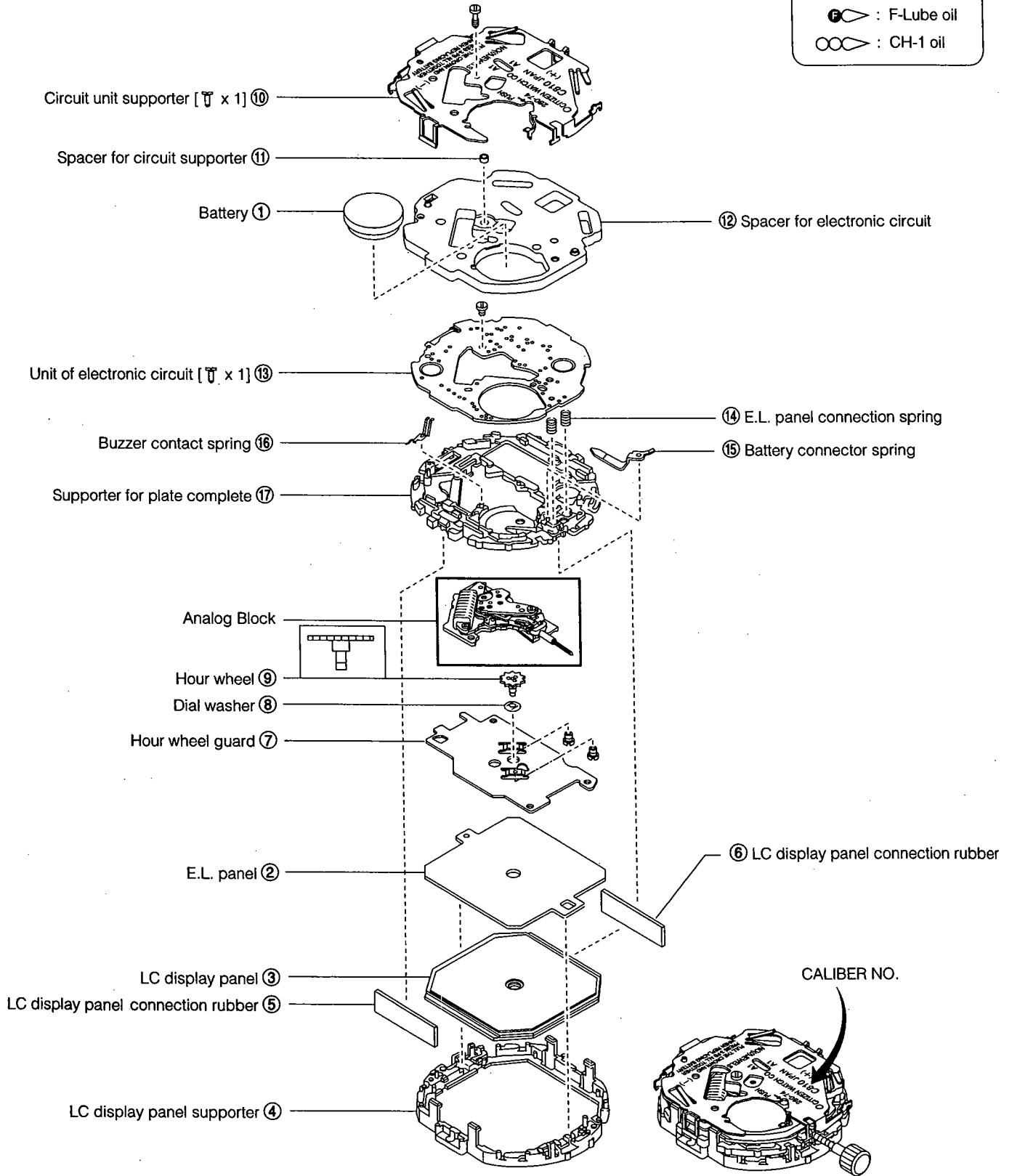

Installation of LC display panel

- ① Fit the LC display panel and E.L. panel to the LC display panel supporter, then install them togethert to the movement.

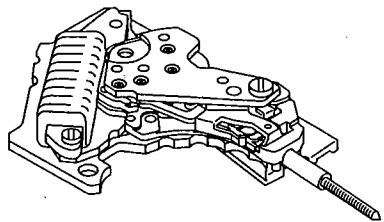
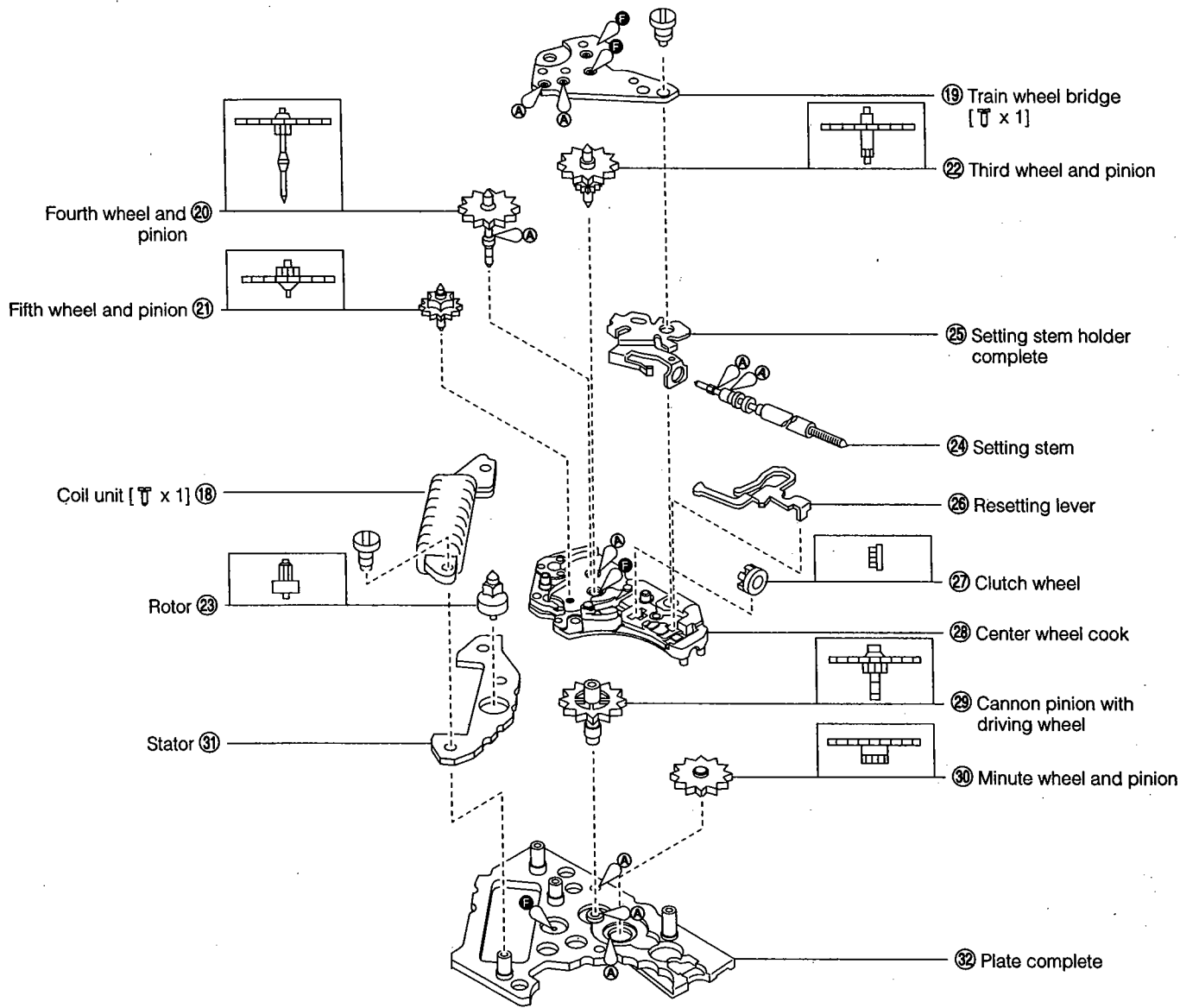

Analog Block

§10. TROUBLESHOOTING AND ADJUSTMENT

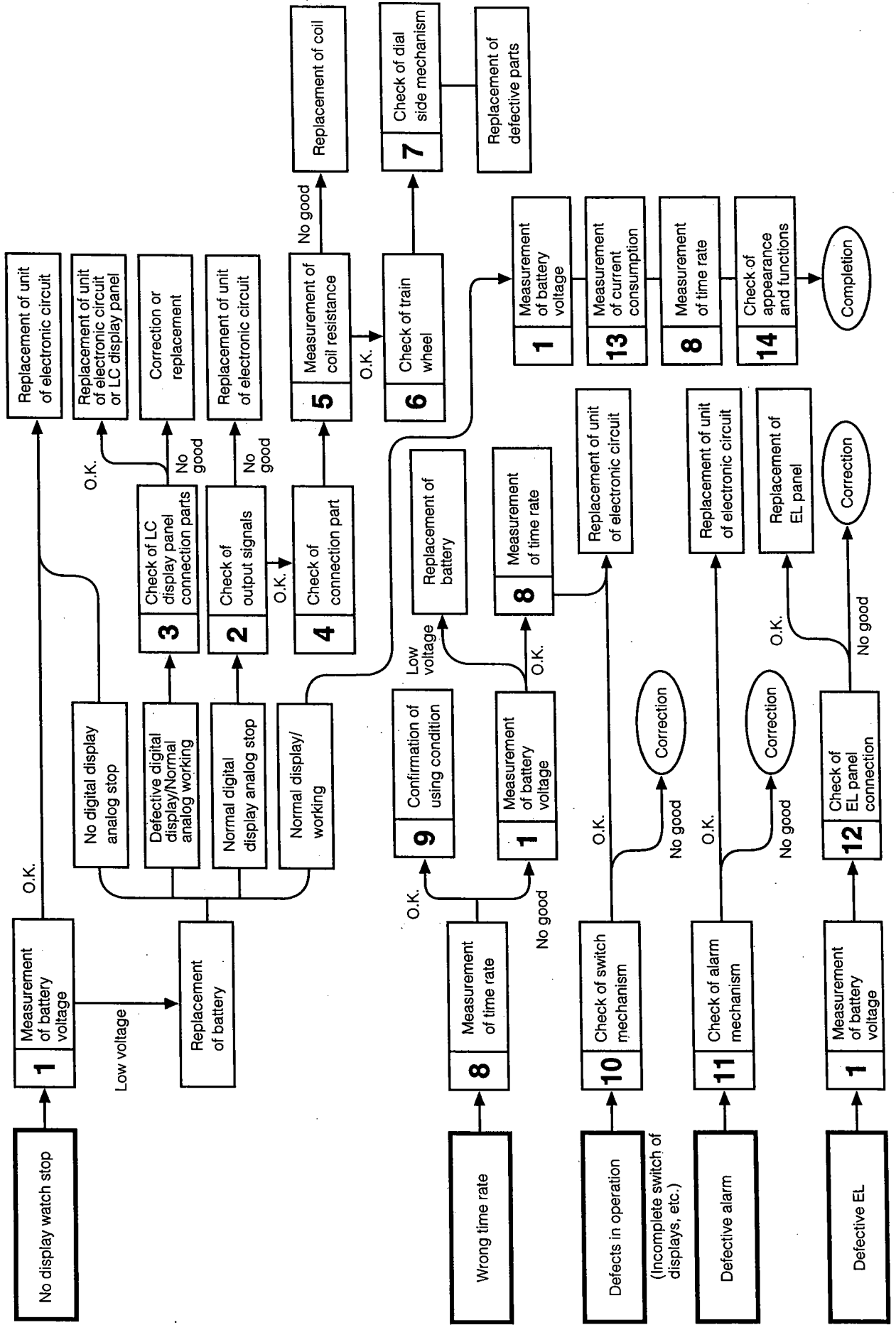

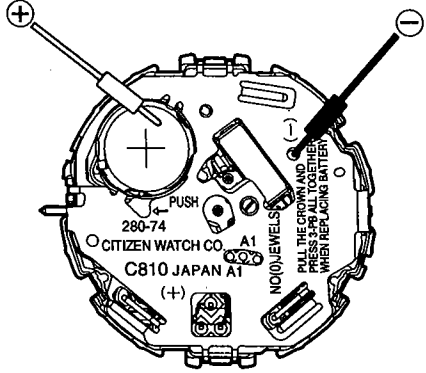
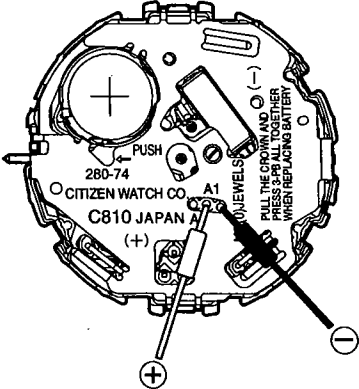
Check Points	How to Check	Results and Treatments
<p>① Measurement of battery voltage</p>	<p>[Refer to Technical Manual, Basic Course II-1-a]</p> <p><Tester range: DC 3V></p> 	<ul style="list-style-type: none"> • Over 1.5 V → Normal • Under 1.5 V → Replace the battery.
<p>② Check of output signals</p>	<p>[Refer to Technical Manual, Basic Course II-1-b]</p> <p><Tester range: DC 0.3V></p>  <p>(The tester lead pins have no polarity.)</p>	<ul style="list-style-type: none"> • The tester pointer swings every 1 second. → Normal • The tester pointer does not swing. → Check the connections parts. <p style="text-align: center;">↓</p> <ul style="list-style-type: none"> • The connections are normal. → Replace the unit of electronic circuit.
<p>③ Check of LC display panel and connection parts</p>	<p>[Refer to the Digital Section of Technical Manual, Basic Course II-2-a]</p> <ul style="list-style-type: none"> • Inspection of all segments Pull out the crown and push the three buttons at the same time to turn on all the segments, and check for defective ones. (Refer to §8. ALL RESET FUNCTION) • Continuity test on LC display panel, cell connection rubber and plate. Check the parts for stain, breakage, etc. 	<ul style="list-style-type: none"> • LC display panel, connection rubber or metal plate is not installed correctly. → Install correctly. • Parts are stained or dirty. → Remove stain and dirt. • Parts are cut broken or scratched. → Replace parts.
<p>④ Check of connection part</p>	<p>[Refer to Analog Section of Technical Manual, Basic Course II-2-a]</p>	

Check Points	How to Check	Results and Treatments
<p>⑤ Measurement of coil resistance</p>	<p>[Refer to Technical Manual, Basic Course II-1-c]</p> <ul style="list-style-type: none"> Remove the unit of electronic circuit, then measure the resistance of coil. The tester lead pins have no polarity. <p style="text-align: right;"><Tester range: R x 10Ω></p>	<ul style="list-style-type: none"> 1.9 kΩ ~ 2.3 kΩ → Normal Outside range of 1.9 kΩ ~ 2.3 kΩ → Replace coil unit.
<p>⑥ Check of train wheel</p>	<p>[Refer to Technical Manual, Basic Course II-2-b]</p> <ul style="list-style-type: none"> Check clearance of each wheel. Check rotor for dust and oil. 	
<p>⑦ Check of dial-side mechanism</p>	<p>[Refer to Technical Manual, Basic Course II-2-c]</p> <ul style="list-style-type: none"> Confirm all parts are not deformed and are lubricated properly. 	
<p>⑧ Measurement of time rate</p>	<p>[Refer to Technical Manual, Basic Course II-2-d]</p> <ul style="list-style-type: none"> Since this watch uses the D.F.C. (digital frequency control) method and has no control terminal, there is no way of adjusting its time rate in the field. (Measurement is made in a 10-second range.) 	<p>The watch loses or gains a substantial amount of time. → Replace the unit of electronic circuit.</p>
<p>⑨ Confirmation of using condition</p>	<p>[Refer to Technical Manual, Basic Course II-2-e]</p>	
<p>⑩ Check of switch mechanism</p>	<p>1. Inspection of movement.</p> <ul style="list-style-type: none"> Press the switch spring of circuit unit supporter with tweezers, etc. to contact it to plate complete, and confirm the switching function. Check for removal of pattern of electronic circuit unit, deformation of switch return spring, etc. <p>2. Inspection of push button:</p> <ul style="list-style-type: none"> Check push button for deformation, stain, etc. <div style="border: 1px solid black; padding: 5px; margin-top: 10px;"> <p>(Note) Be sure to apply silicone oil to the packing of push button for waterproofness and smooth operation.</p> </div>	<ul style="list-style-type: none"> Switching function is normal. → Inspect push button. Pattern is removed or deformed. → Replace defective parts. Push button is stained or deformed. → Remove stain, or replace push button.

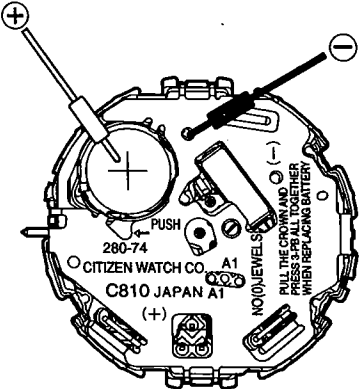
Check Points	How to Check	Results and Treatments
<p>⑪ Check of alarm mechanism</p>	<p>[Refer to Technical Manual, Basic Course II-1-d]</p> <p>*1. Set the movement in the case, and check output of alarm signal with the case back removed.</p> <p>(1) Set the watch in alarm mode.</p> <p>(2) Apply ⊕ lead pin to battery surface and ⊖ lead pin to pattern of buzzer contact spring, then press (A) button.</p> <p style="text-align: right;"><Tester range: DC 0.3V></p>  <p>*2. If the output of alarm is normal, perform the following inspection.</p> <ul style="list-style-type: none"> • Check the piezo-electric element of vibrating plate for cracks and breakage. • Check the buzzer contact spring for bend and deformation. • Check the pattern of electronic circuit unit for dust and stain. 	<ul style="list-style-type: none"> • Tester pointer does not swing. → Replace the electronic circuit unit. <p style="text-align: center;">↓</p> <ul style="list-style-type: none"> • Tester pointer swings. → Normal <p style="text-align: center;">↓</p> <ul style="list-style-type: none"> • Perform inspection in *2. <p style="text-align: center;">↓</p> <p>Normal indication. → O.K.</p>
<p>⑫ Check of EL panel connection</p>	<p>1. Confirmation of battery voltage</p> <p>2. Check of EL panel connection</p> <ul style="list-style-type: none"> • Check the EL panel for breakage. Particularly check the electrode pattern on the back side for stain, breakage, etc. which can lower electrical continuity. • Confirm that the EL connection spring is in contact with the EL panel and electrode pattern normally. <p>If any cause is not found by inspections 1 and 2, the EL panel must have been deteriorated. Replace the EL panel.</p>	<ul style="list-style-type: none"> • Over 1.5 V → Check EL panel connection. • Under 1.5 V → Replace battery. • Trouble of EL panel → Replace EL panel. • Deformation of EL connection spring → Repair or replace.

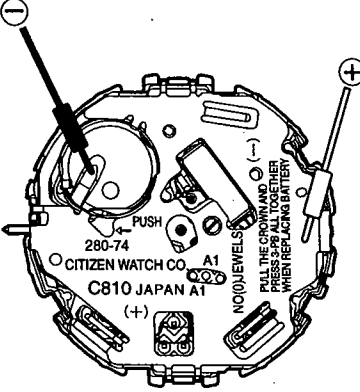
Check Points	How to Check	Results and Treatments
<p>⑬ Measurement of current consumption</p>	<p>[Refer to Technical Manual, Basic Course II-1-f]</p> <p>(1) Set the battery to tester.</p> <p>(2) Set the lead bars of the tester to the module. Pull the crown and push the three buttons at the same time, then push the crown (The all-reset operation procedure). Then, measure the current consumption.</p> <p style="text-align: center;"><Use the tester range: DC 10μA></p> <div style="text-align: center;">  </div> <p>★ Precautions for measurement</p> <ol style="list-style-type: none"> 1. Be sure to measure according to the above procedure. If measurement is not performed according to the above procedure, the watch may indicate and operate abnormally and the current power consumption cannot be measured correctly. 2. When the lead bars are applied to the measurement parts, the meter reading may exceeds the maximum value. In this case, wait for about 30 seconds, then measure again. <div style="border: 1px solid black; padding: 5px; margin-top: 10px;"> <p>Influence of light</p> <p>Avoid taking measurements under an incandescent lamp or direct sunshine, because this may cause the current value to increase.</p> <p>The light of a fluorescent lamp has no influence on current consumption.</p> </div>	<ul style="list-style-type: none"> • Current consumption of the movement <ul style="list-style-type: none"> Under 3.2 μA. → Normal Over 3.2 μA. → Inspect train wheel and dial side mechanism, and remove dust and stain and oil. • Pull the crown to measure the current consumption under the reset state. <ul style="list-style-type: none"> Under 1.1 μA. → Normal Over 1.1 μA. → Electronic circuit unit is defective. <p style="text-align: center;">↓</p> <p style="text-align: center;">Replace the electronic circuit unit.</p>
<p>⑭ Check of appearance and functions</p>	<p>[Refer to Technical Manual, Basic Course II-2-f]</p> <ul style="list-style-type: none"> • Check inside of case for dust and stain. • Check operation of setting switches for normality. • Check segment for normality (See ③ Check of LC display panel and connection part.) <p>* Be sure to apply silicone oil to packing of each push button. It is necessary for water resistance and smooth operation.</p>	