

TECHNICAL INFORMATION

CITIZEN QUARTZ

Cal. No. C60✕

Cal. No. C61✕

Contents

§1. OUTLINE	1
§2. SPECIFICATIONS	1
§3. BEFORE USE	2
§4. NAME OF PARTS	2
§5. SPECIAL FUNCTIONS OF THE SOLAR POWERED WATCH	3
§6. SPECIAL CARE FOR USING SOLAR WATCH	5
§7. RECHARGING SOLAR WATCH	5
§8. TIME REQUIRED FOR RECHARGING	5
§9. SETTING THE ANALOG TIME DISPLAY	6
§10. SWITCHING DIGITAL MODES (FUNCTIONS)	6
§11. USING DIGITAL MODES (FUNCTIONS)	7
A) To Call Up Time, Calendar or Alarm in Each City.....	7
B) Time Mode	8
C) Calendar Mode	9
D) Alarm Mode.....	10
E) Chronograph Mode	11
F) Timer Mode (CAL. C600 only)	12
G) Using Race Timer (CAL. C610 only).....	13
H) Zone Set Mode (CAL. C600 only).....	15
§12. ALL RESET FUNCTION	16
§13. DISASSEMBLY AND ASSEMBLY OF MODULE	17
§14. TROUBLESHOOTING AND ADJUSTMENT	19

§1. OUTLINE

This analog/digital combination solar watch works on Citizen's environmentally clean Eco-Drive system. The Eco-Drive converts the energy of light to electrical energy using the solar charger set in the dial of the watch, generating power to operate various analog and digital functions. The watch also has the world time display function. By operating the buttons, you can easily check the time and day in 24 major cities of the world.

§2. SPECIFICATIONS

Caliber No.		C600	C610
Type		Analog/digital combination display solar watch	
Module size		ø31.8 x 6.56t	
Accuracy		±20 Seconds per month at 5–35°C when used in normal temperatures	
IC		C/MOS-LSI, 2pcs.	
Operation temperature range		0°C ~ +55°C (32°F ~ 131°F)	
Time adjustment		Impossible (No termination for adjustment in the market)	
Measurement gate		10 sec	
Display function	Analog	Time: Hours, Minutes, Seconds	
	Digital	Time: Hours, Minutes, Seconds. 12/24-hour display, Summertime, City time zone setting	
		Calendar: Month, Date, Day, (Year), City time zone setting	
	Alarm	Hour, Minutes, (AM/PM). ON/OFF, City time zone setting	
	Chronograph	12-hour measurement (in 1/100 sec.), Split time measurement	
	Timer	60-minute countdown (in 1 minute units)	
	Race timer		15 different lengths of setting
	Zone set	Hours, Minutes, Seconds, (AM/PM), City time zone setting	
Additional function		Insufficient recharging warning feature	
		Quick start feature	
		Time setting indication feature	
		Overcharging prevention feature	
Secondary battery used	Part No.	295-38	
	Capacitors symbol	MT920	

§3. BEFORE USE

In the watch, a secondary battery is used to store electric energy.

This secondary battery is an environmentally clean energy source since it does not contain mercury or other pollutive materials. Once the battery is charged to the full, the watch will keep on running for 2.3 months without recharging.

If the watch does not work normally, the secondary battery may not be charged sufficiently. In this case, explain that the watch needs to be placed and recharged under a fluorescent or incandescent lamp at distance of approximately 20cm for approximately 40 hours or under the direct sunlight for approximately one hour.

<For Trouble Free Use>

Be sure that the solar battery is sufficiently charged to ensure smooth operation of Alarm, Chronograph and other functions. Since the watch has an Overcharge Prevention function, you can charge the battery without worrying about overcharging. We recommend that you recharge the watch every day.

§4. NAME OF PARTS

[CAL. C600]

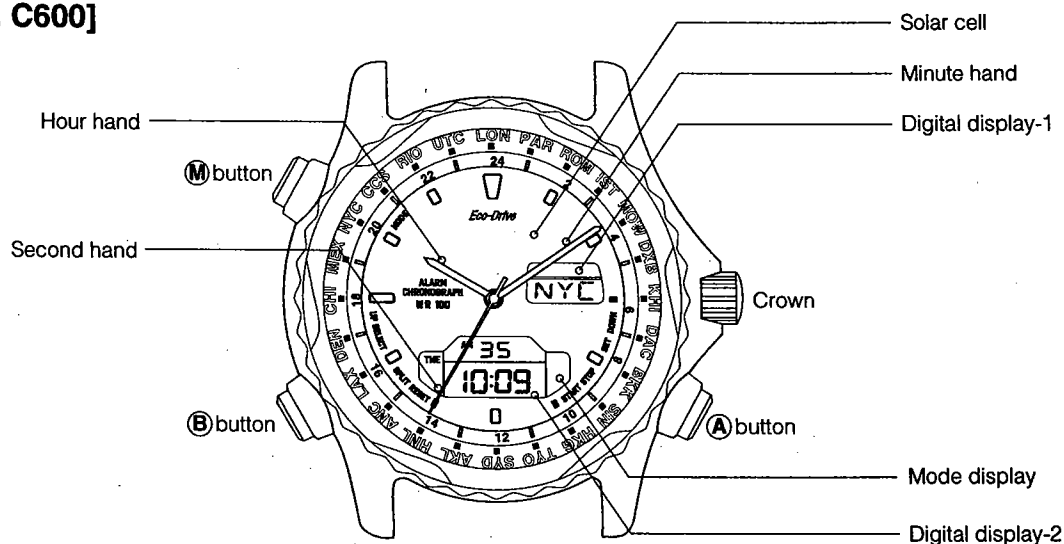

[CAL. C610]

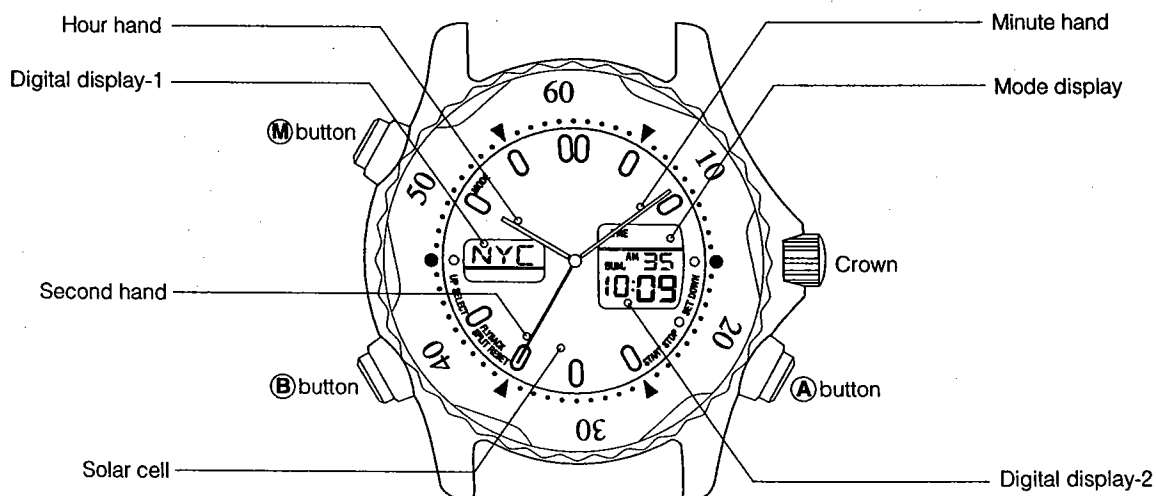

§5. SPECIAL FUNCTIONS OF THE SOLAR POWERED WATCH

If solar cell becomes insufficiently charged, a warning function comes into operation and the display changes, as below.

■ Analog display

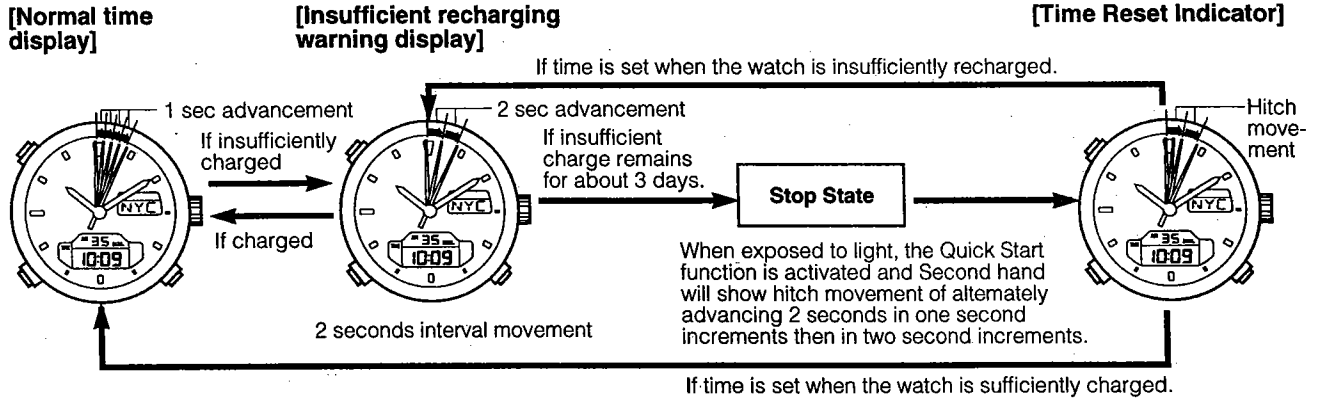

■ Digital display

[CAL. C600]

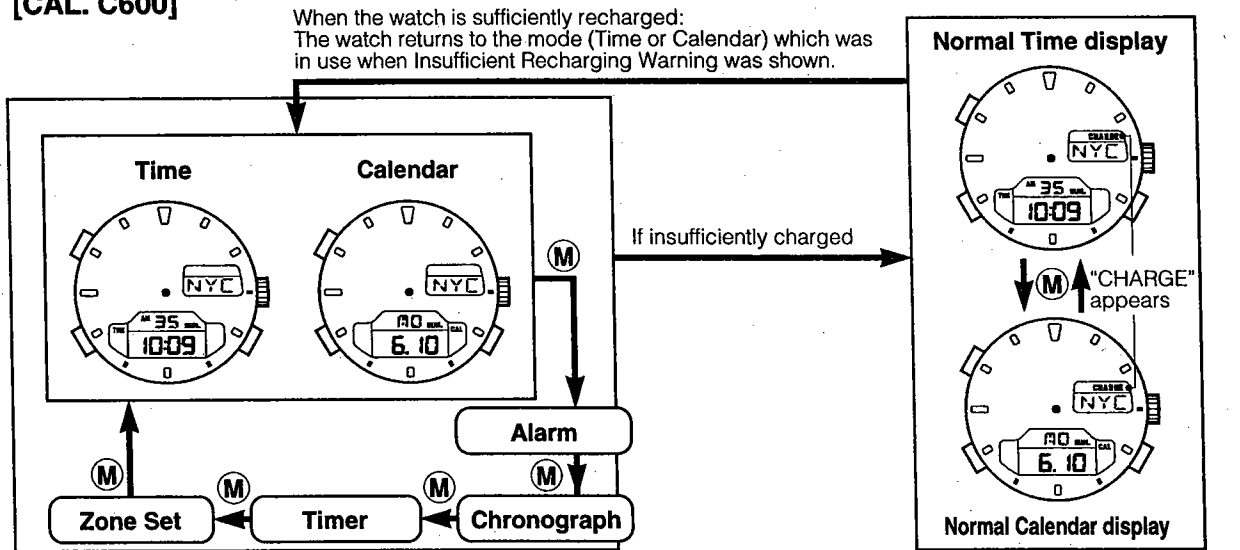

[CAL. C610]

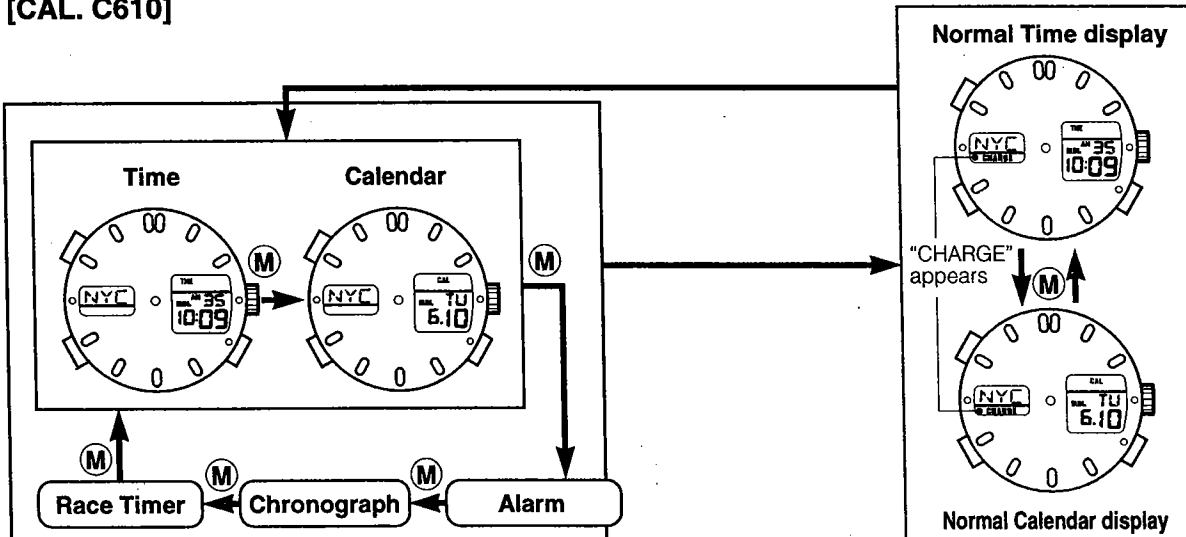

[When the watch is insufficiently charged]

- ① "CHARGE" will appear in digital display-1.
- ② If the watch has been set to Time or Calendar mode, it will keep the mode in use when Insufficient Recharging Warning was shown.
- ③ If the watch has been set to Alarm, Chronograph, or other mode, it will automatically switch to Time display mode.
- ④ If Chronograph measurement, Timer (Cal. C600) or Race timer (Cal. C610) countdown is in progress, the watch will automatically stop operation and switch to Time display mode.
- ⑤ It is possible to switch the mode between Time and Calendar and to adjust each display. (Switching to other modes cannot be done.)
- ⑥ Alarm sound will not work.

[When the watch is sufficiently recharged]

- ① Insufficient Recharging Warning ("CHARGE" mark) disappears and the watch returns to normal Time or Calendar mode.
- ② Mode switching by the **(M)** button will become possible when the insufficient recharging warning has released in this case readjust display of each mode before use.

■ Insufficient Recharging Warning Feature

Analog display: **Second hand starts advancing 2 seconds at a time indicating the watch is insufficiently charged.** The watch keeps correct time even when power charge is insufficient. The Watch will stop unless this condition is corrected within about 3 days.

Digital display: **"CHARGE" appears in digital display-1.**

■ Quick Start Feature

The watch will stop if solar cell has completely lost its power charge.

When watch face is exposed to light, Second hand will start advancing irregularly (hitch movement) after approx. 10 seconds (Time Reset Indicator). Length of time required for restarting Second hand will depend on intensity of light.

If light is blocked when solar battery is not fully charged, the watch will stop again.

■ Time Setting Indication Feature

If the watch is exposed to light after it has stopped, it will activate the Quick Start function and start moving again. However, Second hand will show hitch movement to indicate the need to reset to the correct time.

In this case, reset time. Otherwise, Second hand will continue to show irregular movement. If time is reset when power charge is too low, Insufficient Recharging Warning and Time Reset Indicator (Second hand advancing hitch movement) will appear again.

- Be sure to set Analog time, Calendar and other modes after adjusting display to the correct time.

■ Overcharging Prevention Feature

When secondary battery is charged fully, Overcharging Prevention function will activate automatically.

§6. SPECIAL CARE FOR USING SOLAR WATCH

Make sure that solar cell is always charged to sufficient level. When you are wearing clothes with long sleeves, power charge may become too low because the watch is not exposed to light.

- Always keep the watch exposed to light when not using it. This will assure correct running of the watch.

WARNING Never use batteries other than the secondary battery specified for this watch. The watch is not structurally designed to operate on any other type of battery. However, if by chance a silver battery or other batteries are used, there is a danger that the battery will be overcharged and burst causing damage to the watch and the user. When replacing secondary battery, be sure to use the designated product.

§7. RECHARGING SOLAR WATCH

CAUTION The watch will be damaged during recharging if it gets too hot (about 60°C/140°F or more). Avoid recharging at high temperatures. When recharging the watch under an incandescent lamp, in particular, place it sufficiently apart from the lamp (at the distance of about 50cm).

Don't recharged near an incandescent lamp, halogen lamp and other high temperature light sources or on a car dashboard and other heat accumulating places.

- Solar battery may not be fully charged if placed in a dimly lighted place.

§8. TIME REQUIRED FOR RECHARGING

Recharging time differs depending on model of the watch (color of the dial). The table below shows standard time required for recharging.

* Recharging time is length of time in which the watch is continuously exposed to light.

Illuminance (luxes)	Environment	Recharging time		
		For one day's use	From stopped state to the one second movement	Until fully charged
500	Inside ordinary office	3 hours 20 minutes	22 hours	242 hours
1,000	60-70cm under fluorescent light (30W)	1 hours 40 minutes	10 hours	120 hours
3,000	20cm under fluorescent light (30W)	35 minutes	3 hours	40 hours
10,000	Exterior, cloudy	10 minutes	1 hour	12 hours
100,000	Exterior, summer, sunny	50 seconds	5 minutes	1 hour

Full recharging time: time required for recharging fully from stopped state.

Recharging time for one day's use: recharging time required for the watch to run for one day.

§9. SETTING THE ANALOG TIME DISPLAY

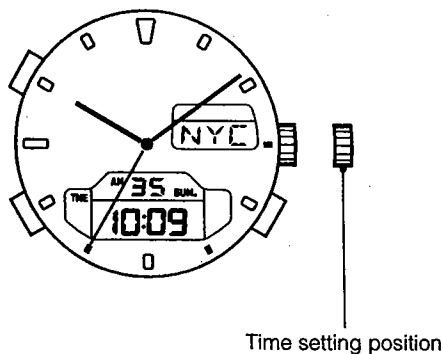

- (1) Pull the crown out and stop the second hand.
- (2) Turn the crown and set the hands to the correct time.
- (3) Press the crown back in to finalize the setting and start the watch.

How to adjust the watch to the correct time.

Stop the second hand at the "0" position. Move the minute hand to a few minutes past the time you want to set, then move it back to the correct time. Press the crown back in to synchronizing to the correct time.

§10. SWITCHING DIGITAL MODES (FUNCTIONS)

• CAL. C600:

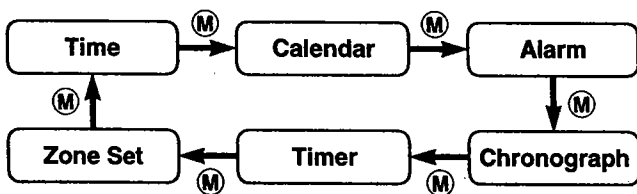

In addition to Time mode, this watch has 5 other modes; Calendar, Alarm, Chronograph, Time and Zone Set.

Press (M) button to switch to desired mode. Mode mark in digital display section indicates the mode in which the watch is presently set.

• CAL. C610:

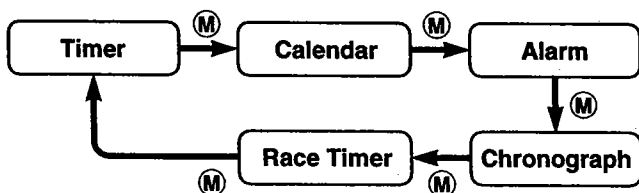

In addition to Time mode, this watch has 4 other modes; Calendar, Alarm, Chronograph, and Race Timer.

- The Auto-return to the Time mode will be activated when the watch is left in the Alarm, or Zone Set mode (CAL. C600 only) for more than 2 minutes without any operation.

§11. USING DIGITAL MODES (FUNCTIONS)

A) To Call Up Time, Calendar or Alarm in Each City

- (1) Press **(M)** button to set the watch to Time, Calendar or Alarm mode.
- (2) Press **(A)** or **(B)** button to call up desired city.
 - If **(A)** button is pressed, City Names and Time will appear in westward order.
 - If **(B)** button is pressed, City Names and Time will appear in eastward order.

■ Time Difference Between The Local Time and UTC

(Unit: hour)

Indication	City	Time difference	Indication	City	Time difference
UTC	Universal time coordinated	±0	TYO	Tokyo	+9
LON	London	±0	SYD	Sydney	+10
PAR	Paris	+1	AKL	Auckland	+12
ROM	Rome	+1	HNL	Honolulu	-10
IST	Istanbul	+2	ANC	Anchorage	-9
MOW	Moscow	+3	LAX	Los Angeles	-8
DXB	Dubai	+4	DEN	Denver	-7
KHI	Karachi	+5	CHI	Chicago	-6
DAC	Dacca	+6	MEX	Mexico City	-6
BKK	Bangkok	+7	NYC	New York	-5
SIN	Singapore	+8	CCS	Caracas	-4
HKG	Hong Kong	+8	RIO	Rio de Janeiro	-3

↑ Press **(B)** button →
 → Press **(A)** button ←

■ Setting City Names and Time ON/OFF (CAL. C600 only)

If a City has been set "OF" (OFF) in Zone Set mode, you cannot call up this City and its Time (Calendar or Alarm) by pressing **(A)** or **(B)** button. In this case, the watch will call up the next City which has been set "ON" and show its Time (Calendar or Alarm).

B) Time Mode

If you set the time for any of the 24 cities, time of all other cities will be automatically adjusted.

[CAL. C600]

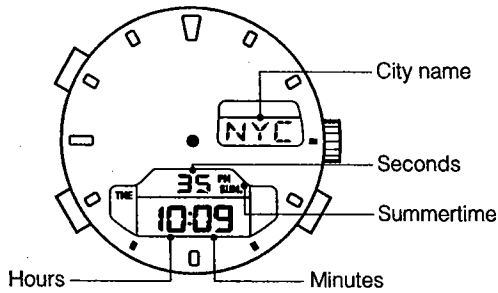

[CAL. C610]

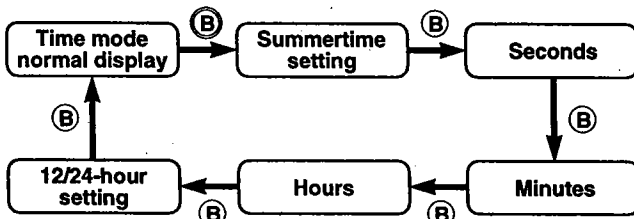
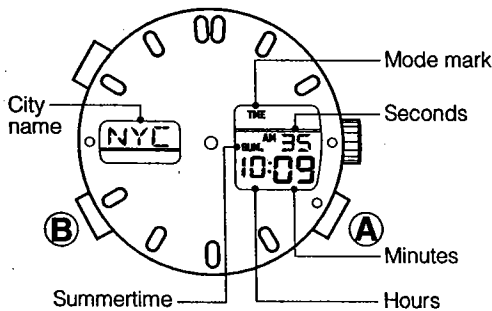

(B) : Press and hold **(B)** button for 2 seconds or longer.

(B) : Press **(B)** button once.

To set to Summertime

- (1) Press **(M)** button to switch to Time Mode.
- (2) Press **(A)** or **(B)** button to select a City.
- (3) Press and hold **(B)** button for 2 seconds or longer. "ON SUM" or "OF SUM" will flash.
- (4) Press **(A)** button while "ON SUM" or "OF SUM" is flashing. Each time **(A)** button is pressed, "ON" and "OF" change, indicating that the watch is in Summertime adjustment mode.

Note: Summertime cannot be set for UTC (universal time coordinate).

- When Summertime is set, "SUM" will appear and the hour will advance one unit.

Setting Time

<To adjust Seconds>

- (1) Press **(B)** button in Summertime adjustment mode. Seconds will flash.
 - Note:** If the watch is set to UTC, press **(B)** button for more than 2 seconds. Seconds will flash for adjustment.
- (2) Press **(A)** button while seconds are flashing, seconds will return to "00" and restart.
 - If seconds show 30 thru 59, minutes display will advance on minute.

<To adjust Hours and Minutes>

- (1) Press **(B)** button while Seconds are flashing. Minutes will flash.
- (2) Press **(A)** button and adjust Minutes.
- (3) Each time you press **(B)** button, adjustment section changes and begins to flash as shown in the diagram.
- (4) Press **(A)** button to adjust flashing section. Press and hold **(A)** button for rapid advancement.
- (5) Press **(B)** button again after switching to 12/24-hour display to return to normal time display.

- Make sure that the AM/PM indication is correct when setting the time in the 12-hour display system.
- Auto-Return to the normal time display will activate when the watch is left in the adjustment mode for more than 2 minutes.
- While in the adjustment mode the watch will be directly returned to the normal time display by pressing the **(M)** button.
- When summertime is set in the Time Mode, it will be automatically synchronized to the Alarm and zone set mode (CAL. C600 only).

C) Calendar Mode

If you set Calendar for any of the 24 cities, Calendar of all other cities will be automatically adjusted.

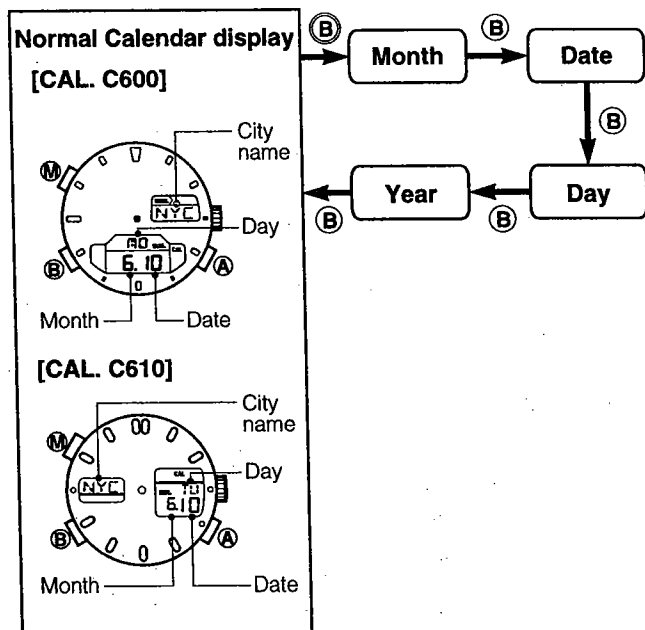

To adjust Calendar

- (1) Press (M) button to switch to Calendar mode.
- (2) Press (A) or (B) button to select a City for adjustment.
- (3) Press and hold (B) button for more than 2 seconds. Month will flash.
- (4) Press (A) button to adjust Month. Press and hold (A) button for rapid advancement.
- (5) Each time you press (B) button, adjustment section changes and start flashing as shown in the diagram.
- (6) Press (A) button to adjust flashing section.
- (7) Press (B) button again to return to normal Calendar display.

■ Year Setting

- Calendar can be set from 1996 through 2099.

■ Auto-Calendar function

- Month end adjustment will be made automatically.
- If Calendar is set to a nonexistent date (e.g., February 30), display will automatically show first day of next month.

■ Auto-Return function

- If the watch is left in adjustment mode for more than 2 minutes without any buttons being operated, Auto-Return will activate and return to normal Calendar display.

■ Instant Manual Return

- Instant Manual Return to normal Calendar display can be made by pressing (M) button in Calendar adjustment mode.

D) Alarm Mode

[CAL. C600]

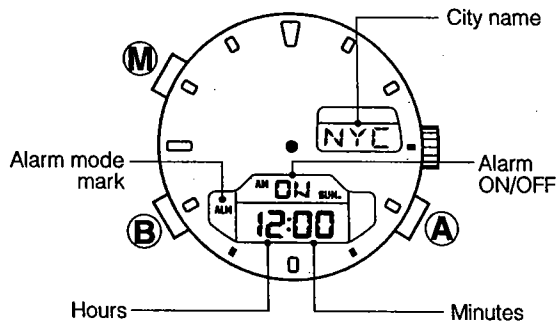

Setting Alarm

- (1) Press **(M)** button to switch the watch to Alarm mode.
- (2) Press **(A)** or **(B)** button to select City.
- (3) Press and hold **(B)** button for more than 2 seconds. "ON" or "OF" will flash. (When you press **(B)** button at this time, the name of next City will appear for an instant and then return to the City initially set.)
- (4) "ON" and "OF" change each time **(A)** button is pressed.
- (5) Press **(B)** button. Hours will flash.
- (6) Press **(A)** button and adjust Hours.
 - Press and hold **(A)** button for rapid advancement.
- (7) Press **(B)** button again. Minutes will flash.
- (8) Press **(A)** button and adjust Minutes.
- (9) Finally press **(B)** button to return to normal Alarm display.

[CAL. C610]

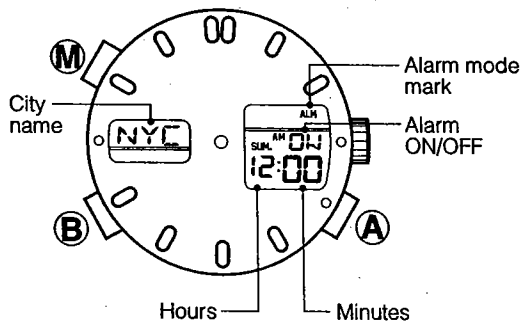

■ Alarm Buzzer

- Alarm will sound for 10 seconds.
- Press any button to stop Alarm buzzer.

■ Alarm Monitor

- To monitor Alarm buzzer, press **(A)** button and hold for more than 2 seconds when the watch is set to normal Alarm display. (Alarm sound will continue while **(A)** button is being pressed.)

■ 12/24-Hour display

- If the watch is set to 12-hour display in Time mode, Alarm will also be set to 12-hour display. Make sure that AM/PM is correct when setting Alarm.

■ Auto-Return function

- If the watch is left in Alarm adjustment mode for more than 2 minutes, it will automatically return to normal Alarm display.
- If the watch is kept in normal Alarm display mode for more than 2 minutes, it will automatically return to normal Time display.

■ Instant Manual Return

- Press **(M)** button in Alarm adjustment mode to return to normal Alarm display.

E) Chronograph Mode

Chronograph measures in units of 1/100 of a second, up to 11 hours 59 minutes, 59 and 99 hundredths seconds. After finishing 12-hour measurement, it will return to reset state (all digits are zero) and stop. You can also check split times while using Chronograph.

[CAL. C600]

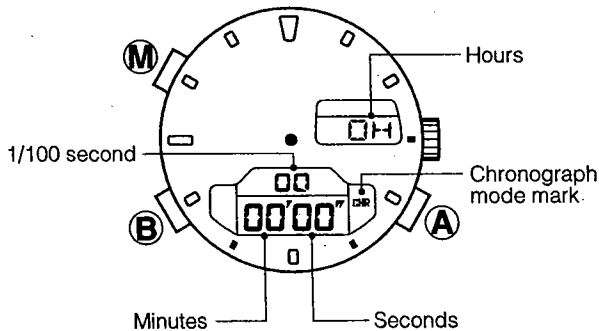

Elapsed Time measurement

- (1) Press **(A)** button to start/stop Chronograph.
 - (2) If **(B)** button is pressed when Chronograph is stopped, it will return to reset state.
- You will hear beep sound each time you press **(A)** or **(B)** button to start/stop or reset Chronograph. (Different tones will sound for start and stop.)

[CAL. C610]

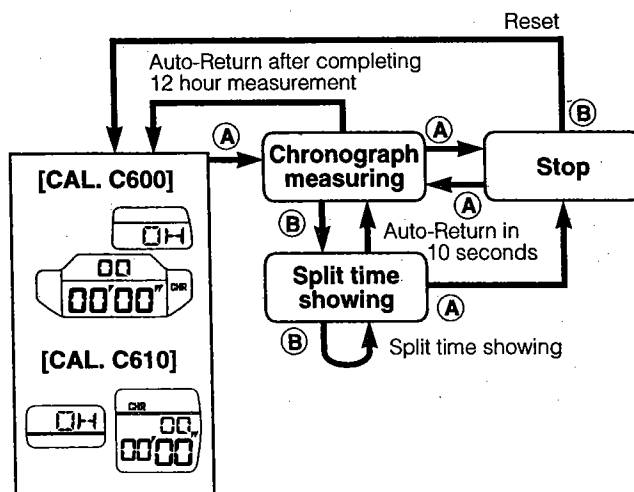
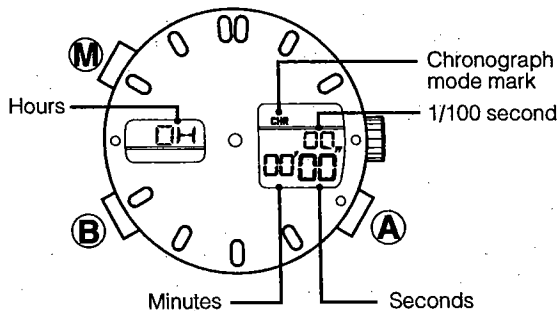

Split Time Measurement

- (1) Press **(A)** button to start/stop Chronograph.
 - (2) Press **(B)** button while Chronograph is running. Split time will appear for 10 seconds.
- "SPLIT" will flash while split time is shown.
- (3) Press **(B)** button while measurement is stopped to reset Chronograph.
- You will hear the beep sound each time you press **(A)** or **(B)** button to start/stop or reset Chronograph and to call up split time.

- If the watch is switched to another mode while Chronograph is in operation (reset, measuring or stopped) and then switched to Chronograph again, the watch will return to the initial state of use (if Chronograph was showing split time, it will return to measuring state.) If measuring has exceeded 12 hours, Chronograph stops and returns to reset state.

F) Timer Mode (CAL. C600 only)

- Timer can be set in units of 1 minute up to 60 minutes. When Timer countdown is finished, buzzer will sound for approx. 5 seconds and Timer will return to the initially set time.

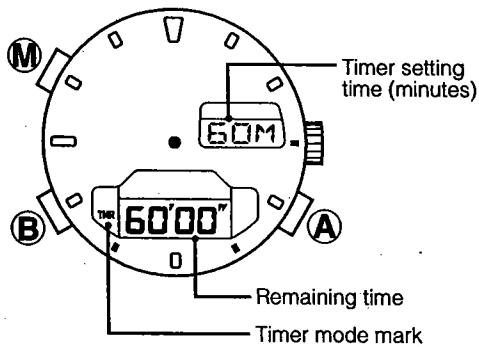

To set Timer

- (1) Press **M** button and switch to Timer mode.
- (2) Press **B** button until desired setting time is shown. Setting time will decrease minute-by-minute from 60 minutes. (Press and hold **B** button to make rapid change of setting time.)

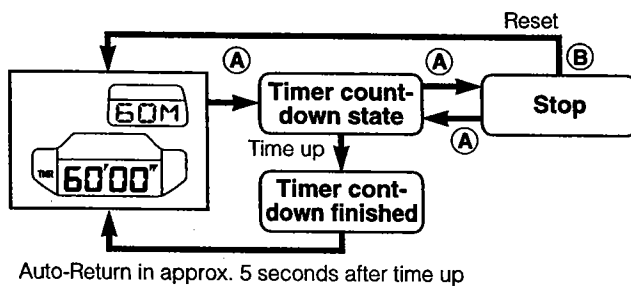

To use Timer

- (1) Press **A** button to start Timer.
- (2) To stop Timer, press **A** button while count-down is in progress. Press **A** button to start it again.
- (3) If you press **B** button while Timer is stopped, Timer will return to the initially set time.
 - You will hear a beep sound each time you press **A** button to start/stop or reset Timer. (Different tones will sound for start and stop.)
- (4) When Timer countdown is finished, watch will sound for approx. 5 seconds, after which Timer will automatically return to the initial set time.

- If the watch is switched to another mode while Timer is in operation (countdown is in progress or stopped) and then switched to Timer again, the watch will return to initial state of use. If countdown has been completed, the watch will return to the initial set time.

G) Using Race Timer (CAL. C610 only)

- Race Timer can be set to 15 different durations of countdown 60, 55, 50, 45, 40, 35, 30, 25, 20, 15, 10, 6, 5, 3 and 1 minutes. Use this function by setting to one of these countdown lengths as desired.
- When Race Timer countdown is finished, Time-Up signal will sound for 5 seconds and the watch will be automatically switched to Chronograph mode (Auto-Chrono) and start counting from 00 hours 00 minutes 00 seconds.

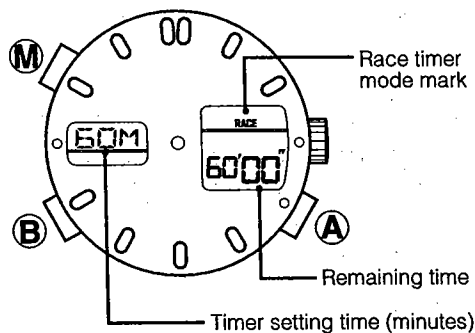

To Set Race Timer

Press **(B)** button in Race Timer mode. Length of time countdown will change 15 times starting from 60 minutes down to 1 minute. Set Race Timer to desired length. Press and hold **(B)** button for rapid advancement.

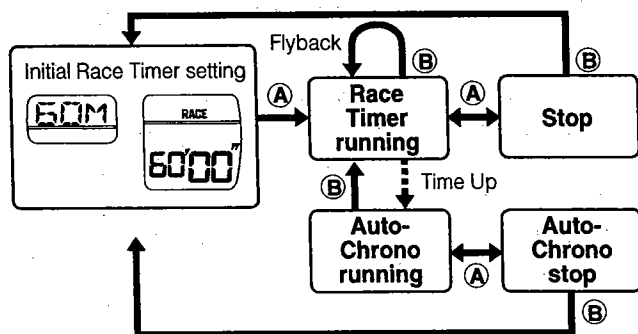

To use Race Timer

- (1) Press **(A)** button in Race Timer mode. Timer starts countdown from the set time.
- (2) Press **(A)** button stop/start countdown.
- (3) Press **(B)** button when countdown is stopped. Race Timer display returns to initial setting.
- (4) If **(B)** button is pressed while countdown is continuing, Race Timer returns to initial setting and auto-matically restarts countdown. (Flyback)
- (5) When Race Timer countdown is finished, Time-Up signal will sound for 5 seconds and the watch will be automatically switched to Chronograph mode (Auto-Chrono) and start counting from 00 hours 00 minutes 00 seconds.

- Buzzer will sound to mark remaining time at 10, 5, 3, 1 minutes and 50, 40, 30, 20, 10, 5, 4, 3, 2, 1 seconds.

Auto-Chrono Measurement

- When Race Timer countdown is finished, Time-Up signal will sound and the watch will be automatically switched to the Chronograph running mode (Auto-Chrono).
- Auto-Chrono will start counting from 00 hours 00 minutes 00 seconds.

Using Auto-Chrono

- (1) To stop Auto-Chrono, press **(A)** button while Auto-Chrono is running. To restart Auto-Chrono, press **(A)** button while Auto-Chrono is stopped.
- (2) To switch to Race Timer running mode, press **(B)** button while Auto-Chrono is running.

Display after switching to Race Time/Auto-Chrono

- * When Race Timer and Auto-Chrono are running, microcomputer in the watch keeps repeating Race-Timer countdown as shown in diagram. If switched to Race Timer from Auto-Chrono, the watch will show Race Timer countdown in progress. (Countdown of microcomputer does not stop even if Auto-Chrono is stopped.)

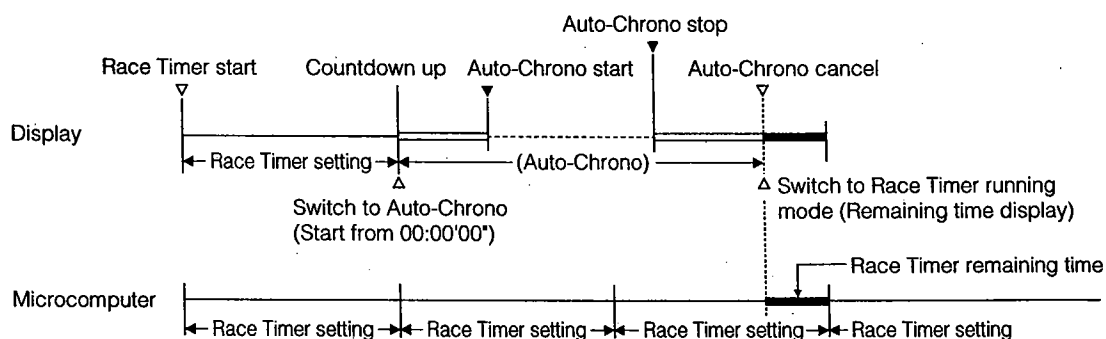

- (3) To return to initial Race Timer setting, press **(B)** button in Auto-Chrono stop mode.

- The watch will return to Time display mode if **(M)** button is pressed in Race Timer or Auto-Chrono mode.
- If switched to another mode from initial Race Timer setting, Race Timer running, Race Timer stop, Auto-Chrono running or Auto-Chrono stop mode and then reset to Race Timer, function will return to the mode set at the time of switching. However, if Auto-Chrono counting has exceeded 24 hours, the watch will return to initial Race Timer setting Mode.

H) Zone Set Mode (CAL. C600 only)

- Using Zone Set function, you can preselect desired Cities from among 24 major cities of the world and easily call up on the watch local time of any of these Cities.

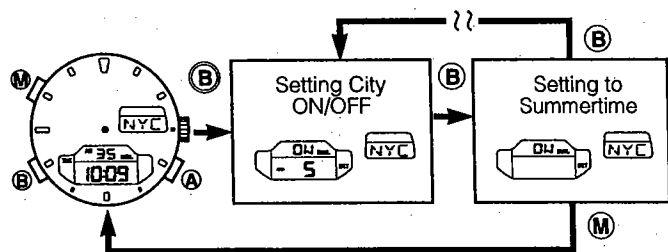
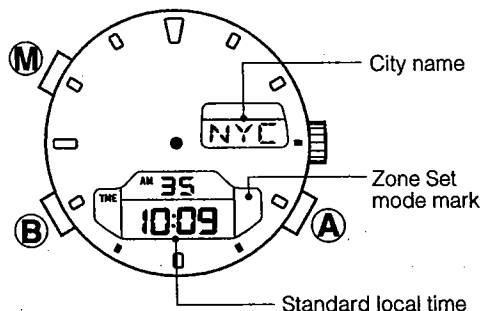

To use Zone Set

- Press **M** button to switch to Zone Set mode.
- Press **A** or **B** button to select desired Cities.
- Press and hold **B** button for more than 2 seconds. "ON" or "OF" and the City name will flash. (When you press **B** button at this time, the name of next City will appear for an instant and then return to the City initially selected.)
- Press **A** button and set each City "ON" or "OF".
- If you press **B** button at this stage, "ON SUM" or "OF SUM" will flash for Summertime setting.
- Press **A** button to set Summertime "ON" or "OF".
- Press **B** button to select next City. Then repeat operations (4) through (6) to set a new City "ON".
- After setting of each city is completed, press **M** button to return to normal Zone Set display.

■ Summertime

- If Summertime is set "ON" in Zone Set mode, display in Time and Alarm modes will be also switched to Summertime and show time one hour later than standard local time.

■ Auto-Return

- If the watch is left in adjustment mode for more than 2 minutes without any operation, it will automatically return to normal Zone Set mode.
- If the watch is kept in Zone Set mode for more than 2 minutes without any operation, it will automatically return to normal Time display.

■ Instant Manual Return

- If you press (M) button in adjustment mode, the watch will return to normal Zone Set mode. At this time, it will shown city name which was on display when the watch was set to adjustment mode. If this city has been preset "OF", the watch will select another city in upward order and show next city which has been preset "ON". If all cities have been preset "OF", it will return to UTC.

■ Switching mode from Zone Set to normal Time display

- If you switch mode from Zone Set to normal Time display and then reset to Zone Set, the watch will show city name which was on display when mode was switched. If you have changed city selection in Time of Calendar mode, newly selected city will be shown in Zone Set mode.

■ City Name Display

- You can set a city "OF" in Zone Set mode after setting this city "ON" in Time, Calendar or Alarm mode. In this case, if the watch is set again to Time, Calendar or Alarm mode, it will select another city in upward order and show next city which has been preset "ON". If all cities have been preset "OF", it will return to UTC.

§12. ALL RESET FUNCTION

Use All Reset function to reset the watch after replacing secondary battery or if the watch is showing abnormal operation or display. All Reset function can be performed as follows:

- (1) Press (A), (B) and (M) buttons simultaneously for more than 2 seconds. All digital displays will disappear. (If any one of the buttons is released, all displays will reappear.)
- (2) Release all 3 buttons. The watch will restart from 12:00 UTC.
- (3) You will hear a beep sound 2 times indicating All Reset is complete.
- (4) Adjust Time, Calendar and other modes to the correct time before use.

[CAL. C600]

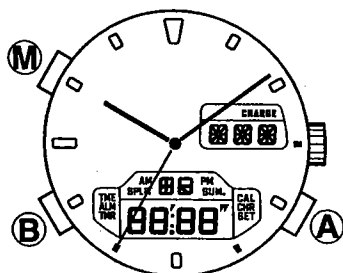

[CAL. C610]

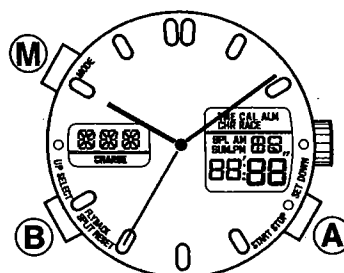

§13. DISASSEMBLY AND ASSEMBLY OF MODULE

Disassembly procedure: ① → ②⑨

Assembly procedure: ②⑨ → ①

● Lubrication mark

- Ⓐ : A-Lube oil
- Ⓥ : V-Lube oil
- Ⓕ : F-Lube oil
- ⓄⓄ : CH-1 oil

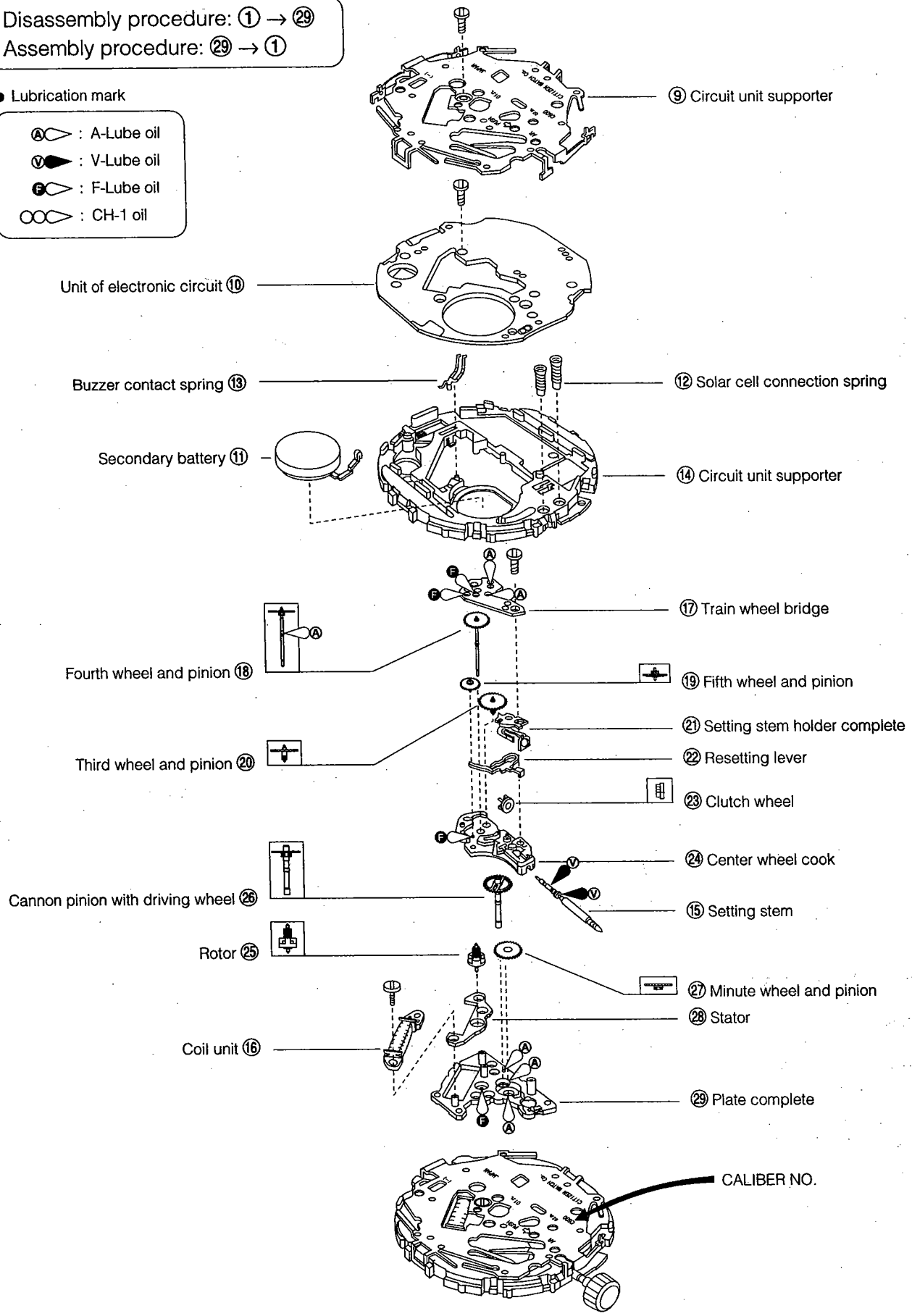

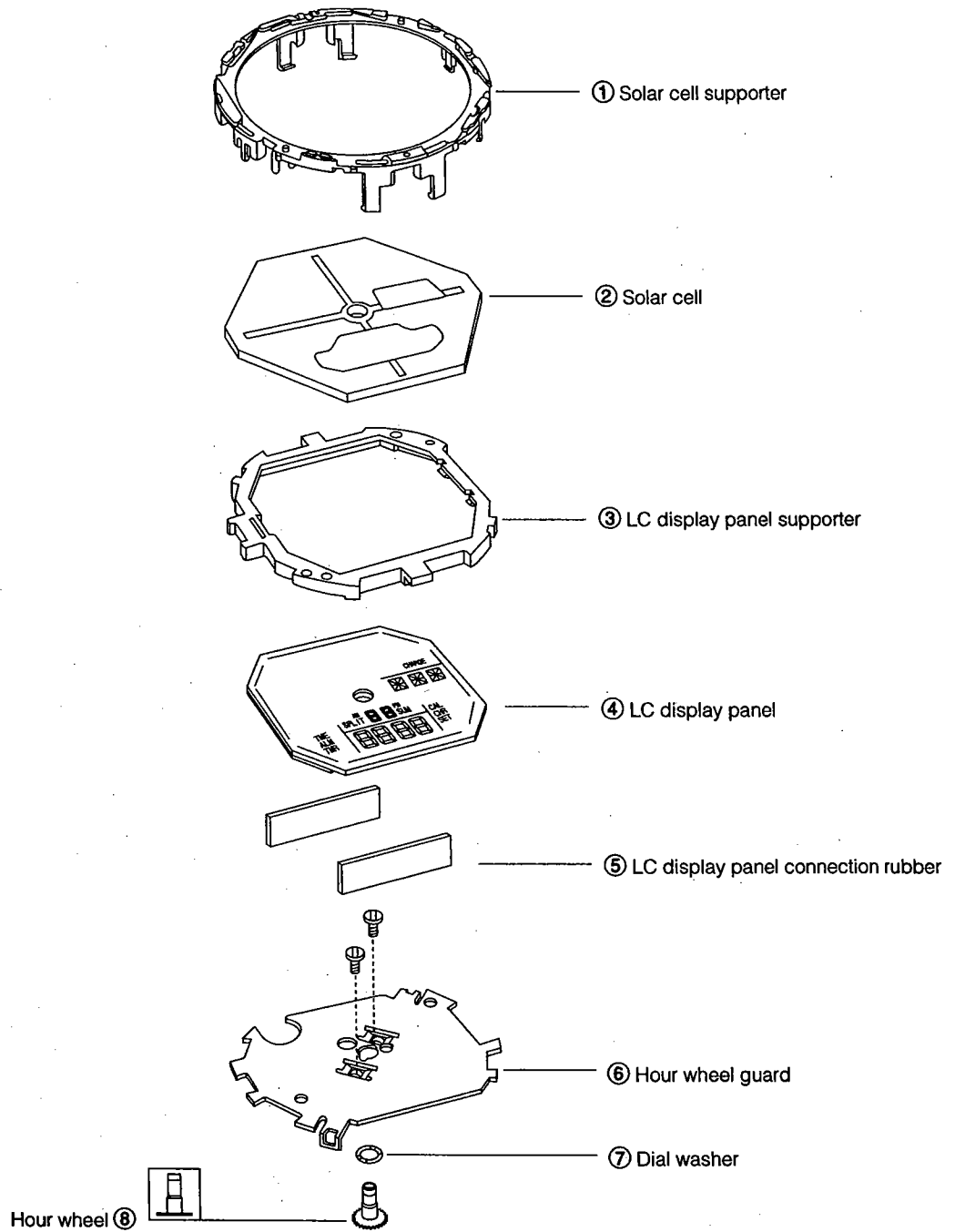

Installation of LC display panel

- ① Fit the LC display panel to the LC display panel supporter, then install them together to the movement.
- ② Take care not to install the LC display panel upside down.

<How to confirm upside>

The two black triangular marks are made on the upside (in the direction of 12 o'clock).

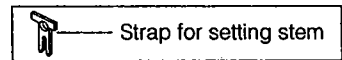
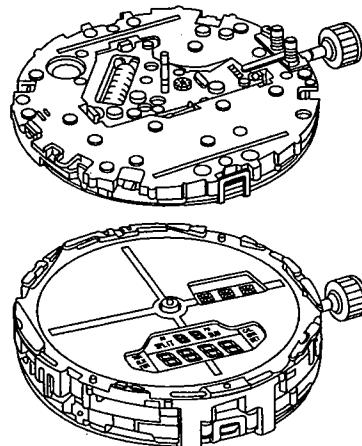
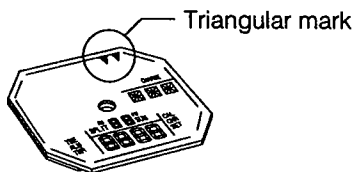

☆ Used for onepiece case.

§14. TROUBLESHOOTING AND ADJUSTMENT

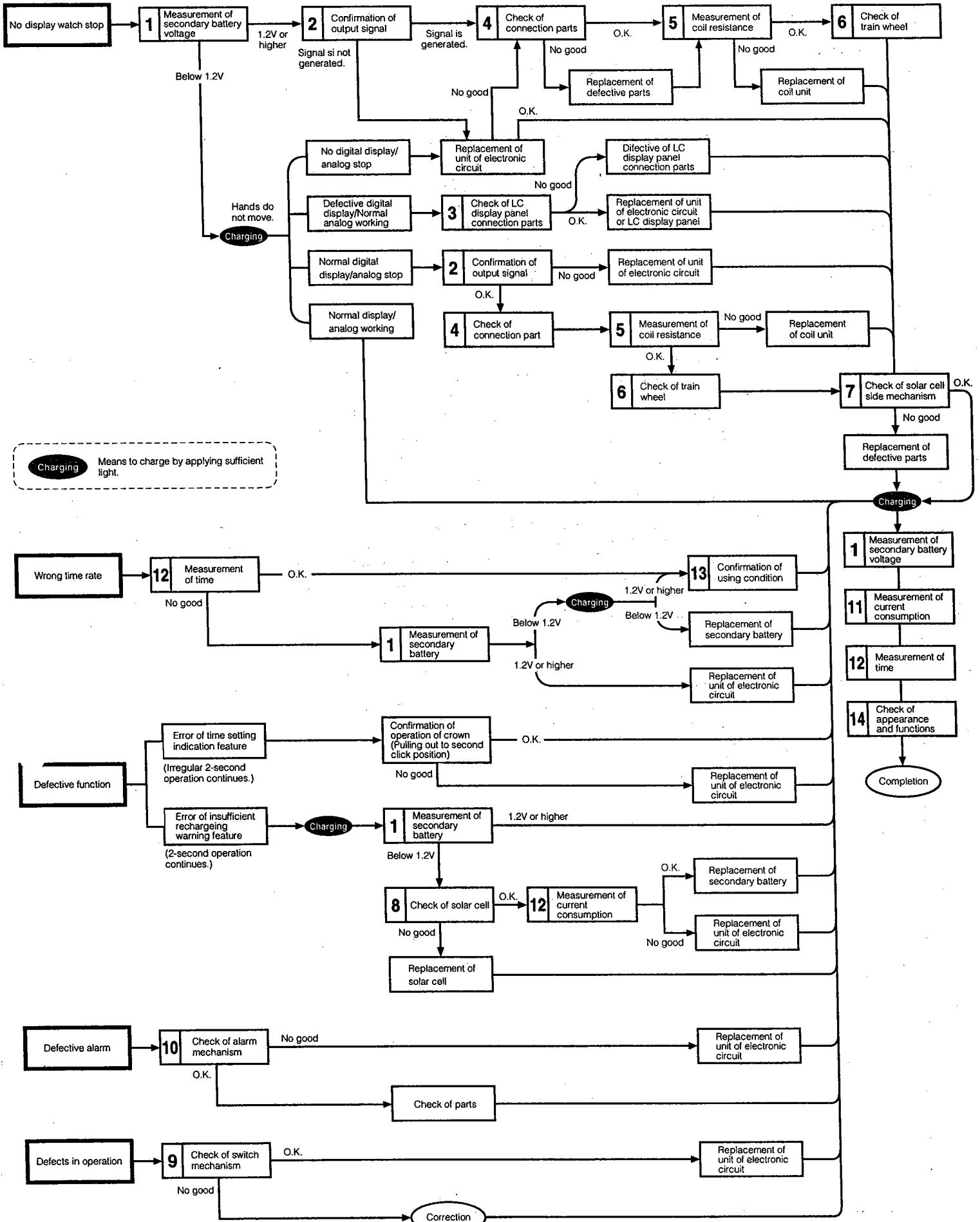

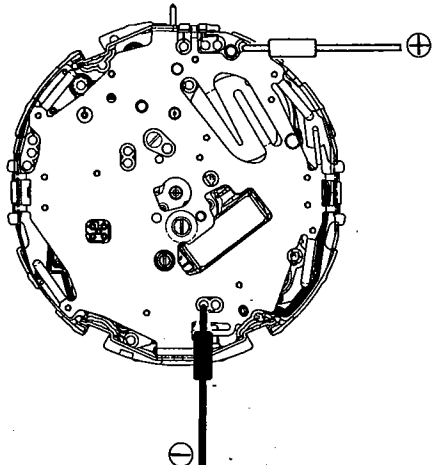
Check Items	How to Check	Result and Treatment
<p>① Measurement of secondary battery voltage</p>	<p style="text-align: right;"><Tester range: DC. 3V></p>  <p>Reference:</p> <ul style="list-style-type: none"> ● 0.9V~1.2V: Two-second step running mode 1.2V~2.6V: One-second step running mode These voltages may vary slightly from watch to watch. ● Irregular two-second step running is a function that signals that the watch has stopped and restarted. This mode will continue until the watch is set to the correct time, irrespective of the voltage. ● A quick-start is activated by the small-capacity tantalum capacitor which has been incorporated in the circuit, in addition to the primary capacitor. After the watch is illuminated (right after it begins running), the secondary battery voltage will display an extremely low value because the secondary battery has not been fully charged. <div style="border: 1px solid black; padding: 5px; margin-top: 10px;"> <p>Caution: When measuring the voltage, be careful not to place the ⊖ tester pin on the secondary battery strap (a short circuit will occur).</p> </div>	

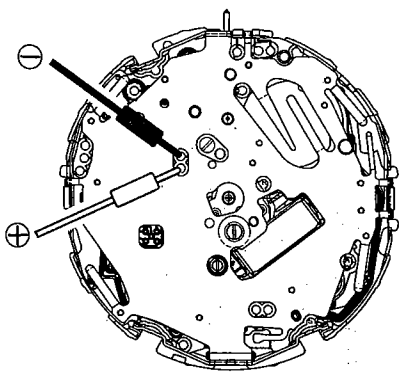
Check Items	How to Check	Result and Treatment
<p>② Confirmation of output signal</p>	<p>[Refer to Technical Manual, Basic Course: II-1-b.] <Tester range: DCV. 0.3V></p>  <p><The tester lead pins have no polarity></p> <ul style="list-style-type: none"> • In the 1-second operation mode, the tester pointer should move to the right left every 1 second. • In the 2-second operation or irregular 2-second operation mode, the test pointer moves in only one direction every 2 seconds. 	<p>Tester pointer does not move → Check connection parts.</p> <p style="text-align: center;">↓</p> <p>Connection parts are normal → Replace of electronic circuit unit.</p>
<p>③ Check of LC display panel connection parts</p>	<p>[Refer to the Digital Section of Technical Manual, Basic Course: II-2-a.]</p> <p>Inspection of all segments</p> <p>(1) Press A, B and M buttons simultaneously for more than 2 seconds. All digital displays will disappear. (If any one of the buttons is released, all displays will reappear.)</p> <p>(2) Release all 3 buttons. The watch will restart from 12:00 UTC. (Refer to §12. ALL RESET FUNCTION)</p> <ul style="list-style-type: none"> • Continuity test on LC display panel, cell connection rubber and plate. Check the parts for stain, breakage, etc. 	<ul style="list-style-type: none"> • LC display panel, connection rubber or metal plate is not installed correctly. → Install correctly. • Parts are stained or dirty. → Remove stain and dirt. • Parts are broken or scratched. → Replace parts.
<p>④ Check of connection parts</p>	<p>[Refer to the Analog Section of Technical Manual, Basic Course: II-2-a.]</p> <ul style="list-style-type: none"> • Check for looseness of screws, dust, stain, etc. • Check for stain and removal of the solar cell pattern (two places), deformation of connection spring, removal of welded lead plate of the secondary battery stain of the circuit pattern, bad contact of each part. 	<p>Stain of solar cell pattern and circuit pattern → Remove stain.</p> <p>Removal of solar cell pattern, removal of circuit pattern, removal of welded lead plate of secondary battery → Replace parts.</p>

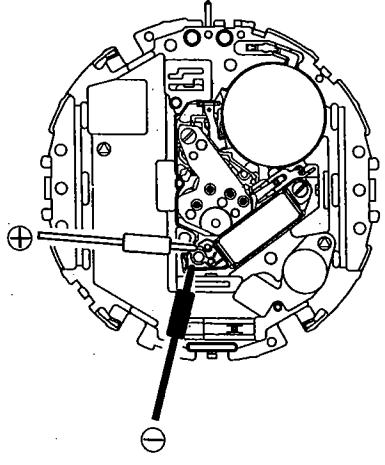
Check Items	How to Check	Result and Treatment
<p>⑤ Measurement of coil resistance</p>	<p>* For the setting method of the tester, see Basic Course: II-1-c.</p> <ul style="list-style-type: none"> Remove the unit of electronic circuit and measure the coil resistance. . <p style="text-align: right;"><Tester range: R x 10Ω></p>  <p style="text-align: center;"><The tester lead pins have no polarity></p>	<p>1.9 ~ 2.3kΩ → Normal</p> <p>Out of range of 1.9 ~ 2.3kΩ → Replace coil unit.</p>
<p>⑥ Check of train wheel</p>	<p>[Refer to Technical Manual, Basic Course: II-2-b.]</p>	
<p>⑦ Check of solar cell side mechanism</p>	<p>[Refer to Technical Manual, Basic Course: II-2-c.]</p>	
<p>⑧ Check of solar cell</p>	<ul style="list-style-type: none"> Check the solar cell for breakage and stain, and check its electrode for stain and flaking. 	<p>Breakage of solar cell → Replace solar cell.</p> <p>Stain → Remove stain.</p> <p>Flaking of electrode → Replace solar cell.</p>

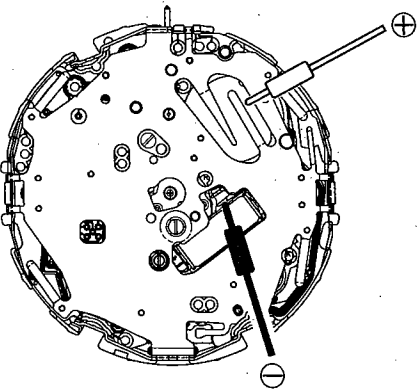
Check Items	How to Check	Result and Treatment
<p>⑨ Check of switch mechanism</p>	<p>1. Inspection of movement.</p> <ul style="list-style-type: none"> • Press the switch spring of circuit unit supporter with tweezers, etc. to contact it to unit of electronic circuit, and confirm the switching function. • Check for removal of pattern of electronic circuit unit, deformation of switch return spring, etc. <p>2. Inspection of push button</p> <ul style="list-style-type: none"> • Check push button for deformation, stain, etc. <div style="border: 1px solid black; padding: 5px; margin-top: 10px;"> <p>Note: Be sure to apply silicone oil to the packing of push button for waterproofness and smooth operation.</p> </div>	<ul style="list-style-type: none"> • Switching function is normal. → Inspect push button. • Pattern is removed or deformed. → Replace defective parts. • Push button is stained or deformed. → Remove stain, or replace push button.
<p>⑩ Check of alarm mechanism</p>	<p>[Refer to Technical Manual, Basic Course: II-1-d.]</p> <p>*1. Set the module in the case, and check output of alarm signal with the case back removed.</p> <p>(1) Set the watch in alarm mode.</p> <p>(2) Apply ⊕ lead pin to circuit unit of supporter and ⊖ lead pin to buzzer contact spring, then press a button.</p> <p style="text-align: right;"><Tester range: DC 0.3V></p> <div style="text-align: center;">  </div> <p>*2. If the output of alarm is normal, perform the following inspection.</p> <ul style="list-style-type: none"> • Check the piezo-electric element of vibrating plate for cracks and breakage. • Check the buzzer contact spring for bend and deformation. • Check the pattern of electronic circuit unit for dust and stain. 	<ul style="list-style-type: none"> • Tester pointer does not swing. → Replace the electronic circuit unit. <p style="text-align: center;">↓</p> <ul style="list-style-type: none"> • Tester pointer swings. → Normal <p style="text-align: center;">↓</p> <ul style="list-style-type: none"> • Perform inspection in *2. <p style="text-align: center;">↓</p> <p>Normal indication. → O.K.</p>

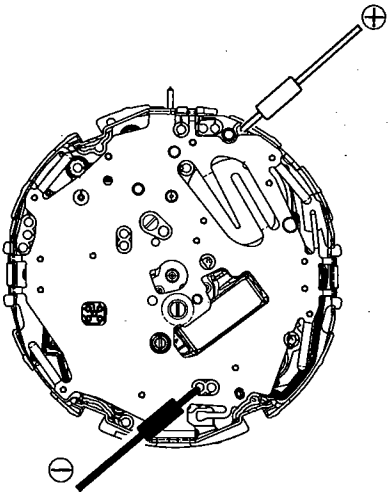
Check Items	How to Check	Result and Treatment
<p>⑪ Measurement of current consumption</p>	<p>[Refer to Technical Manual, Basic Course: II-1-f.]</p> <p>This watch uses a secondary battery block instead of a battery. Accordingly, prepare a silver battery (1.50V or higher), then measure the current consumption according to the following procedure.</p> <ol style="list-style-type: none"> (1) Remove the circuit unit supporter and unit of electronic circuit, then remove the secondary battery block from the movement. (2) Install only the circuit unit supporter and unit of electronic circuit again. (3) Pull out the crown to the first click. (4) Referring to Technical Manual, Basic Course, set the silver battery (1.55V) to the tester adapter. (5) Set the tester. (Apply the test pins ⊕ and ⊖ to the patterns of the electronic circuit unit.) (6) Return the crown to its normal position. (The tester indicates a high value at first. Wait until the tester pointer is stabilized, then start measurement.) <div style="text-align: center;"> <p><Tester range: DC 12μA></p>  </div> <div style="border: 1px solid black; padding: 5px; margin-top: 10px;"> <p>Note: When measuring the current consumption, do not apply any light to the solar cell. If any light is applied, the voltage changes and correct current consumption cannot be measured.</p> </div> <p>★ If the current consumption is measured without shorting the reset terminal to ⊕, the current consumption in the irregular 2-second operation mode is measured, and about 2mA may be indicated.</p>	<p>Current consumption by module</p> <p>Below 3.0μA → Good</p> <p>3.0μA or higher → Measure unit of electronic circuit.</p> <p>Measurement of unit of electronic circuit.</p> <p>Below 1.2μA → Good</p> <p>1.2μA or higher → Replace unit of electronic circuit.</p> <div style="border: 1px solid black; padding: 10px; margin-top: 20px;"> <p>Current consumption by module is high but that by electronic circuit unit is low → A part other than circuit seems to have a trouble. Check for stain, bad lubrication, deformation of parts, and remove causes of load.</p> </div>

Check Items	How to Check	Result and Treatment
<p>⑫ Measurement of time</p>	<p>[Refer to Technical Manual, Basic Course: II-2-d.]</p> <ul style="list-style-type: none"> • Since DF measurement is applied, measure in the 10-second range. The time rate cannot be adjusted, however. The time rate may not be measured accurately in the 2-second operation of irregular 2-second operation. In this case, apply light to the watch until the second hand moves in the 1-second operation mode, then measure the time rate. 	<p>This time gains or loses largely. → Replace the electronic circuit unit.</p>
<p>⑬ Confirmation of using condition</p>	<p>[Refer to Technical Manual, Basic Course: II-2-e.]</p> <ul style="list-style-type: none"> • Since this watch is energized by light, it should receive light as much as possible. If the watch is placed near a light source which generates heat (above 60°C) such as an incandescent lamp, a halogen lamp, etc., its functions and parts may be deteriorated or deformed by the heat. Accordingly, take care when applying light to it. <p>Example: When the watch is hidden under a long sleeve or the customer works in a dark place, it needs to be exposed to light on purpose.</p>	
<p>⑭ Check of appearance and functions</p>	<p>[Refer to Technical Manual, Basic Course: II-2-f.]</p> <ul style="list-style-type: none"> • Check inside of case for dust and stain. • Check operation of setting switches for normality. • Check segment for normality (See 3 Check of LC display panel and connection part.) • Be sure to apply silicone oil to packing of each push button. It is necessary for water resistance and smooth operation. 	