

TECHNICAL INFORMATION

CITIZEN QUARTZ

Cal. No. C130✕

Cal. No. C150✕



[Cal. No. C130]



[Cal. No. C150]

Contents

1	FEATURES	1
2	SPECIFICATIONS	2
3	NAME OF EACH PART	3
4	TYPES OF MODES.....	4
5	HOW TO SET AND USE EACH MODE	5
	1. Time/Calendar Mode	5
	2. Alarm Mode	7
	3. Chronograph Mode	8
	4. Chronograph Memo Mode	10
	5. Timer Mode.....	13
	6. Pace Timer Mode	15
	7. Local Time Mode	18
6	ALL-RESET OPERATION AND ALARM MONITOR	19
7	HANDLING METHOD OF REGISTER RING	20
8	DISASSEMBLE AND ASSEMBLE OF MODULE.....	21
9	INSPECTION AND ADJUSTMENT METHOD OF MODULE	24

1 FEATURES

Cal C130:

This watch is a combination quartz watch made by high technologies, which has proper functions for touring on a bicycle, road racer, etc.

Cal C150:

This watch is developed by eliminating the pace timer function from Cal C130 and modifying it for marine sports.

This watch has the following functions.

- **Analog indication**

Hour, minute, second

- **Digital indication**

Time/Calendar	(TME)
Alarm	(ALM)
Chronograph	(CHR)
Chronograph memo	(CHR MEMO)
Timer	(TMR)
Pace timer	(PACE TMR)...(Cal C150 does not have this function.)
Local time	(L-TM)

2 SPECIFICATIONS

Caliber No.		C130	C150	
Type		Combination quartz watch		
Module size		Ø30.8 x 26.0 x 27.4, 4.9 thick (mm)		
Accuracy		±20 sec/month at normal temperature		
Lifetime of power cell		Approx. 2 year		
Indication methods and functions	Analog	Time:	Hour, minute, second	
	Digital	Time:	Hour, minute, second	
		Calendar:	Month, date, day (Year is indicated in correction mode)	
		Alarm:	Hour, minute, A/P, ON/OFF	
		Chronograph:	Hour, minute, second, 1/100 second	
		Chronograph memo:	Hour, minute, second, 1/100 second Starting time and 10 memos (Time of day, split time)	
		Timer:	Can be set up to 23 hours 59 minutes 59 seconds	
		Pace timer:	Pace maker (60 ~ 180/min, pace sound) Timer	—
	Local time:	Hour, minute (L mark)		
Power cell		280-44 (SR927W) Note that the lifetime of the power cell depends on the using time of the alarm, chronograph, etc.		
Battery	Part No.	280-44		
	Battery code	SR927W		
	Nominal voltage	1.55 V		
	Nominal capacity	55 mAH		
	Lifetime	Approx. 2 years note that the lifetime of the battery depend on the using time of the alarm, chronograph etc.		
Current consumption		within 3.1 µA		
Coil resistance		2.2 kΩ ~ 2.6 kΩ		

<The above specifications are subject to change.>

3 NAME OF EACH PART

(Indication in Time and Calendar mode)

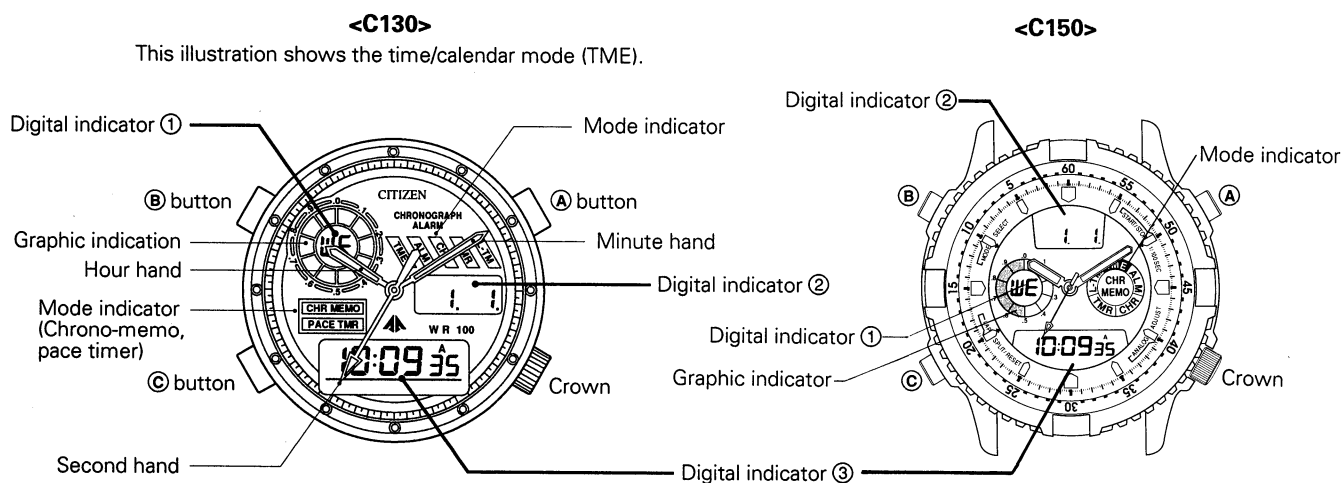

*Some models have register rings.

Table of each mode of digital indicator ①, ② and ③

	Mode	Cal. C130	Cal. C150
Digital indicator ①	Timer/Calendar Alarm Chronograph Chronograph memory Timer Pace timer Local time	Day Day Split time count number Memo number Day Pace timer number 1 or 2 Day	Day Day Day Split time count number Memo number Day — Day
Digital indicator ②	Time/Calendar Alarm Chronograph Chronograph memory Timer Pace timer Local time	Month, date Month, date 1/100 second 1/100 second Month, date Pace (per minute) Month, date	Month, date Month, date 1/100 second 1/100 second Month, date — Month, date
Digital indicator ③	Time/Calendar Alarm Chronograph Chronograph memory Timer Pace timer Local time	Hour, minute, second Alarm time, ON/OFF Chronograph time (Hour, minute, second) Chronograph time (Hour, minute, second) Timer (Hour, Minute, Second) Timer (Hour, Minute, Second) Local time, L mark	Hour, minute, second Alarm time, ON/OFF Chronograph time (Hour, minute, second) Chronograph time (Hour, minute, second) Timer (Hour, Minute, Second) — Local time, L mark

- Specifications of module: Same as C130, except this module does not have the pace timer function.

(Note)

- Cal C150 is developed by eliminating the pace timer function from Cal C130 and modifying the indication layout of the latter.
- Since the basic specifications of Cal C130 and C150 are the same, this Technical Explanation can be used for both of them, although it mainly explains about Cal C130.

4 TYPES OF MODES

The mode changes in the following order every time the **(B)** button is pushed.

★ Change of mode

This illustration shows the normal state in each mode.

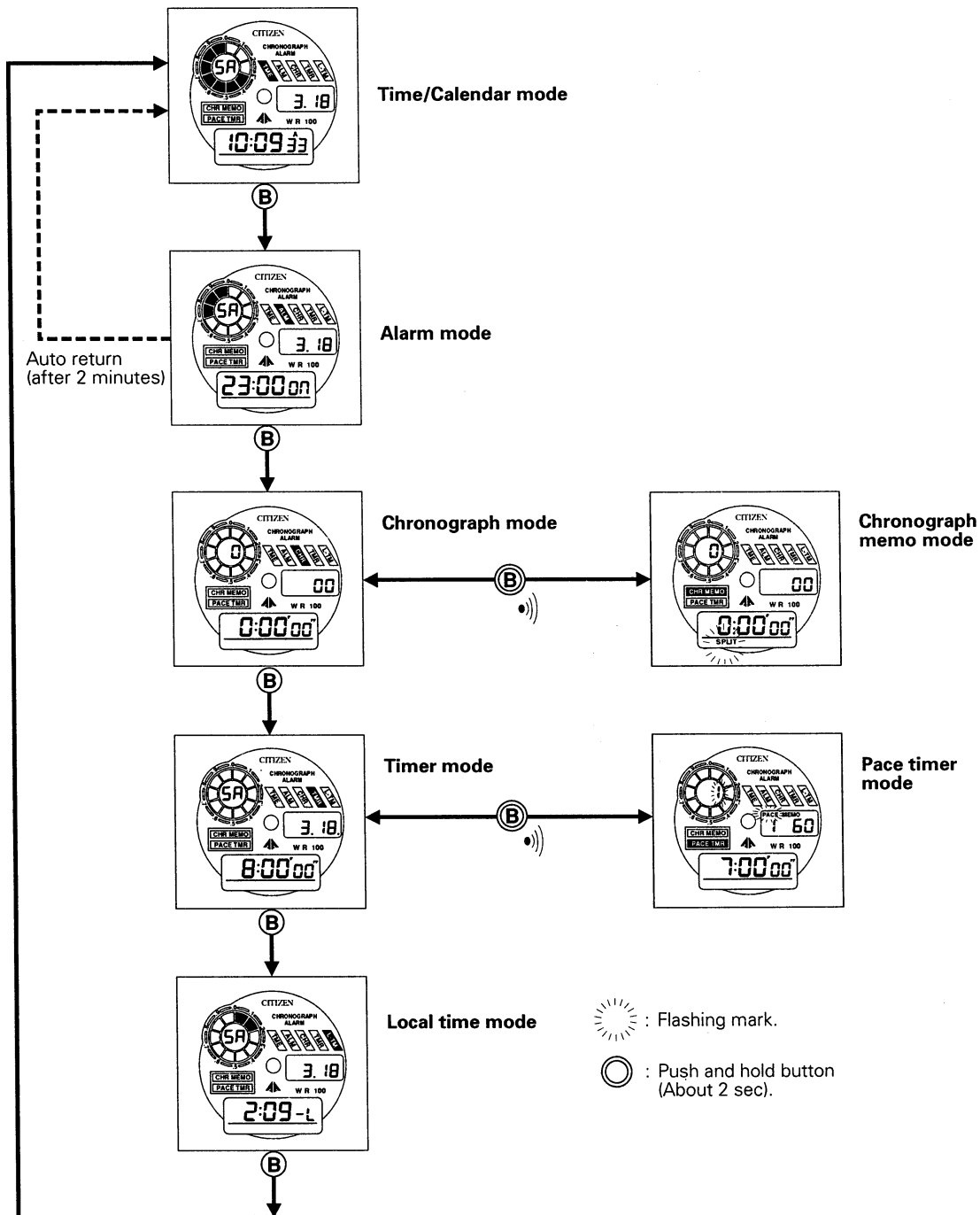

- **Auto-return:** If the normal indication in the alarm mode is continued for about 2 minutes, the watch is automatically returned to the time/calendar mode.
- If the **(B)** button is pushed during the normal indication in the time/calendar mode, alarm mode, or local time mode, the mode changes.

If the **(B)** button is pushed during any indication in the chronograph mode or timer mode, the mode changes. (It does not change, however, while the watch is being corrected.)

5 HOW TO SET AND USE EACH MODE

The analog indication (hour, minute, and second hands) of this watch are set similarly to an ordinary watch. The following is the explanation of the digital indication in each mode.

1. Time/Calendar Mode (TME)

★ How to set time and calendar

<Normal indication of time and calendar>

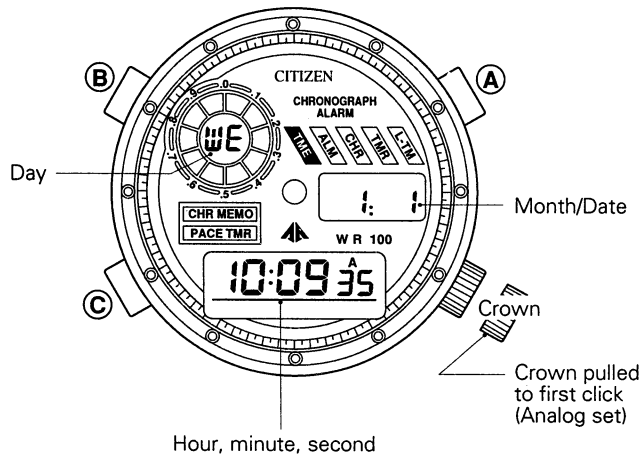

1) Setting of analog section (Setting of hour, minute, and second hands)

Pull the crown to the first click, then turn it to the right or left to set the time.

2) Setting of digital section

While the time and calendar are normally indicated, push and hold the (A) button until the second flashes.

If the second flashes, it can be corrected.

Every time the (A) button is pushed, the flashing point (correction item) moves as shown below. Make the necessary item flash and push the (C) button to correct it. Return the watch to the normal indication mode, and setting is finished.

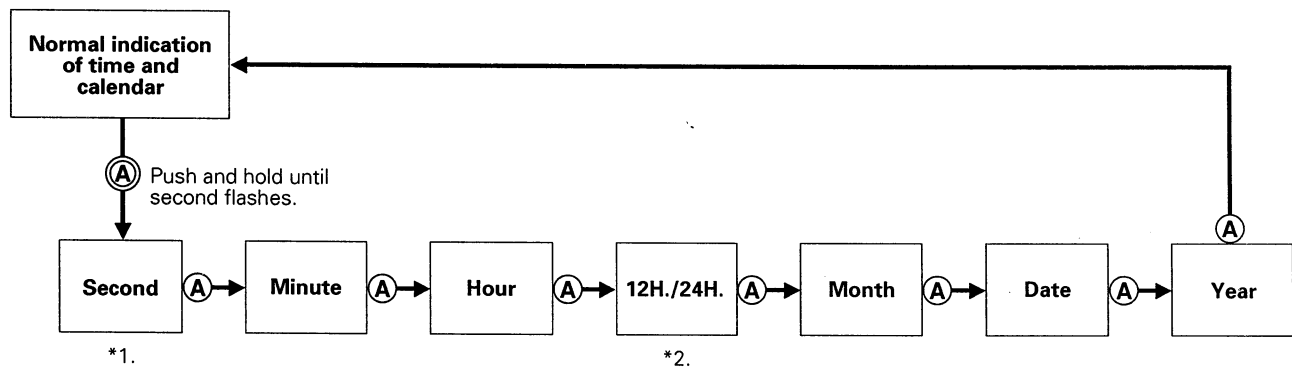

Notes • Graphic indication: Time and calendar are indicated graphically in the second indication timing.

*1 • **Zero second return:** If the (C) button is pushed in the second correction mode, 0 second is indicated. If the second is between 30 seconds and 60 seconds at this time, the watch is advanced by 1 minute.

*2 • **12H/24H changeover:** Every time the (C) button is pushed, the watch is set to 12-hour and 24-hour systems alternately.

★ **Auto-return:** If the watch is kept in correction mode for about 2 minutes, it is automatically returned to the normal indication mode.

★ **Instant manual return:** If the (B) button is pushed in the correction mode, the watch is forcibly returned to the normal indication mode.

• **Interlock with local time:** If the time is corrected, the local time is automatically corrected at the same time.

Example:

MODE →	TME	L-TM
ORIGINAL TIME →	10:09 MANUAL ADJUSTMENT TO	8:09 (WATCH HAS AUTOMATICALLY ADJUSTED TO LOCAL TIME)
NEW TIME →	12:10	10:10

- **Auto calendar:** The calendar automatically changes every month during the period from 1992 to 2007.
- **Auto correction of non-existing date:** If the calendar is set to a non-existing date by mistake, it automatically indicates the first of the next month when returned to the normal indication mode.

(**Example;** Feb 30 → Mar 01)
- **Day indication:** The day is automatically set when the year, month, and date are set.
- ★ **Quick setting:** If the © button is pushed and held, while the watch is in the correction mode (flashing), the correction item changes quickly. If the © button is released, quick change stops.

Common precautions

The items marked with ★ are common to the all modes.

- ★ **Auto-return:** If the watch is kept in correction mode for about 2 minutes, it is automatically returned to the normal indication mode.
- ★ **Instant manual return:** If the Ⓑ button is pushed in the correction mode, the watch is forcedly returned to the normal indication mode.
- ★ **Quick setting:** If the © button is pushed and held, while the watch is in the correction mode (flashing), the correction item changes quickly. If the © button is released, quick change stops.

2. Alarm Mode (ALM)

★ How to set the alarm

- Similarly to setting of time and calendar, make the correction item flash with the (A) button, then set the alarm to a desired time with the (C) button.
- After the alarm time is set, push the (A) button to return to the normal indication of the alarm, and setting is completed.

(Take care not to mistake AM and PM or 12-hour system and 24-hour system for each other.)

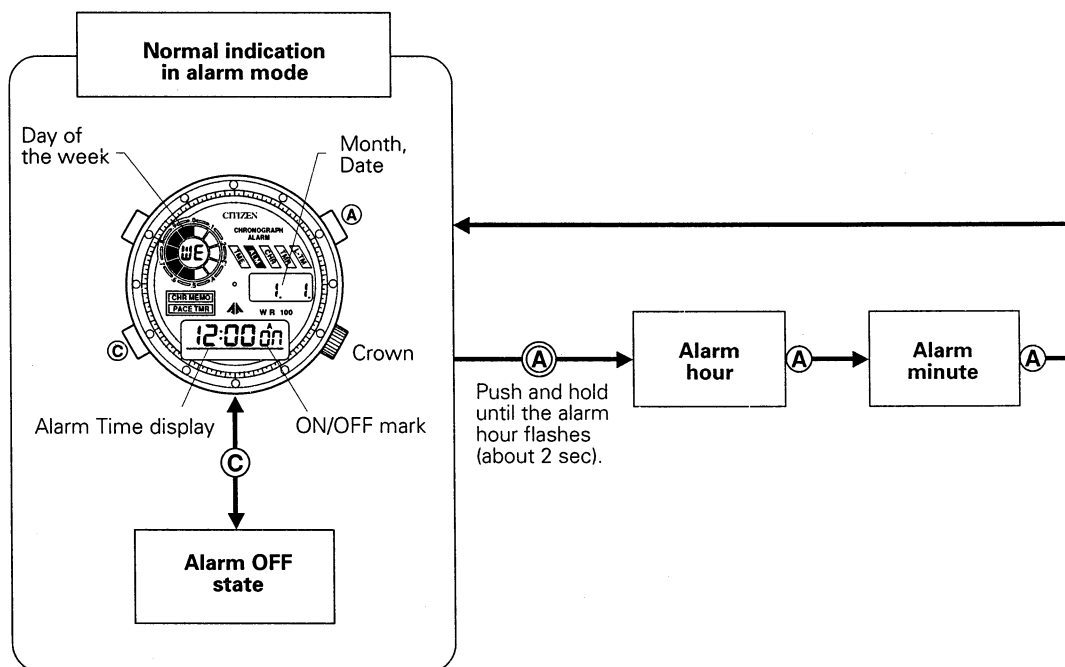

Notes • **12-hour and 24-hour systems:** Matched to the system of time/calendar mode.

- **Alarm ON/OFF:** Every time the (C) button is pushed in the normal indication mode of alarm, the alarm is turned on and off.
- **Sounding length and stopping of alarm:** The alarm sounds for 20 seconds. If any one of the (A), (B), and (C) buttons is pushed while the alarm is sounding, the alarm stops. (The alarm can be also stopped by pulling out the crown.)

3. Chronograph Mode (CHR)

★ How to use the chronograph

- Start and stop the chronograph with the (A) button. If the (C) button is pushed while the watch is measuring, a split time is indicated for about 10 seconds.
- If the (C) button is pushed again while the split time is indicated, the next split time is added. (With a split counter)

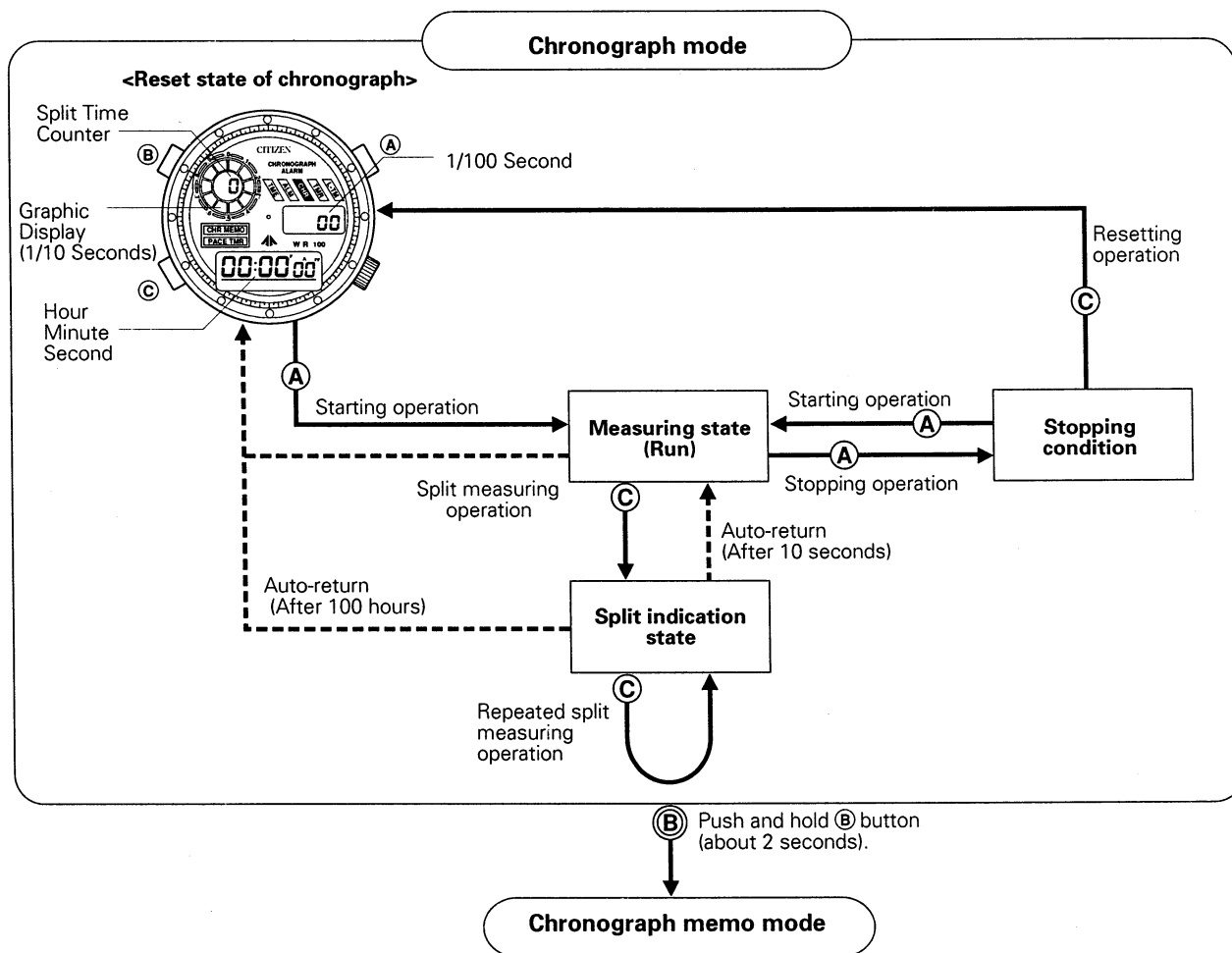

Notes • **Measurement range:** Can measure 0 hour 00 minute 00 second 00 ~ 99 hours 59 minutes 59 seconds 99. Reset if the measured time exceeds 100 hours.

- **Auto-return:**
 - 1) If the split time is indicated for 10 seconds, the chronograph automatically returns to the measurement mode (running state).
 - 2) If the time passes 100 hours in the measurement mode (running state) or in the split time mode, the chronograph is automatically reset to 0 hour 00 minutes 00 second 00.

• **How to use the split counter**

This function is convenient when checking how long did it take from the start point to the target point.

- a) Every time the start operation or split operation is executed, the counter counts 1. The split counter can count up to split No. 99.
- b) In the split measurement mode, the previous count is indicated while the split time is indicated. If the chronograph is set to the running state or if the split time is measured again, the counter counts 1.

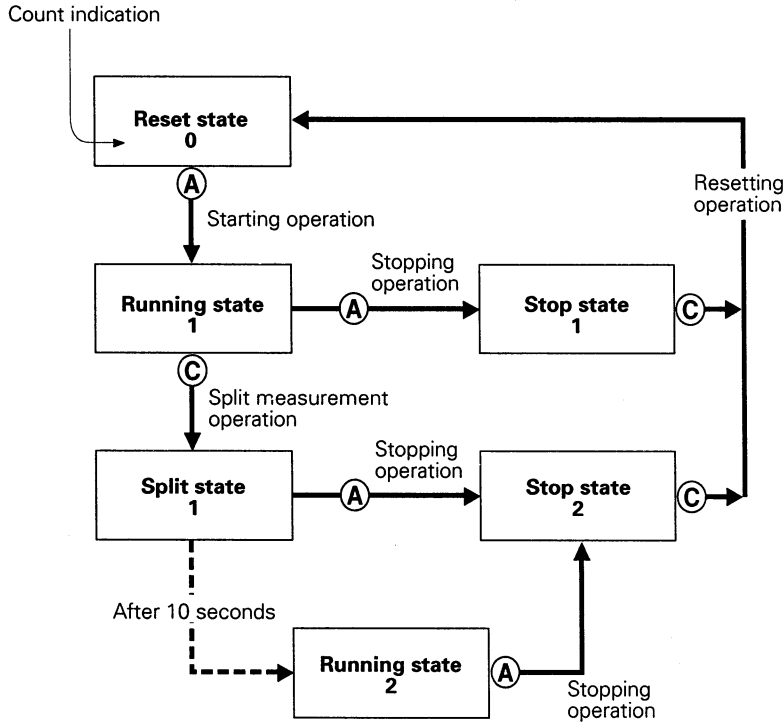

- ◀ In the reset condition
 - The counter indicates 0.
- ◀ At starting operation
 - The counter indicates +1.
- ◀ At stopping operation
 - The counter does not change.
- ◀ At split operation
 - The counter does not change until to the running state.
 - If change to the running state or stopping operation is performed, the counter indicates +1.

Notes • **Split counter:** Repeats 0 ~ 99 times.

- **Split time:** Time taken after starting point.

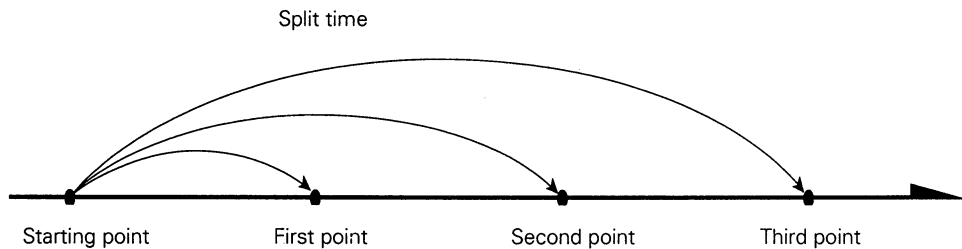

- **Lap time:** Time taken to cover one section.

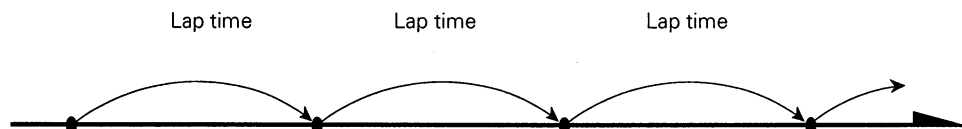

4. Chronograph Memo Mode (CHR MEMO)

With this function, up to 10 split times or lap times can be recorded to check them with the target time.

★ Change to chronograph memo mode

If the **(B)** button is pushed and held for about 2 seconds in the chronograph mode, the watch is set to the chronograph memo mode. At this time, a confirmation sound comes out.

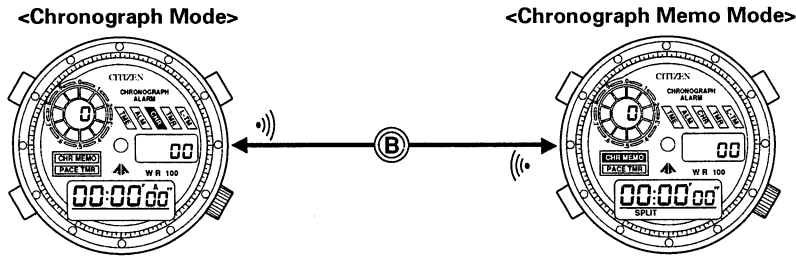

If the **(B)** button is pushed and held again for about 2 seconds, the watch is returned to the chronograph mode.

★ Functions used in chronograph memo mode

- Split chronograph function
- Lap chronograph function

These two functions are available. If the watch is changed from the chronograph mode to the chronograph memo mode, it is always set to the split indication state.

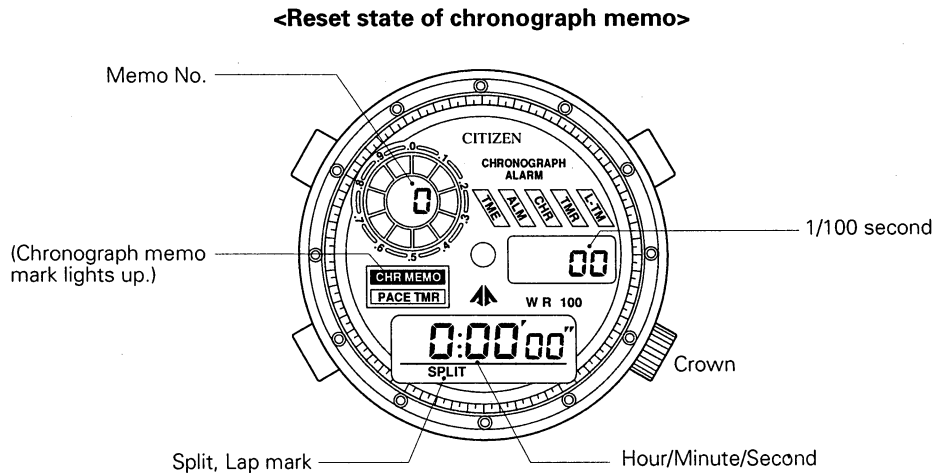

★ How to use the chronograph memo mode

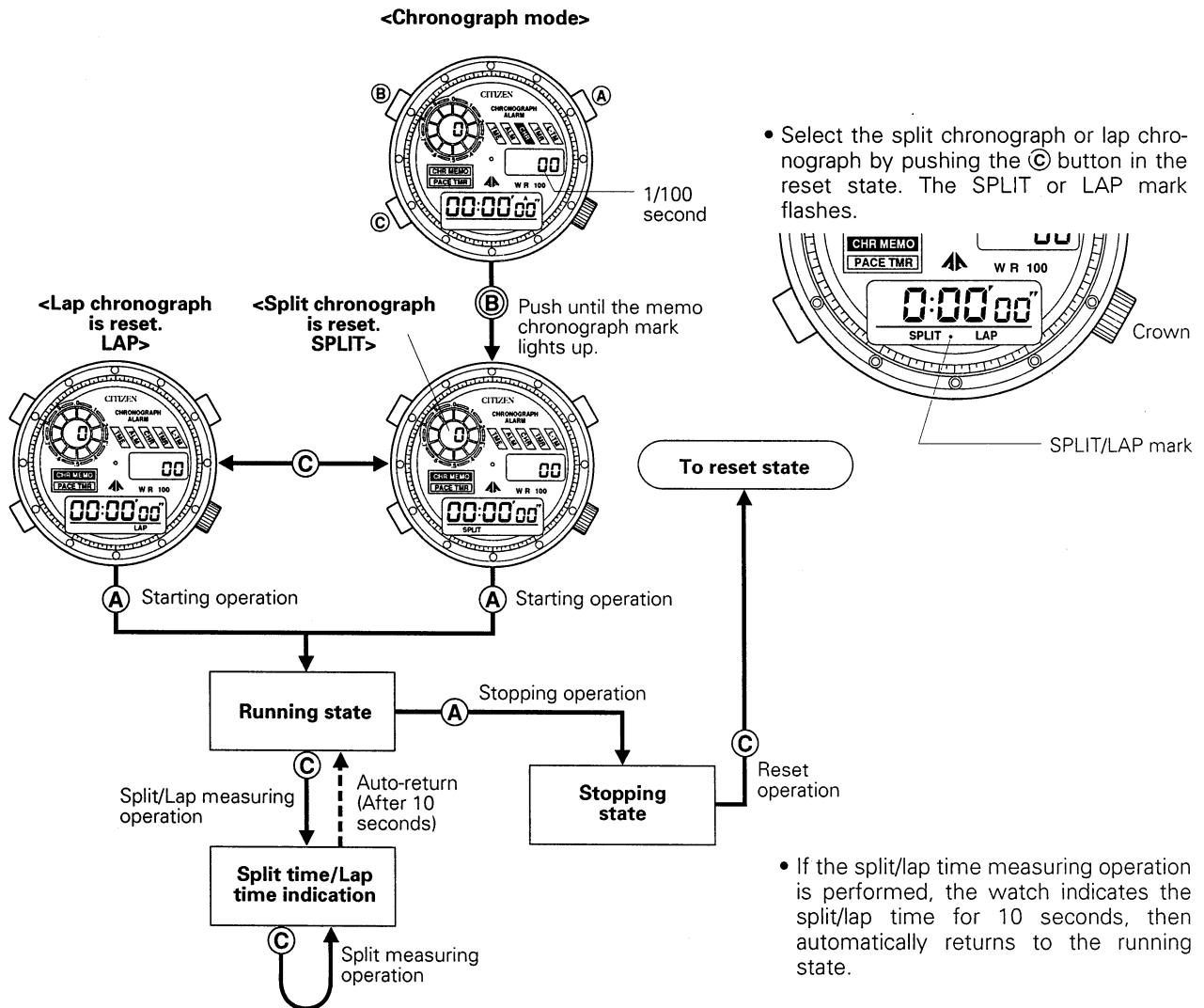

Notes • **Measuring range:** Up to 99 hours 59 minutes 59 seconds 99.

• **Memo:**

- The memo No. is increased by one every time the split measuring operation, lap measuring operation, starting operation, or stopping operation is performed.

(No. 0 does not change, however, when the starting operation is performed in the reset state.)

- The time, split time, or lap time is stored every time the above operation is performed, and it can be called back.
- Up to 11 memos (Memo No. 0 ~ No. 10) can be stored. Only the starting time can be stored as the memo No. 0.
- **Memo No.:**
 - Memo No. of 0 ~ 99 are repeated. The measured data of No. 11 ~ No. 99 can be indicated measuring time during 10 seconds operation, but cannot be stored.
- **Confirmation sound:** Every time the (A) or (C) button is pushed, the confirmation sound comes out.

★ Calling the memos

After the data are measured and the watch chronograph is reset, push the **(B)** button, and the MEMO mark lights up. At this time, if **(A)** or **(C)** button is pushed, the memo No., times of measurement, and measured times appear in order.

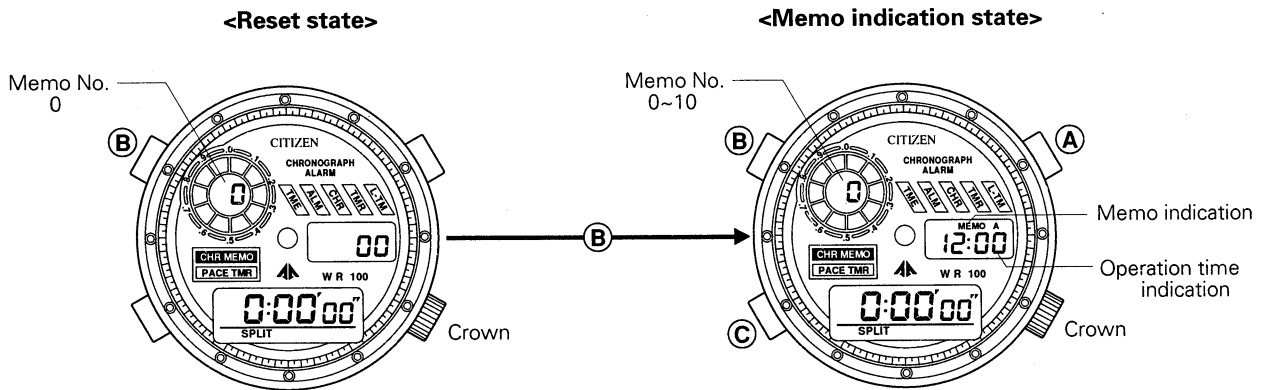

The stored memos can be checked even while the watch is measuring by the following method; Push the **(B)** button to light up the MEMO mark. Push the **(A)** and **(C)** buttons to call the stored memos. If the **(B)** button is pushed, the watch starts measurement again.

- If no data have been stored, the following indication appears.
Only the memo No. appears.

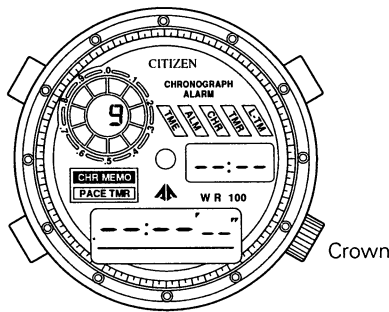

★ Deletion of MEMO

- While the memo is indicated, if the **(A)** and **(C)** buttons are pushed at the same time and held for about 2 seconds, the memo is deleted. At this time, the confirmation sound comes out. The time at the starting point (Memo No. 0) is not deleted, however.
- If the watch is changed from the memo chronograph mode to another mode, all the memos are deleted.
- If the chronograph memo mode is started in the reset state, all the memo stored before are deleted.

5. Timer Mode (TMR)

★ How to set the timer

- Set the timer similarly to the time/calendar.

Push the (A) button to make the correction item flash, then correct it with the (C) button.

- If the (C) button is pushed and held, the timer moves quickly.

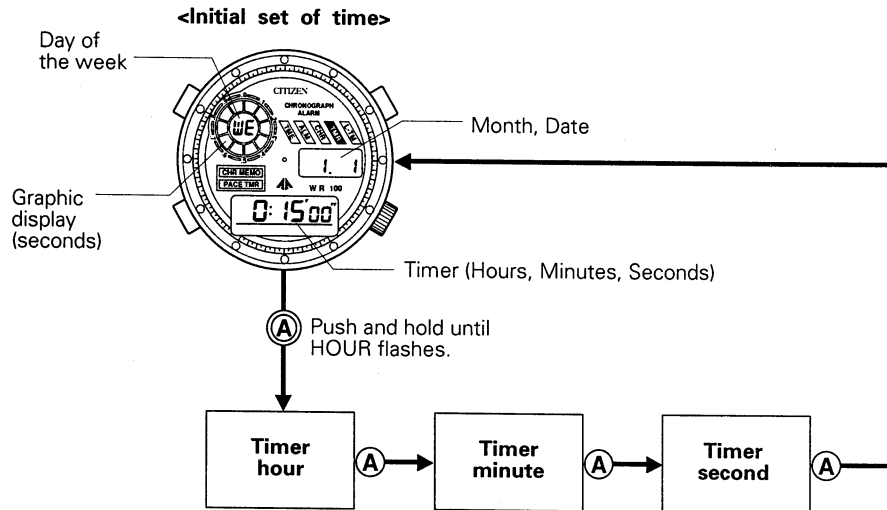

Notes • **Setting range of timer:** 23 hours 59 minutes 59 seconds ~ 1 second

- **Graphic indication:** Left time is indicated graphically.

★ **Auto-return:** If the timer is kept in the correction mode for about 2 minutes, the watch is automatically returned to the initial set condition of the timer.

★ How to operate the timer

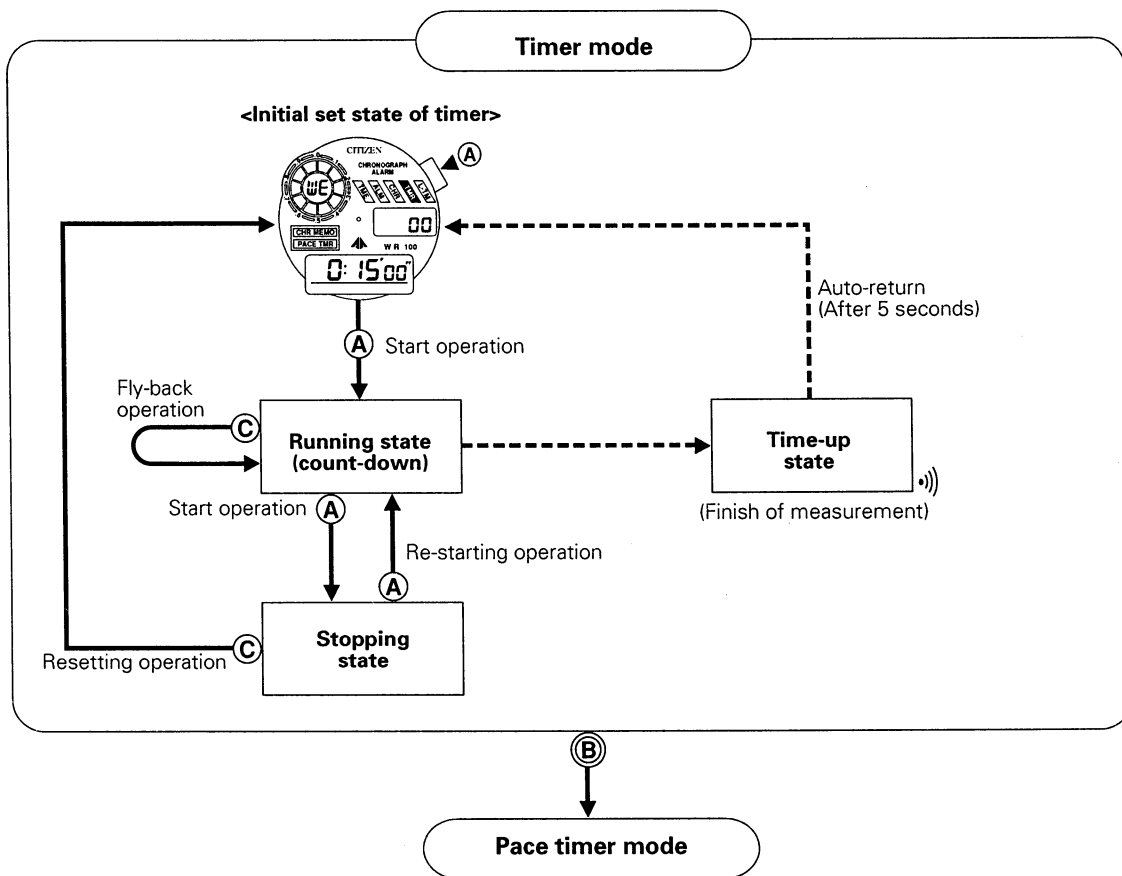

(Note)
Cal C150 does not
have this mode.

Notes • Start and stop the timer with the (A) button.

- If measurement is finished (time-up), the time-up sound comes out for 5 seconds. Then, the timer automatically returns to the initial set state.
- If any one of the (A), (B), and (C) buttons is pushed while the measurement finish sound (time-up sound) is coming out, the sound stops.

At the same time the sound stops, the timer is set to the initial set state.

- **Fly-back operation:** If the (C) button is pushed while the timer is in the running state, the timer returns to the initial set state, then starts again.
- **Operation confirmation sound:** The confirmation sound comes out every time the starting, stopping, fly-back, or resetting operation is performed.
- The timer mode is changed to another mode by pushing the (B) button.

Even if the timer mode is changed to another mode in the running state, the running state is maintained.

If the timer is changed to the pace timer mode or chronograph memo mode, however, the timer turns off the running state and returns to its initial state.

6. Pace Timer Mode (PACE TMR)

In this mode, the pace sound function and timer function are available.
Cal C150 does not have this mode.

★ How to set the pace timer

Push and hold the (B) button for about 2 seconds in the timer mode to set the watch to the pace timer mode.

PACE mark: Flashes only when pace sound is turned on. (Sounding is turned on and off with the (B) button.)

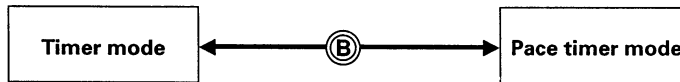

The timer mode and the pace timer mode are changed to each other by pushing and holding the (B) button for about 2 seconds.

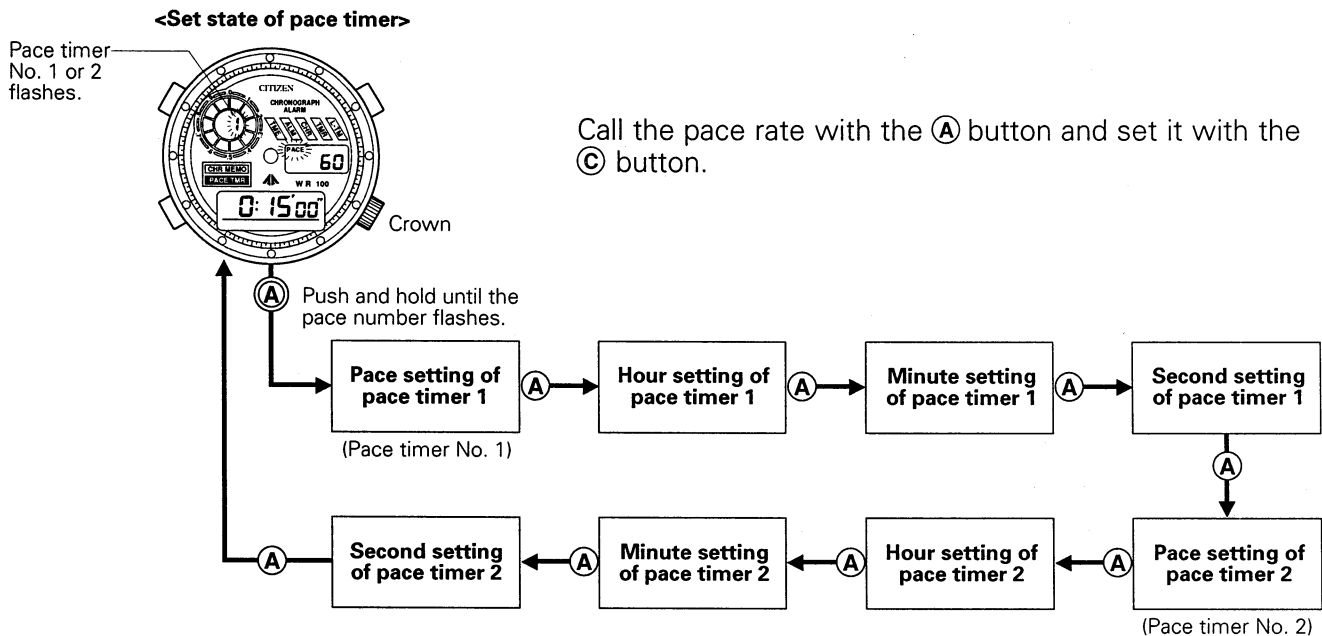

Notes • Pace sound: Number of sounding times in 1 minute.

- **Set range of pace:** 60 ~ 180/min for both pace 1 and pace 2.
The pace is heightened by pushing the (C) button and lowered by holding the (C) button down and pushing the (B) button.
- **Setting range of pace timer:** 23 hours 59 minutes 59 seconds ~ 00 second
- After the pace timer is set, if the (C) button is pushed, the pace timers 1 and 2 are selected alternately.
- The pace rate, timer hour, timer minute, and timer second of either of the pace timers can be set with the (C) button by changing the pace timer 1 and 2 mode.
- If the (A) button is pushed and held for about 2 seconds while setting the pace timer, the watch is forcibly returned to the set state of the pace timer.

★ How to use pace timer

If the pace timers of two types (Pace and Timer) which have the pace sounding function and timer function are used alternately, this watch is effective for exercise of various athletic sports, including bicycle race.

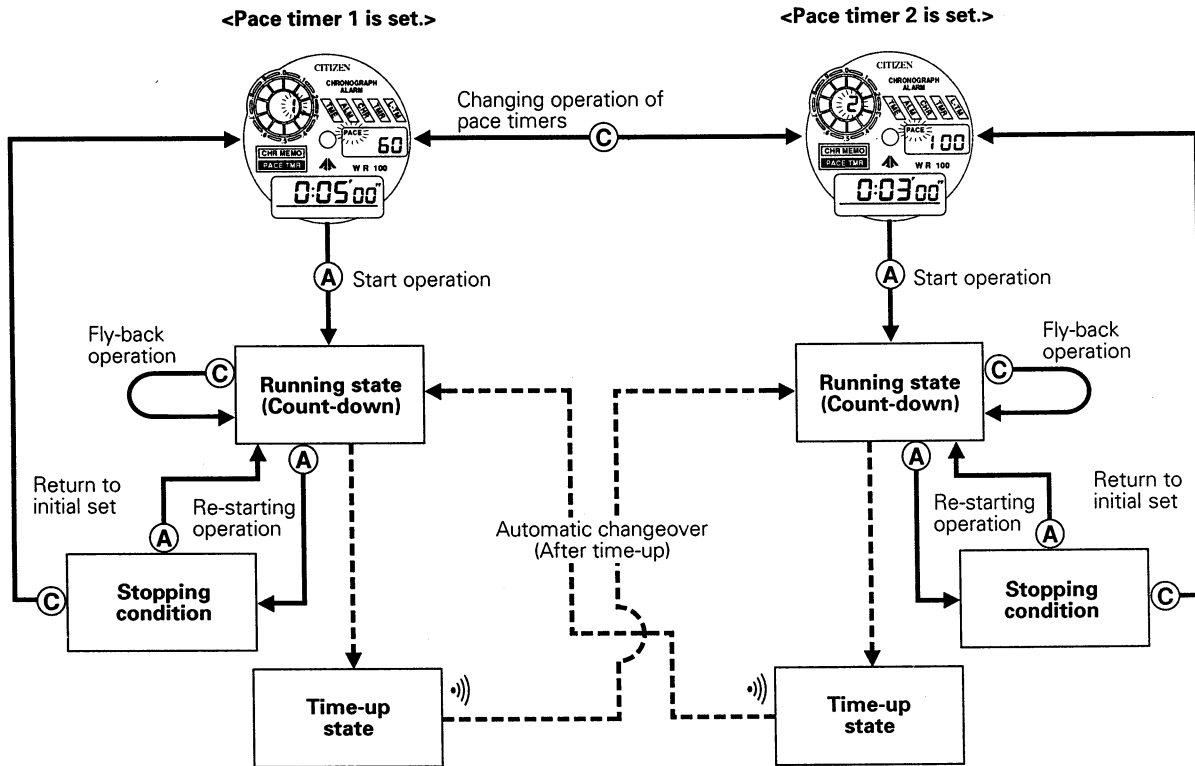

The pace timer is used when the user wants to perform a job at a constant pace (to the sound of the watch) for a certain time. Two pace timers can be used simultaneously. The pace timers 1 and 2 can be used alternately after they are started until stopped.

- Notes**
- **Pace sound ON/OFF:** The pace sound is turned on and off by pushing the (B) button when the pace timer is set, in the running state, or in the pace setting state.
 - **Selection of pace timer 1 or 2:** The pace timer 1 or 2 can be selected with the (C) button when they are set.
 - **Time-up sound:** When timer is up, the confirmation sound comes out for 5 seconds.
 - **Automatic changeover between pace timers:** If either pace timer is up, the other one is automatically set to the running condition (count-down). This operation is repeated.
 - If either timer is not set (0:0'00"), it is not started, but the other one is started repeatedly.

(Example)

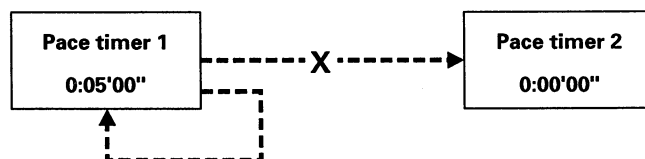

At this example, the operation cannot be started from the pace timer 2. The operation is started with the pace timer 1, and it will be repeated.

★ How to use the pace timer — Concrete example

Example: Set pace timer 1 to 60 times/min, 0:05'00".

Set pace timer 2 to 100 times/min, 0:03'00".

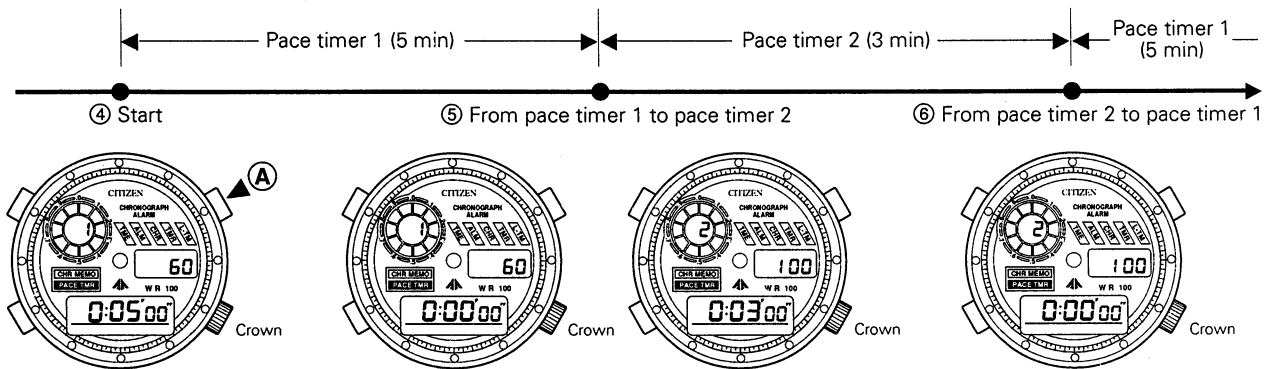

- ① First, set the pace timer 1. Then, set the pace timer 2.
- ② After both timers are set, push the **Ⓒ** button to select the pace timer 1 or 2 which will start first.
- ③ Push the **Ⓑ** button to turn on or off the pace sound.
- ④ After the timers are ready to start, push the **Ⓐ** button to start.
- ⑤ When the pace timer 1 (5 min) is up, the pace timer 2 automatically starts (3 min).
- ⑥ If the pace timer 2 is up, the pace timer 1 starts automatically. This operation will be repeated.

Notes • The pace sound is turned on and off with the **Ⓑ** button.

- The pace timer 1 and pace timer 2 are selected with the **Ⓒ** button in the normal state. Either one can start first.
- If either pace timer 1 or 2 is up, the alarm sounds for 5 seconds.
- The time-up sound can be turned off by pushing any button.
- When returning to the initial set state of the pace timers while the time-up sound is coming out, push any button to stop the sound, then push the **Ⓐ** button to stop the timer. Push the **Ⓒ** button to return to the initial set state.

7. Local Time Mode (L-TM)

★ How to use the local time

The time and calendar mode is used for the home time, and the local time can be used to indicated the local time when traveling overseas countries.

★ How to set the local time

- Set the local time similarly to the time and calendar.

Push the (A) button to make the correction item flash, then correct it with the (C) button.

- If the (C) button is pushed and held, the corrected item changes quickly.

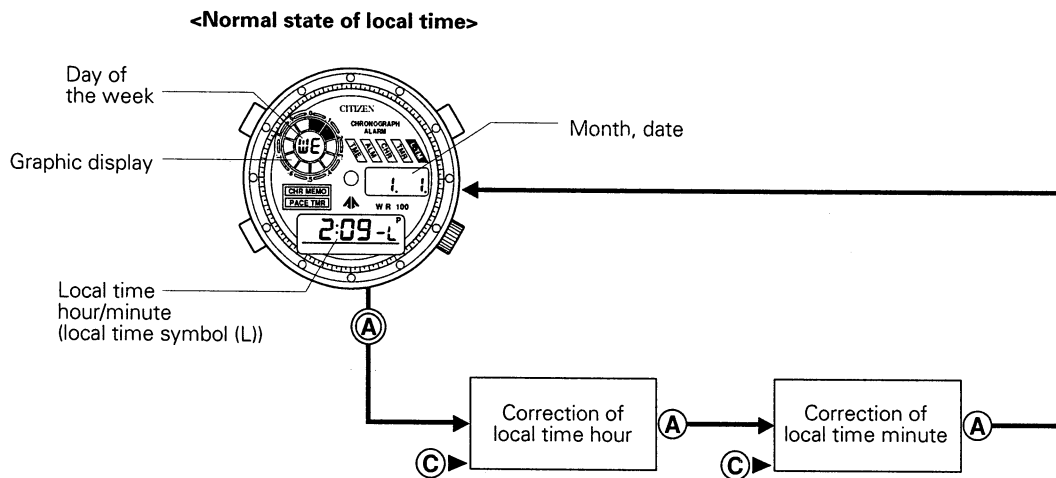

Notes • Only the local time hour and minute can be set.

The indicated month, date, and day are those for the time calendar mode (home time).

- The local time minute can be changed by 30 minutes so that the time difference can be adjusted easily.
- If the time and calendar of the time/calendar mode are corrected, the local time hour and minute are automatically corrected at the same time.

6 ALL-RESET OPERATION AND ALARM MONITOR

(All-reset operation)

After the power cell is replaced or the watch indicates time irregularly, perform the all-reset operation according to the following procedure.

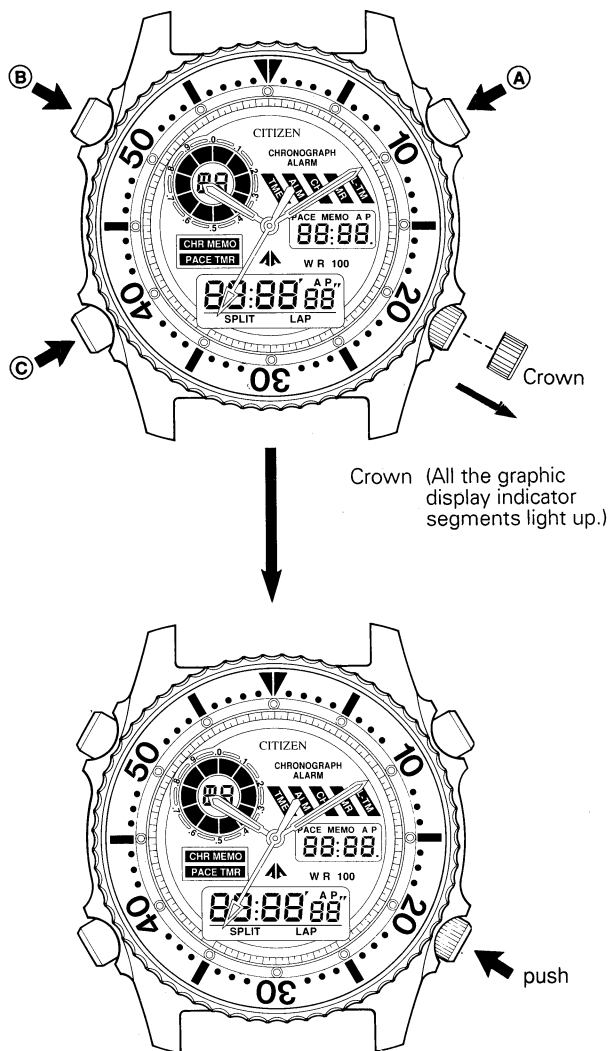

- ① Pull the crown to the first click.
- ② Push the (A), (B), and (C) buttons at the same time.
- ③ Release the (A), (B), and (C) buttons.
At this time, all the digital parts light up.
- ④ Push in the crown.
At this time, the confirmation sound comes out to notify that all-reset is completed.

After the above operation, set the watch correctly.

(Alarm monitor)

The alarm sound of watch can be confirmed by the following procedure.

- ① Push the (B) button to set the watch to the alarm mode.
- ② The sound comes out while the (C) button is pushed and held.

7 HANDLING METHOD OF REGISTER RING

- The register ring can be used in the two different ways during diving, one is to use it as a reference for the time elapsed and the other is to use it as a reference for the time remaining with respect to the preliminary determined period of time.

<Measuring the time elapsed>

- Set the zero (0) (marked by ▼▼) of the register ring to the minute hand. The scale on the register ring will inform you of the period of time passed after the initial setting.

<Example>

1. Let us suppose that it is 10:10.
Now, set the zero (0) (marked by ▼▼) of the register ring to the position of minute hand showing the minutes past 10.
2. After a certain period of time, the time is checked against the watch. It is 10:40.
The scale of the register ring tells you that 30 minutes have passed after the initial setting. (See Fig. 1)

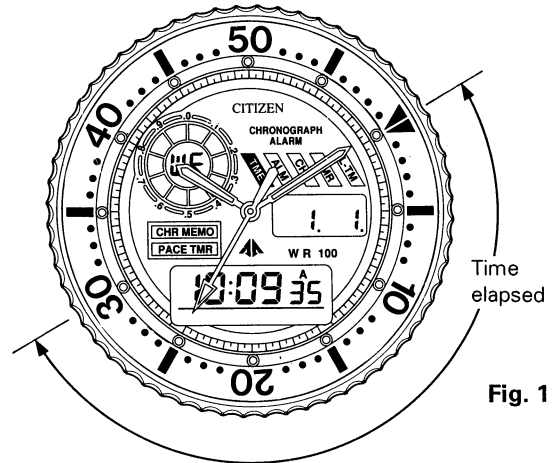

<Measuring the remaining period of time>

- If the zero (0) (marked by ▼▼) of the register ring is set to the target time, the remaining period of time with respect to the target time can be measured on the scale of the register ring.

<Example>

1. Let us suppose that the target time is 10:25.
Set the zero (0) (marked by ▼▼) of the register ring to the position where the minute hand will reach at 10:25.
2. Now, it is 10:10. The scale of the register ring tells you that you have 15 minutes to go until the target time of 10:25 is reached. (See Fig. 2.)

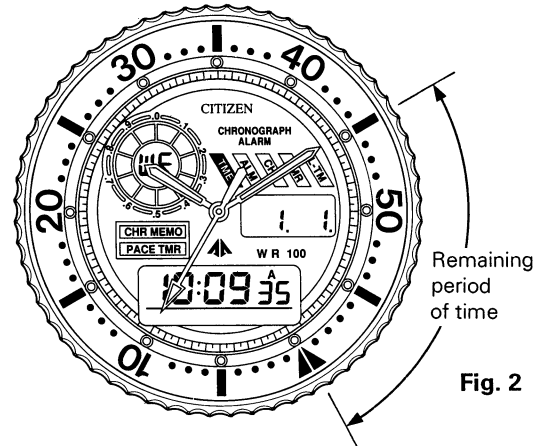

8 DISASSEMBLE AND ASSEMBLE OF MODULE (Same as CAL C150)

Disassemble the parts in order of ① ~ ③⑥
Assemble the parts in order of ③⑥ ~ ①

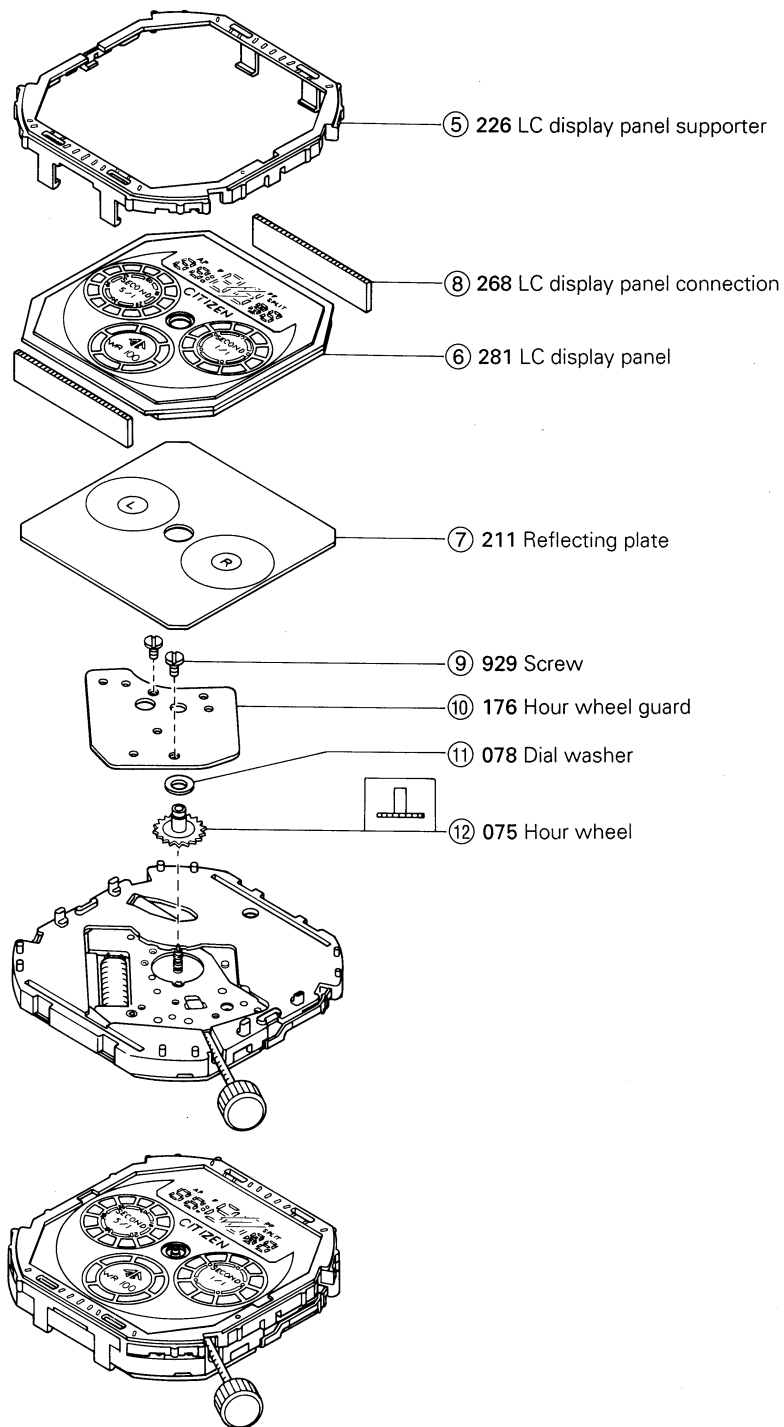

• Lubrication marks

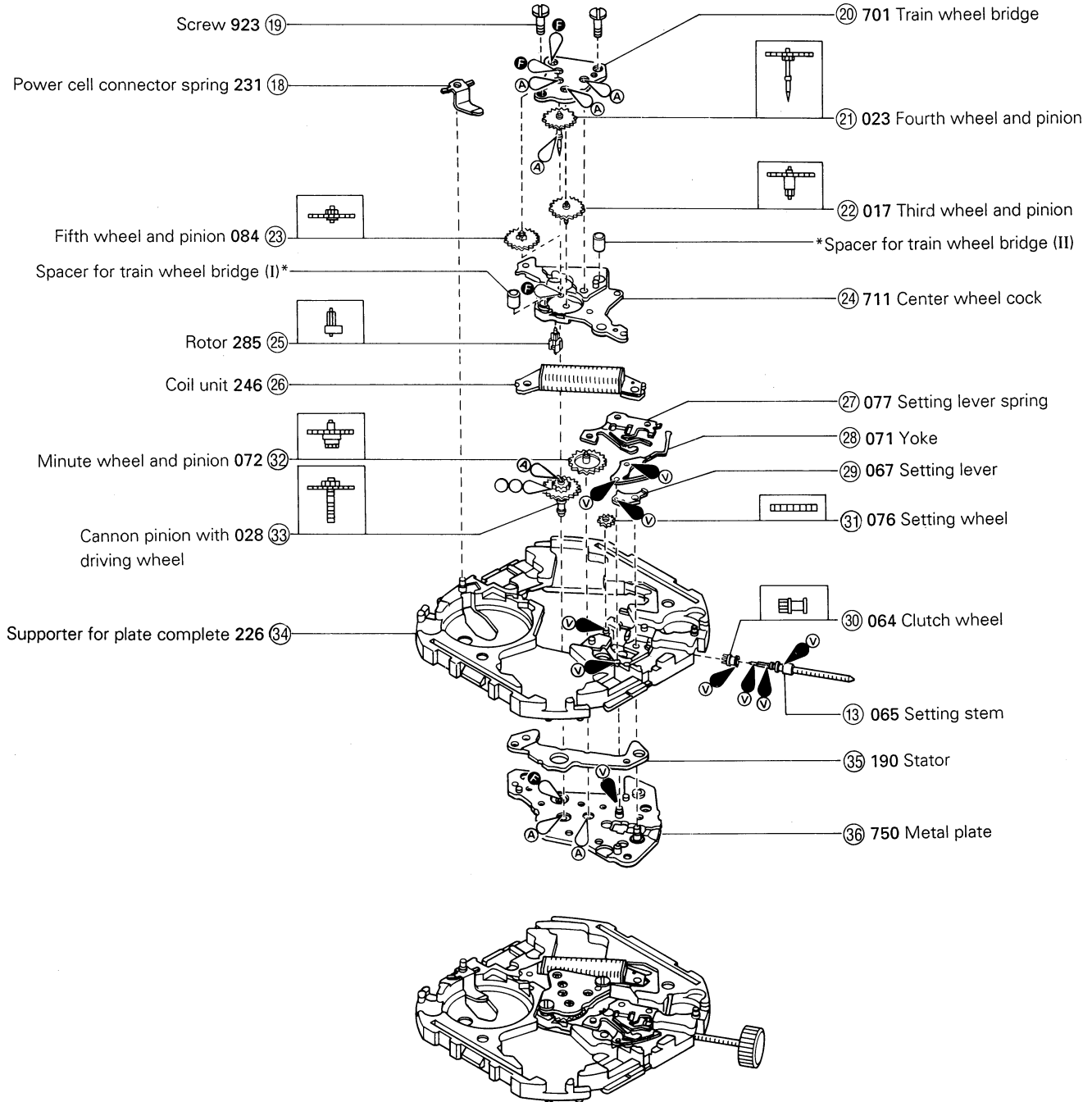
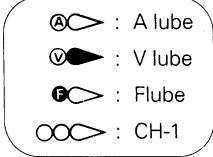

* Spacers (I) and (II) for train wheel Bridge are the set parts of the center wheel cock.

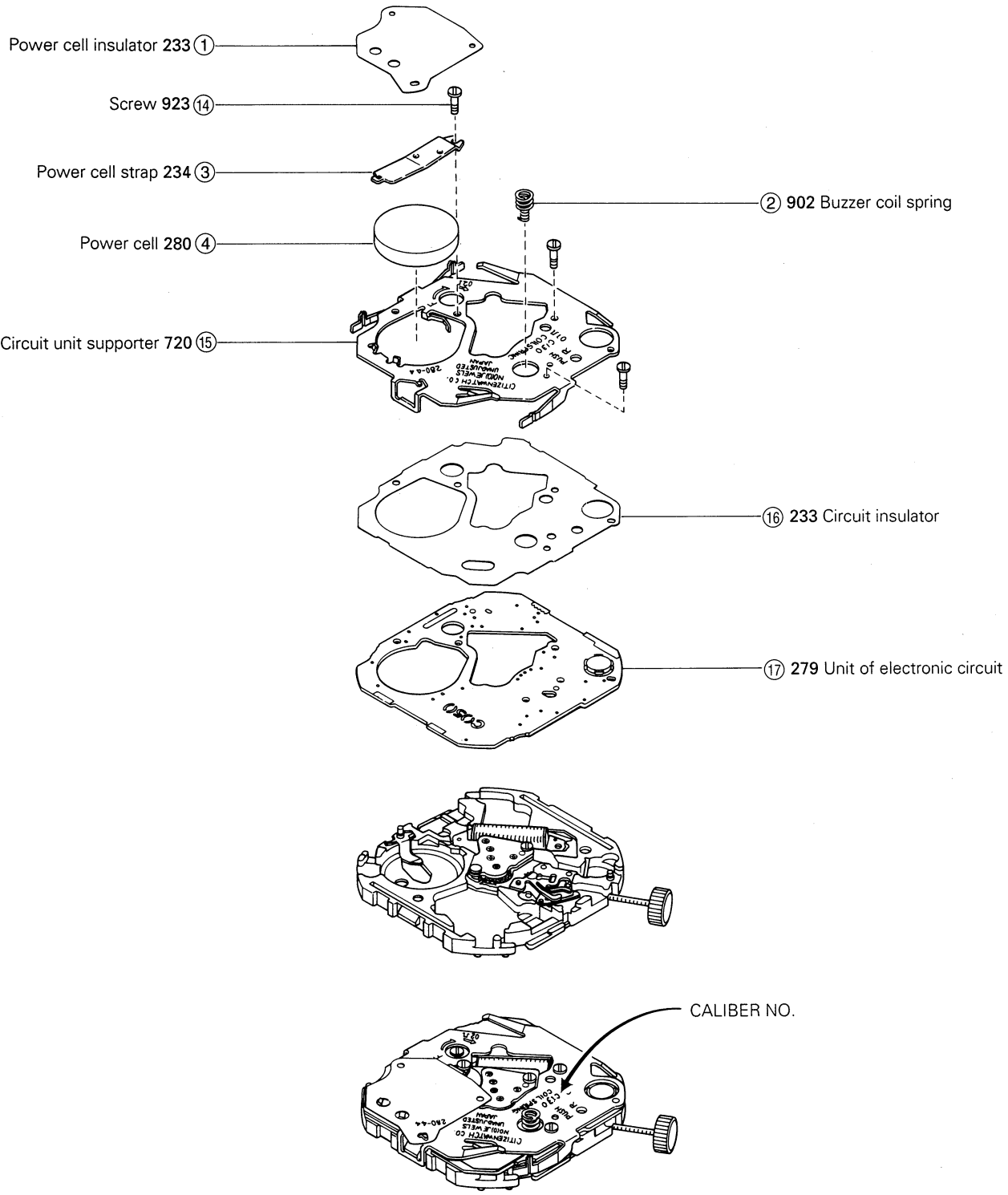



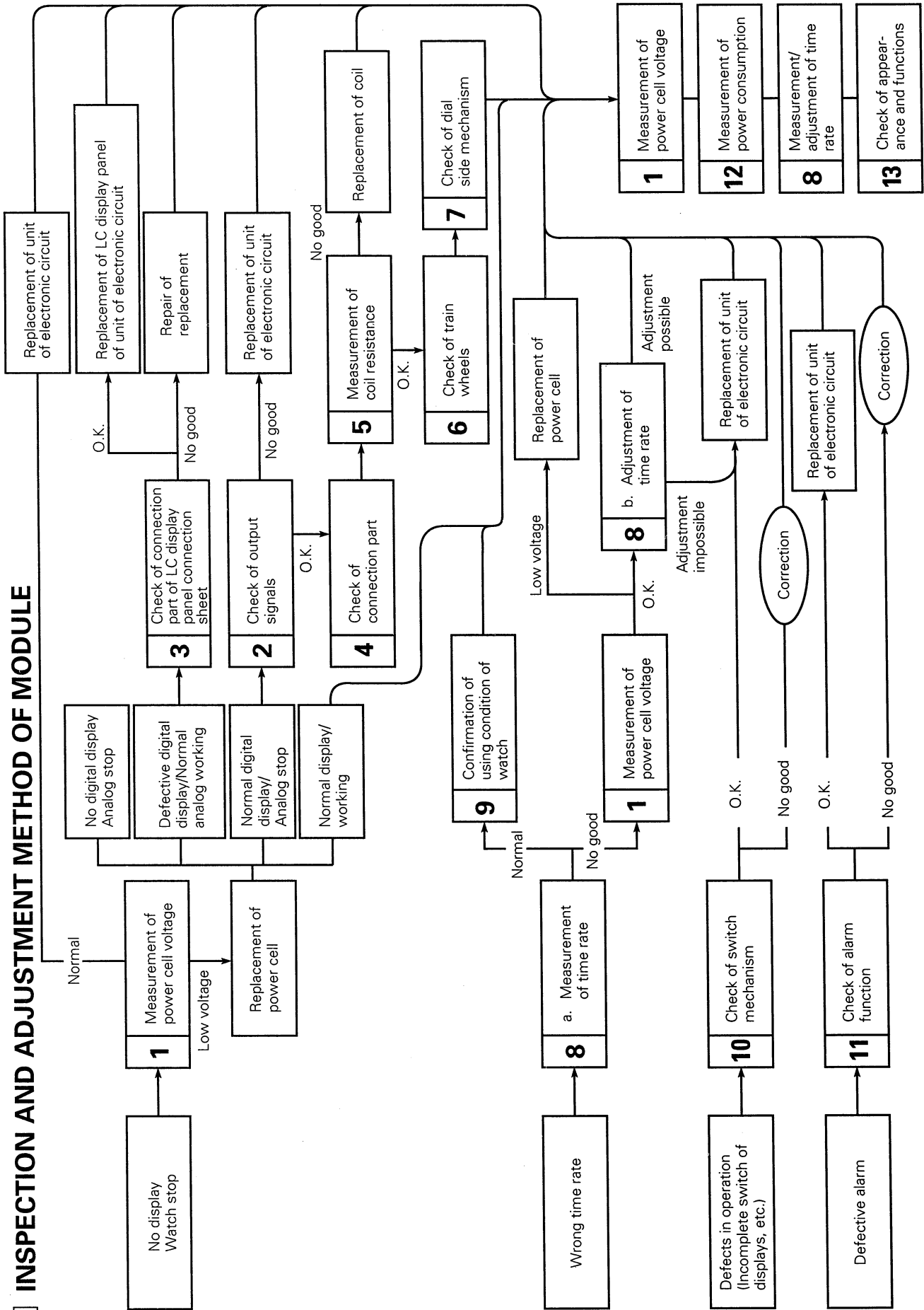

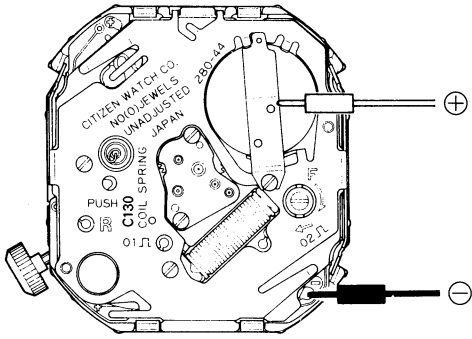
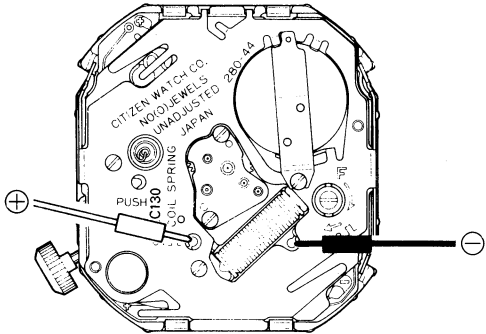
9 INSPECTION AND ADJUSTMENT METHOD OF MODULE

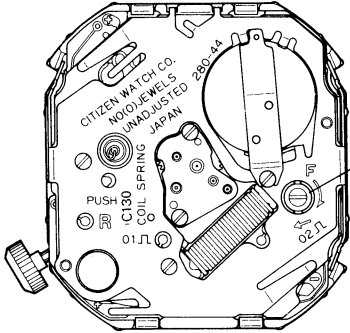

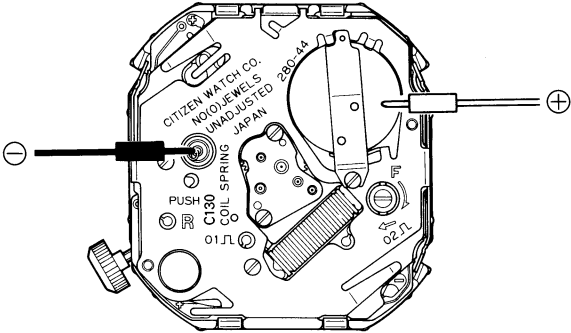
Check Points	How to check	Results & treatment
<p>① Measurement of power cell voltage</p>	<p>[Refer to Technical Manual, Basic Course II-1-a]</p> <p><Tester range: DC 12V></p> 	<ul style="list-style-type: none"> • Over 1.5 V → Normal • Under 1.5 V → Replace the power cell.
<p>② Check of output signals</p>	<p>[Refer to Technical Manual, Basic Course II-1-b]</p> <p><Tester range: DC 0.3 V></p>  <p>(The tester lead pins have no polarity.)</p>	<ul style="list-style-type: none"> • The tester pointer swings every 1 second. → Normal • The tester pointer does not swing. → Check the connections parts <p style="text-align: center;">↓</p> <ul style="list-style-type: none"> • The connections are normal. → Replace the electronic circuit unit.
<p>③ Check of LC display panel and connection part</p>	<p>[Refer to the Digital Section of Technical Manual, Basic Course II-2-a]</p> <ul style="list-style-type: none"> • Inspection of all segments Pull out the crown and push the (A), (B) and (C) button at the same time to turn on all the segments, and check for defective ones. (Refer to [6] ALL RESET OPERATION) • Continuity test on LC display panel, cell connection rubber and plate complete Check the parts for stain, breakage, etc. 	<ul style="list-style-type: none"> • LC display panel, connection rubber or metal plate is not installed correctly. → Install correctly • Parts are stained or dirty. → Remove stain and dirt. • Parts are cut, broken or scratched. → Replace parts.
<p>④ Check of connection part</p>	<p>[Refer to Analog Section of Technical Manual, Basic Course II-2-a]</p>	

Check Points	How to check	Results & treatment
<p>5 Measurement of coil resistance</p>	<p>[Refer to Technical Manual, Basic Course II-1-c]</p> <ul style="list-style-type: none"> Remove the unit of electronic circuit, then measure the resistance of coil. The tester lead pins have no polarity. <p style="text-align: right;"><Tester range: Rx10Ω></p>	<ul style="list-style-type: none"> 2.2 kΩ ~ 2.6 kΩ → Normal Outside range of 2.2 kΩ ~ 2.6 kΩ → Replace coil unit.
<p>6 Check of train wheels</p>	<p>[Refer to Technical Manual, Basic Course II-2-b]</p> <ul style="list-style-type: none"> Check clearance of each wheel. Check rotor for dust and oil. 	
<p>7 Check of dial-side mechanism</p>	<p>[Refer to Technical Manual, Basic Course II-2-c]</p> <ul style="list-style-type: none"> Confirm all parts are not deformed and are lubricated properly. 	
<p>8 Measurement and adjustment of time rate</p>	<p>[Refer to Technical Manual, Basic Course II-2-d]</p> <p style="text-align: center;">< Measurement range: > Analog, 2 sec.</p> <div style="text-align: center;">  </div> <ul style="list-style-type: none"> Turn trimmer capacitor to right and left to adjust time rate. 	<ul style="list-style-type: none"> Can be adjusted. → Normal Cannot be adjusted or large error is made after adjustment. → Replace the electronic circuit unit.
<p>9 Confirmation of using condition</p>	<p>[Refer to Technical Manual, Basic Course II-2-e]</p>	

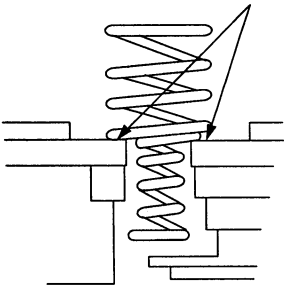
Check Points	How to check	Results & treatment
<p>⑩ Check of switch mechanism</p>	<p>1. Inspection of movement.</p> <ul style="list-style-type: none"> • Press the switch spring of circuit unit supporter with tweezers, etc. to contact it to plate complete, and confirm the switching function. • Check for removal of pattern of electronic circuit unit, deformation of switch return spring, etc. <p>2. Inspection of push button</p> <ul style="list-style-type: none"> • Check push button for deformation, stain, etc. <div style="border: 1px solid black; padding: 5px; margin-top: 10px;"> <p>(Note) Be sure to apply silicone oil to the packing of push button for waterproofness and smooth operation. Apply it to the packing of the sensor, too.</p> </div>	<ul style="list-style-type: none"> • Switching function is normal. → Inspect push button. • Pattern is removed or deformed. → Replace defective parts. • Push button is stained or deformed. → Remove stain, or replace push button.
<p>⑪ Check of alarm mechanism</p>	<p>[Refer to Technical Manual Basic Course II-1-d]</p> <p>*1. Set the module in the case, and check output of alarm signal with the case back removed.</p> <p>(1) Set the watch in alarm mode. (2) Apply ⊕ lead pin to power cell surface and ⊖ lead pin to buzzer contact spring, then press ⊙ button.</p> <p style="text-align: right;"><Tester range: DC 0.3V></p> <div style="text-align: center;">  </div> <p>*2. If the output of alarm is normal, perform the following inspection.</p> <ul style="list-style-type: none"> • Check the piezo-electric element of vibrating plate for cracks and breakage. • Check the buzzer contact spring for bend and deformation. • Check the pattern of electronic circuit unit for dust and stain. 	<ul style="list-style-type: none"> • Tester pointer does not swing. → Replace the electronic circuit unit. <div style="text-align: center;">  </div> <ul style="list-style-type: none"> • Tester pointer swings. → Normal <div style="text-align: center;">  </div> <ul style="list-style-type: none"> • Perform inspection in *2. <div style="text-align: center;">  </div> <p>Normal indication. → O.K</p> <ul style="list-style-type: none"> • Install the buzzer contact spring securely. When closing the case back, take care that the buzzer contact spring will not be removed or deformed. <div style="text-align: right;"> <p>Must be in contact with circuit board.</p>  </div>

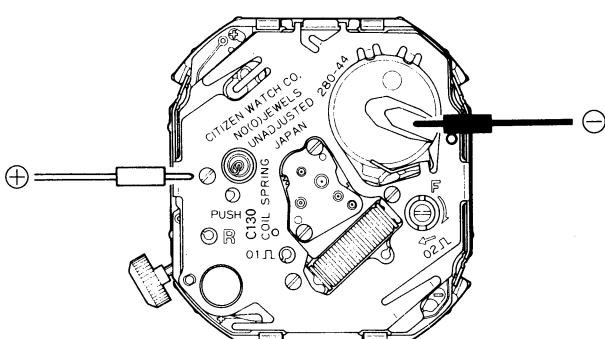
Check Points	How to check	Results & treatment
<p>⑫ Measurement of Current value (Power consumption)</p>	<p>[Refer to Technical Manual, Basic Course II-1-f]</p> <p>(1) Set the power cell to tester.</p> <p>(2) Set the lead bars of the tester to the module. Pull the crown and push the (A), (B), and (C) button at the same time, then push the crown (The all-reset operation procedure). Then, measure the current consumption.</p> <p style="text-align: center;"><Use the tester range: DC 12μA></p> 	<ul style="list-style-type: none"> • Measured value of module complete is under 3.1 μA. → Normal • Measured value of module complete is over 3.1 μA. → Inspect train wheel and dial side mechanism, and remove dust and stain, and oil. • Pull the crown to measure the power consumption under the reset state. → Normal <p>Under 2.5 μA. → Electronic circuit unit is defective.</p> <p style="text-align: center;">↓</p> <p>Replace the electronic circuit unit.</p>
<p>⑬ Check of appearance and functions</p>	<p>[Refer to Technical Manual, Basic Course II-2-f]</p> <ul style="list-style-type: none"> • Check inside of case for dust and stain. • Check operation of setting switches for normality. • Check segment for normality (See ④ Check LC display panel and connection part.) 	

CITIZEN WATCH CO., LTD.
Tokyo, Japan