

TECHNICAL INFORMATION

CITIZEN QUARTZ

Cal. No. C050

Cal. No. C070

Cal. No. C080

CONTENTS

1	OUTLINE	1
2	SPECIFICATIONS	2
3	OPERATING METHOD	
	3 -1 CAL C050 (Yacht)	5
	3 -2 CAL C070 (Racing)	15
	3 -3 CAL C080 (Pilot)	28
4	PRECAUTIONS FOR DISASSEMBLE AND ASSEMBLE OF MODULE	39
5	DISASSEMBLE AND ASSEMBLE OF MODULE	40
6	INSPECTION AND ADJUSTMENT METHOD OF MODULE	43

1 OUTLINE

● CAL C050

This is a combination watch having full functions for yacht sports.



- Time/Calendar function
- Alarm I/II function (Snooze time can be set in Alarm II mode.)
- Stopwatch function
- Racing timer function
- Timer function

● CAL C070

This watch is a regular racing watch having information necessary to races.



- Time/Calendar function
- Alarm function
- Stopwatch function
- Racing mode (Setting of number of laps and distance of circuit)
- Chronograph run mode (Latest lap time, Lap time difference, average lap time, highest lap time, rest of number of laps, difference between two racers)
- Stop mode (Final lap, final lap time difference, final average lap time, final highest lap time)

● CAL C080

This is a combination watch having the functions of a pilot watch and a world time watch. This watch can indicate the time, year, month, date, and day of each of 31 cities in the world.

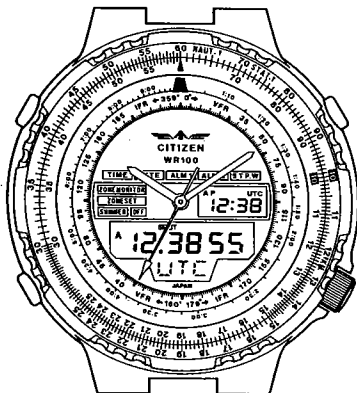

- Time/Calendar function
- Alarm I/II function
- Stopwatch function
- Zone monitor (31 cities, 22 zones)
- Zone setting function (Setting of summer time and cities)

2 SPECIFICATIONS

Caliber No.	C050	
Type	Combination watch	
Module size (mm)	26.0 x 27.4 Thickness: 4.9	
Accuracy (at normal temperature)	±20 sec./month	
Oscillation	32,768 Hz	
Indication	Digital section: FE type nematic LC (Liquid Crystal), Analog section: Three hands	
Integrated circuit	C/MOS-LSI (2 units)	
Effective temperature range	0°C ~ +55°C (32°F ~ 131°F)	
Converter	Step motor	
Adjustment of time rate	Trimmer condenser	
Measurement gate	2 seconds (Analog section)	
Display functions	Analog section	Hour/Minute/Second
	Digital section	Either time or calendar is indicated. Time: (AM/PM) Hour, minute, second (Second is indicated graphically. Set to 12/24-hour system.) Calendar: Month, date, day (Years from 1989 to 2004 are indicated only when changed.)
	(Time/Calendar)	
	(Alarm I)	(AM/PM) hour, minute (Time length up to alarm time is indicated graphically.)
	(Alarm II)	(AM/PM) hour, minute, snooze time (can be set to 0 ~ 10 minutes)
	(Stopwatch)	24-hour system, minute, second, 1/100 second (60 minutes max.) Hour, minute, second (longer than 60 minutes), second is indicated graphically.
	(Racing timer)	60-minute watch: Either automatic repeating function and automatic chronograph function can be used. (Rest of set time and automatic chronograph are indicated graphically.) With forecast sound.
	(Timer)	Minute, second, from 60 minutes to 1 minute by one minute (rest of set time indicated graphically)
Battery	Part No.	280-44
	Battery No.	SR927W
	Nominal voltage	1.55 V
	Nominal capacity	55 mA·H
	Lifetime	Approx. 2 years (in case alarm is used for 20 seconds every day)
	Current consumption	3.1 μA max.
	Coil resistance	2.2 kΩ ~ 2.6 kΩ

* The above specifications are subject to change.

* After a new battery is installed, the watch keeps its accuracy for about two years in case the watch is used under normal condition. However, the lifetime of the battery depends on the frequency of use of the alarm.

Caliber No.	C070	
Type	Combination watch	
Module size (mm)	26.0 x 27.4 Thickness: 4.9	
Accuracy (at normal temperature)	±20 sec./month	
Oscillation	32,768 Hz	
Display method	Digital section: FE nematic LC (Liquid Crystal) Analog section: Three hands	
Integrated circuit	C/MOS-LSI (2 units)	
Effective temperature range	0°C ~ +55°C (32°F ~ 131°F)	
Converter	Step motor	
Adjustment of time rate	Trimmer condenser	
Measurement of time rate	2 seconds (Analog section)	
Additional functions of digital section	(Watch mode) Time/Calendar	(Time and Calendar are indicated simultaneously.) Time: Hour, minute and second (AM/PM) Calendar: Month, date, day, year (1989 ~ 2004), Fully automatic calendar (Current time and Alarm set time are indicated simultaneously.)
	Alarm	Hour, minute (AM/PM)
	Stopwatch	(Lap time and Split time are indicated simultaneously.) Lap time: Minute, second, 1/100 second (Repeated every 60 minutes) Split time: Hour, minute, second, 1/100 second (Repeated every 100 hours) (Indication of number of laps. (Repeated 199 times.) Measurement unit: 1/100 second, best five laps memory
	(Racing mode) Setting of number of laps Setting of distance of circuit	0 ~ 199 laps 0 ~ 99.999 (km) (by unit of 0.001 km)
	(Chronograph run mode) Latest lap time Lap time difference Average lap time Highest lap time Rest of number of laps Difference between two racers	Latest lap time, number of laps up to now, latest split time Lap time difference, number of laps up to now, speed (Speed higher than 1000 km/h is indicated by bar) Average lap time (Lap time longer than 60 minutes is indicated by bar), number of laps up to now, average speed Highest lap time, number of lap at which highest lap was recorded, highest average speed Rest of number of laps, rest of distance Split time difference, number of laps
Battery	(Lap mode) Final lap Final lap time difference Final average lap time Final highest lap time	Final lap time, final number of laps, final split time Lap time difference, final number of laps, average speed Average lap time, final number of laps, average speed Highest lap time, number of lap at which highest lap time was recorded, highest speed.
	Part No.	280-44
	Battery code	SR927W
	Nominal voltage	1.55 V
	Nominal capacity	55 mA·H
	Lifetime	Approx. 2 years
	Current consumption	3.1 μA max.
Coil resistance	2.2 kΩ ~ 2.6 kΩ	

* The above specifications are subject to change.

* After a new battery is installed, the watch keeps its accuracy for about two years in case the watch is used under normal condition. However, the lifetime of the battery depends on the frequency of use of the alarm.

Caliber No.	C080	
Type	Combination watch	
Module size (mm)	26.0 x 27.4 Thickness: 4.9	
Accuracy (at normal temperature)	±20 sec./month	
Oscillation	32,768 Hz	
Display method	Digital section: FE nematic LC (Liquid Crystal) Analog section: Three hands	
Integrated circuit	C/MOS-LSI (2 units)	
Effective temperature range	0°C ~ +55°C (32°F ~ 131°F)	
Converter	Step motor	
Adjustment of time rate	Trimmer condenser	
Measurement of time rate	2 seconds (Analog section)	
Display functions	(Digital section) Time	Main time: (AM/PM) Hour, minute, second, city (Three alphabets) Sub time: (AM/PM) Hour, minute Can be set to 12 or 24-hour system.
	Calendar	Calendar: Month, date, day, city (Three alphabets), fully automatic calendar Sub time: (AM/PM) Hour, minute
	Alarm I	Set time of alarm I: (AM/PM) Hour, minute, city (Three alphabets) Sub time: (AM/PM) Hour, minute
	Alarm II	Set time of alarm II: (AM/PM) Hour, minute, city (Three alphabets) Sub time: (AM/PM) Hour, minute
	Stopwatch	Hour, minute, second, 1/100 second (24-hour system)
	Zone monitor	Confirmation of cities and SET/OFF (31 cities, 22 zones)
	Zone setting	SET/OFF of cities and summer time
Battery	Parts No.	280-44
	Battery	SR927W
	Nominal voltage	1.55 V
	Nominal capacity	55 mAH
	Lifetime	Approx. 2 years
	Current consumption	3.1 μA max.
	Coil resistance	2.2 kΩ ~ 2.6 kΩ

* The above specifications are subject to change.

* After a new battery is installed, the watch keeps its accuracy for about two years in case the watch is used under normal condition. However, the lifetime of the battery depends on the frequency of use of the alarm.

3-1 OPERATING METHOD CAL C050 (Yacht)

§1 Name of Each Part

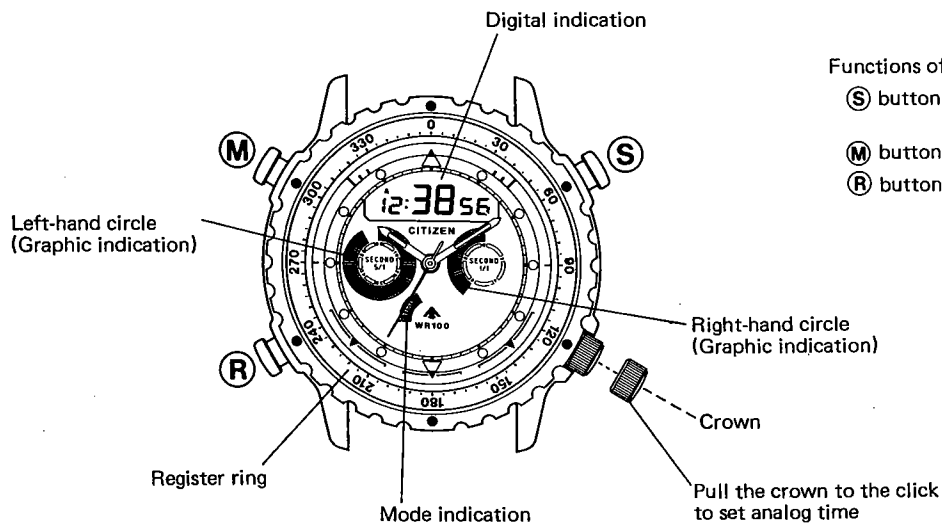

Functions of each button

- Ⓢ button: Selection of column to be corrected, start/stop
- Ⓜ button: Mode changeover
- Ⓡ button: Correction, split/reset

§2 Handling of Digital Section

INDICATION CHANGEOVER

The mode is changed in the following order every time the Ⓜ button is pressed.

* For details, see the section of each function.

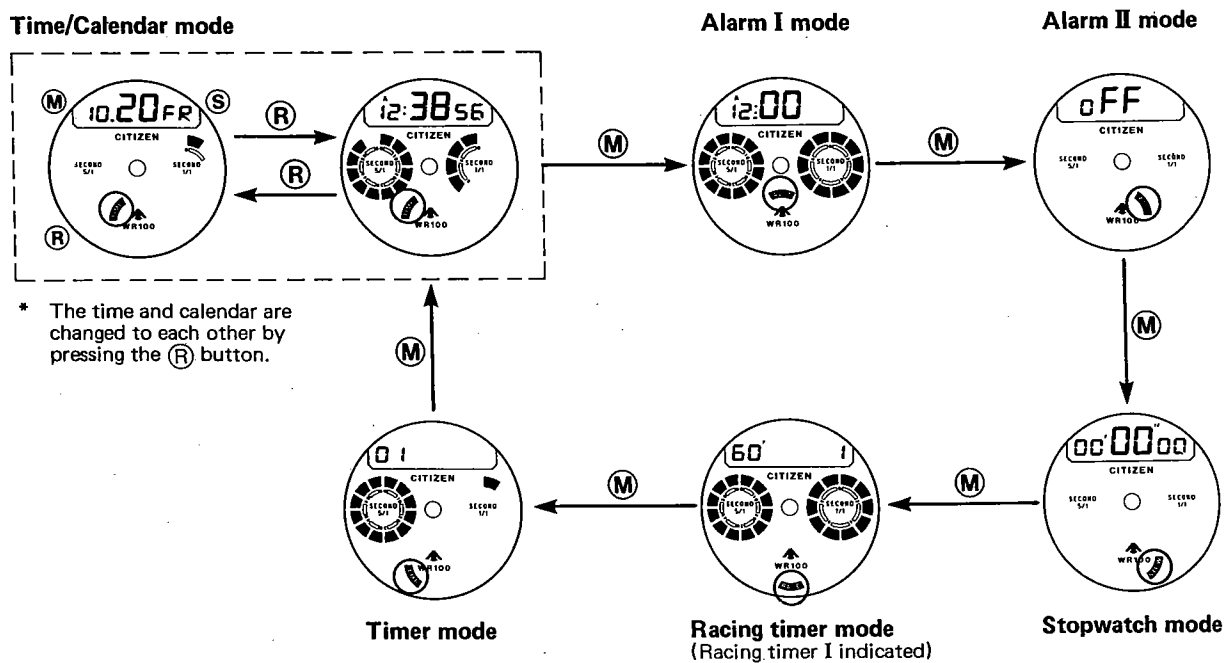

* The time and calendar are changed to each other by pressing the Ⓡ button.

Note: ○ marks indicate flashing parts.

(Returning to time/calendar mode)

If the (M) button is pressed and held for about two seconds, the watch is forcibly returned to time/calendar mode. However, the watch is kept under the normal condition of each mode during correction.

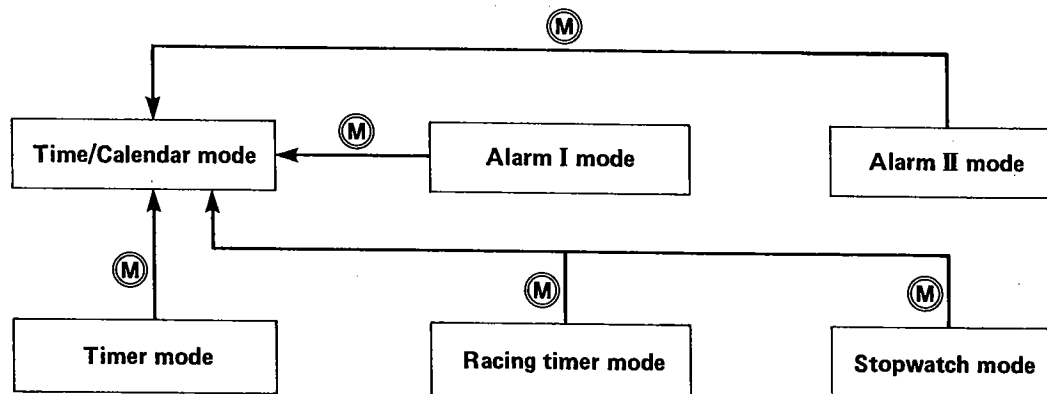

(Lighting up of mode mark)

Under the normal condition of the time/calendar mode, each mode mark lights up when **the alarms I and II are turned on and the stopwatch, racing timer and timer are running.**

Example

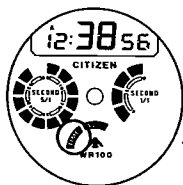

Time/Calendar mode
(With alarm I turned on)

a. HANDLING METHOD IN TIME/CALENDER MODE

Press the (S) button to call the part to be corrected, and correct it with the (R) button.
 The part to be corrected can be corrected quickly by pressing and holding the (R) button while the part is flashing (except the second indication and change of 12/24 hour system.)

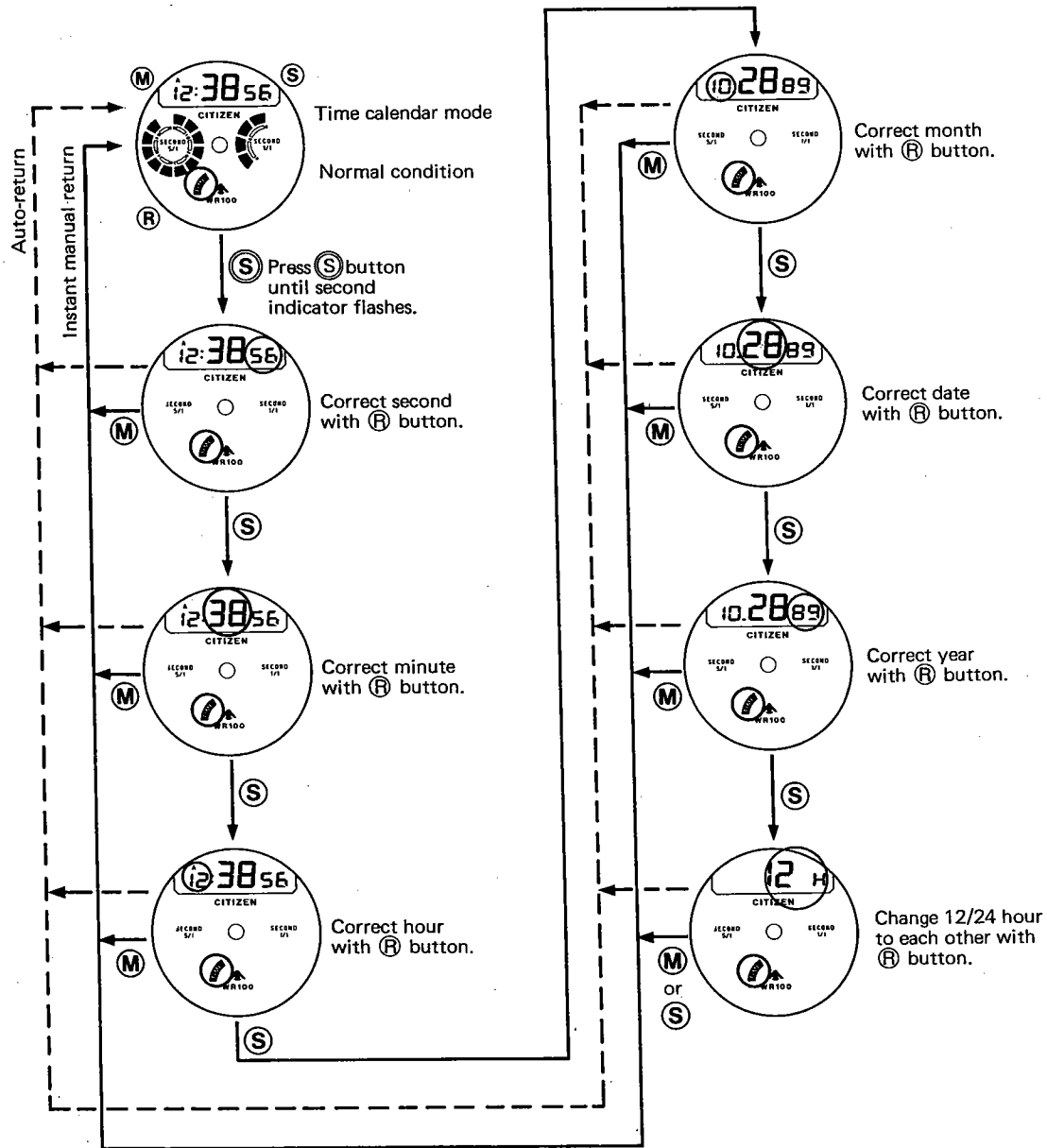

(Auto return)

If the watch is left untouched for about two minutes in the correction mode, the watch is automatically brought to the normal mode.

(Instant manual return)

If the (M) button is pressed in any correction mode, the watch is forcedly returned to the time/calendar mode.

(Other precautions)

- If the second is corrected when the second indicator is between 30 and 59 seconds, the minute is raised by one minute.
- If a date which does not exist is set, the watch automatically indicated the 1st of the next month when returned to the normal mode.
Example: Feb. 31th → Mar. 1st
- Year can be set to 1989 – 2004, and it is not necessary to adjust the date at the end of any month during these years.
- Day is automatically set when year, month and date are set.

(Graphic indication of second)

- The right-hand and left-hand circles graphically indicate seconds according to the normal time.

b. SETTING METHOD OF ALARM I

Setting of alarm time

- The alarm is turned on and off and the confirmation sound comes out every time the (R) button is pressed in alarm mode I.
Call the part to be corrected by pressing the (S) button, and set the alarm with the (R) button.
The alarm can be set quickly by pressing and holding the (R) button in the correction mode (while correction part is flashing).

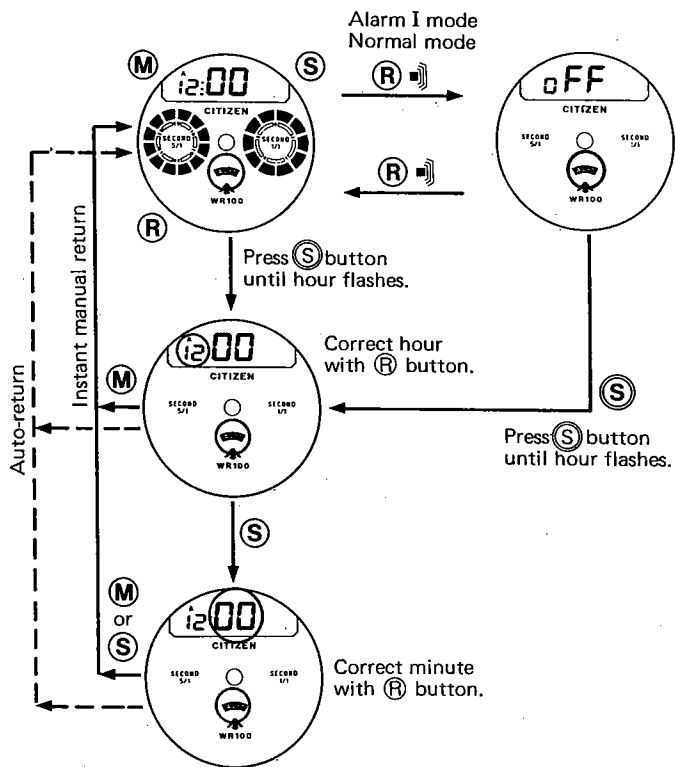

Note: ■ Confirmation sound mark.

- The 12/24 hour systems are in accordance with the time/calendar mode.
- If the watch is left untouched for about two minutes in the correction mode, the watch automatically returns to the normal condition (Auto return).
- If the (M) button is pressed in the correction mode, the watch can be forcedly returned to the normal condition (Instant manual return).
- The alarm sounds for about 20 seconds. It can be stopped by pressing any button.

(Graphic indication of rest of alarm time)

The difference between the normal time and set time of alarm I (the rest of set time) is indicated graphically.

Left-hand circle:

While rest of alarm time is longer than 60 minutes, all are lighted up. When it becomes shorter than 60 minutes, it is indicated graphically.

Right-hand circle:

While rest of alarm time is longer than 10 minutes, all are lighted up. When it becomes shorter than 10 minutes, it is indicated graphically.

c. SETTING METHOD OF ALARM II

Setting of alarm time and snooze time

- Alarm II is set similarly to alarm I. However, snooze time can be additionally set in case of alarm II.
(Note: Snoozing is repeated only one time.)
- Snooze time can be set from 0 to 10 minute by the unit of 1 minute.

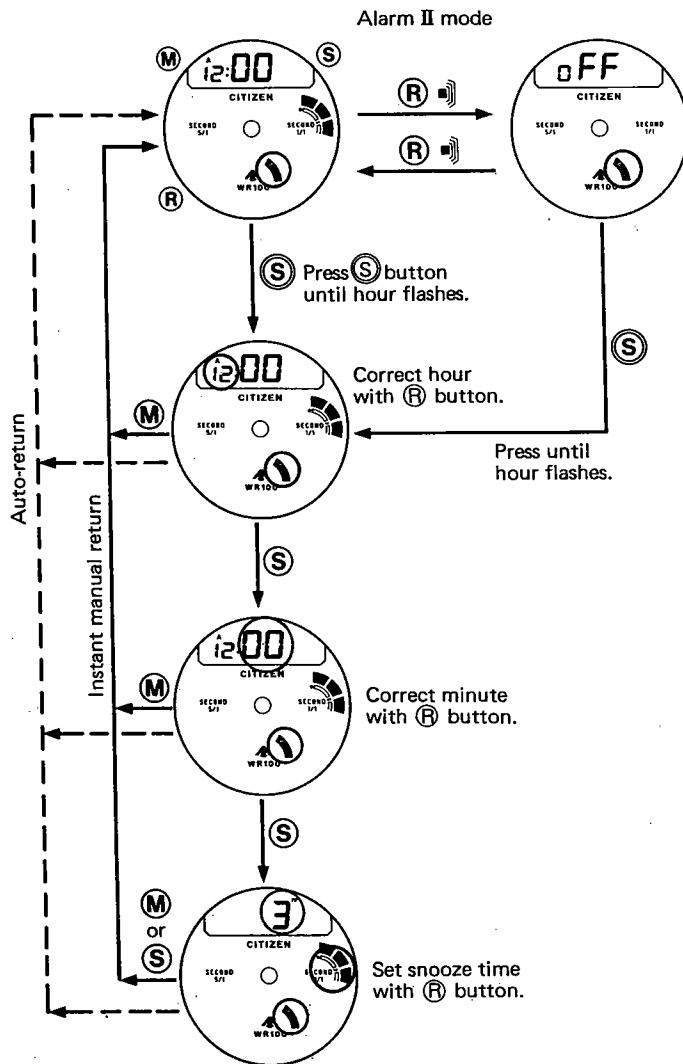

(Snooze)

- The mechanism sounds alarm again at the setting time after the alarm II sounds. This is effective to prevent the user from sleeping after the alarm is stopped.

Note: If the snooze time is set to 0 minute, the snooze sound does not come out.

Example:

If the snooze time is set to three minutes, the snooze sound comes out three minutes after alarm II sounds.

(Graphic indication of snooze time)

The snooze time set by alarm II is indicated graphically by the righthand circle only.

d. HANDLING METHOD OF RACING TIMER

- This watch contains two types of racing timers; racing timer I and racing timer II. These timers can be changed from one to another by pressing the **(R)** button and **(S)** button at the same time in the initial setting mode. At this time, the confirmation sound comes out.

Racing timer I

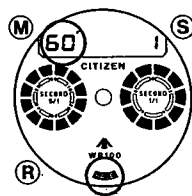

Racing timer II

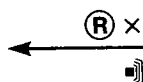
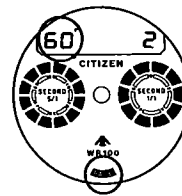

(Items common to racing timers I and II)

- Set the timer by pressing the (R) button in the initial setting mode. If the (R) button is kept pressed, the timer can be set quickly.
- The timer can be set to 3 minutes through 60 minutes by steps of 5 minutes (60, 55, ——— 10, 5, 3 minutes).
- Stopping the sound
The alarm sounds for about five seconds each time the timer is up. This sound can be stopped by pressing any button.
- Forecast sound
The forecast sound comes out when the rest of the set times 10, 5 and 3 minutes and 50, 40, 30, 20, 10, 5, 4, 3, 2, 1 seconds. (This function is used for preparation of start.)
- Fly-back (manual return and start)
If the (R) button is pressed while the timer is running, the timer is returned to the initial setting mode, then it starts again. (This function is used to adjust the timing of start.)

(Other remarks)

- Racing timer I is equipped with the automatic repeating function and II is equipped with the automatic chronograph function. It is required to set either one of timer I and II, and they cannot be set independently.

(Racing timer I)

Use: Convenient for repeated starts of yacht races

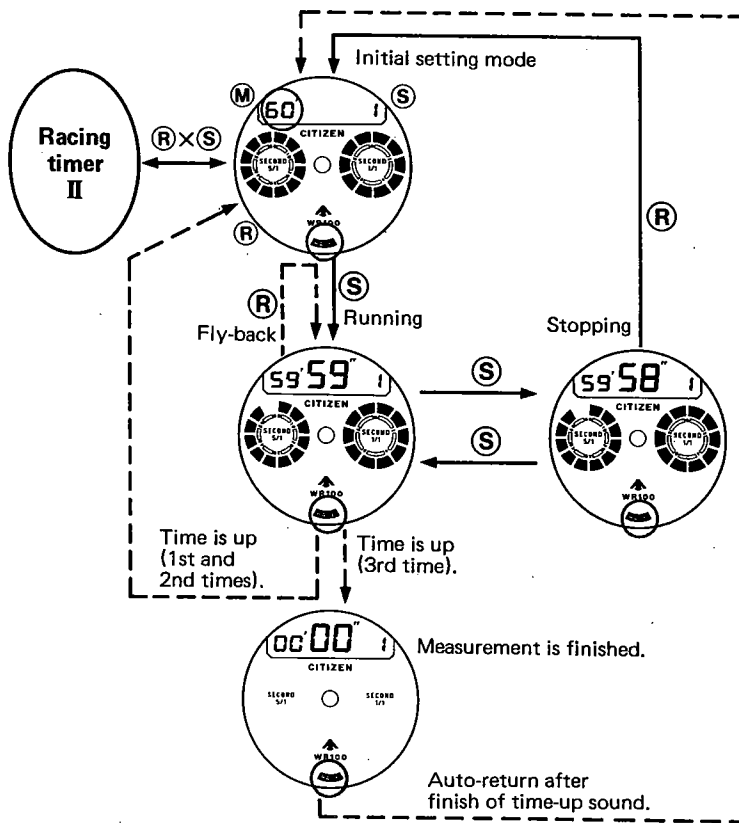

- Racing timer I is equipped with the automatic repeating function.

Automatic repeating function

(For timer operation)

The timer is automatically operated three times. After it is repeated three times, (00'00'') is indicated, then it returns to the initial setting mode and stops.

However, the fly-back operation is performed or the timer is changed, the number of automatic repeating time is renewed.

(Fly-back operation: The function of returning to the initial setting mode and starting again automatically when the (R) button is pressed while the timer is running.)

(Racing timer II)

Use: Convenient for measurement of time required for a yacht race

- Racing timer II is equipped with the automatic chronograph function.

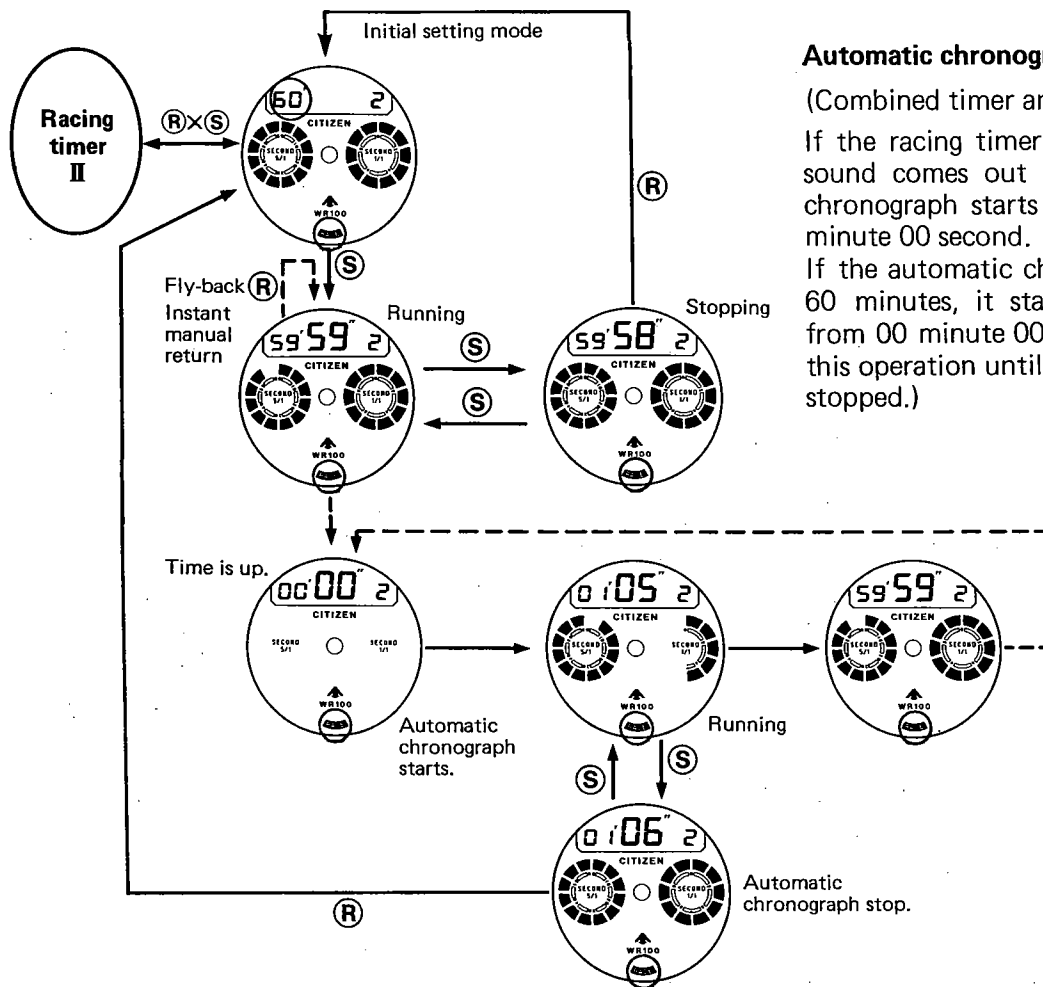

(Graphic indication of racing timer)

The set time and the rest of the time of the racing timer and the timer are indicated graphically.

Left-hand circle:	While rest of alarm time is longer than 60 minutes, all are lighted up. When it becomes shorter than 60 minutes, it is indicated graphically.
Right-hand circle:	While rest of alarm time is longer than 10 minutes, all are lighted up. When it becomes shorter than 10 minutes, it is indicated graphically.

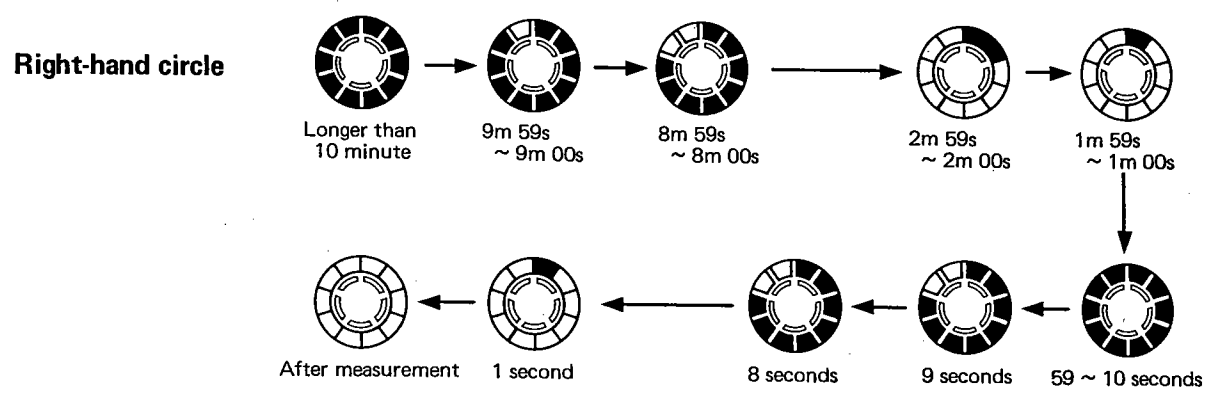
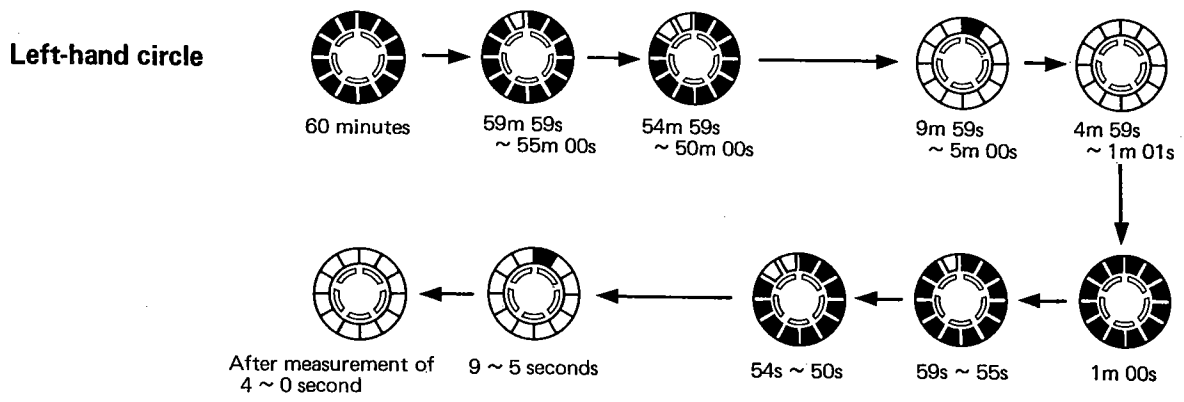

(Graphic indication of automatic chronograph)

The second figure of the automatic chronograph are indicated graphically.

e. HANDLING METHOD OF TIMER

The timer is operated similarly to the racing timer. The difference between the timer and racing timer is as follows.

- The timer is set to 1 to 60 minutes by the unit of 1 minute.
- The timer is not equipped with the forecast sound function, automatic repeat function and automatic chronograph function.

* For the graphic indication, see the section of the racing timer.

§3 Handling of Analog Section

SETTING OF ANALOG SECTION

The digital section and analog section can be set independently, that is, this watch can indicate dual times.

(How to set analog sections)

Pull the crown to the first click position so that the second hand will stop at 0 point, then set the hour hand and minute hand. Push in the crown according to a time signal, and the analog section is set correctly.

Advance the minute hand by four or five minutes over the time to which you want to set, then return it to that time.

After the analog section is set, be sure to push in the crown.

How to Use Rotary Ring

PREPARATORY KNOWLEDGE

In case of a common yacht race, the marks shown in right figure are set, and the racers sail around those marks in order as fast as they can.

The directions are indicated by angles, e.g. North: 0° , South: 180° , West: 270° , etc.

To sail the yacht receiving wind from the right of its center is called starboard reach, and to sail it receiving wind from its left is called port reach.

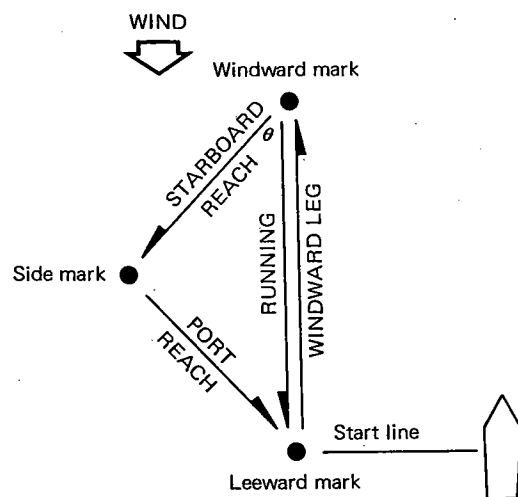

USING MEHOD 1

- (1) Before starting the race, read the position of the windward mark with a compass, then set it to the triangle mark at 12 o'clock point.
- (2) The course from the windward mark to the side mark (starboard reach) is in the direction indicated by the green triangle mark at left lower point. Accordingly, even if the side mark is not seen because of weather condition, you can reach the side mark by sailing in the indicated direction.
- (3) Similarly, the course from the side mark to the leeward mark (port reach) is indicated by the red triangle mark at the right lower point. Accordingly, you should sail in that direction.
- (4) Similarly, it is possible to know the course from the windward mark to leeward mark by reading the numeral indicated by the white triangle mark at the lower point.

* However, the above operation is effective only when is set to 45° . If it is set to 60° , for example, it is required to read the numerals above the green and red triangle marks to see the correct course. If it is set to 30° , it is required to read the numerals under the green and red triangle marks.

USING METHOD 2

Usually, a yacht can sail against wind at up to about 45° to it (even at 40° in case of a high performance yacht). If the yacht is sailed against the windward at the limit angle to it and that angle is set to the red (green) mark at the right upper (or left upper) point, the shifting of the wind can be seen. By this operation, you can sail your yacht in a more advantageous direction.

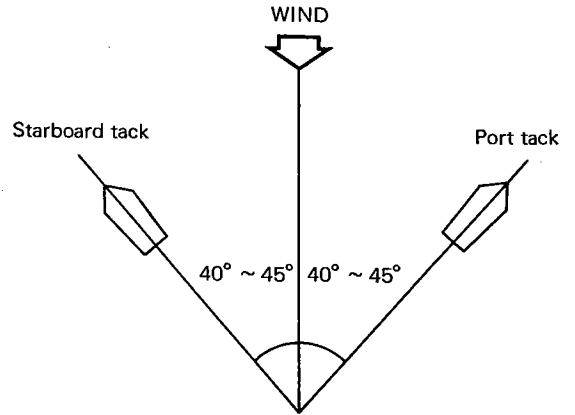

USING METHOD 3

The rotary ring can be used to see the inclination of the start line. Usually, the start line is set at a right angle to the wind direction. However, since the wind constantly changes, the start line is seldom set at a right angle to it.

First, set the wind direction to the white triangle mark at 12 o'clock position, and sail the yacht from one end to the other. At this time if the yacht sails on + side of the white line at 3 o'clock position (or 9 o'clock position), you should start from a point near the end at which you are aiming at now. If the yacht is on - side, you should start from a point near the opposite end.

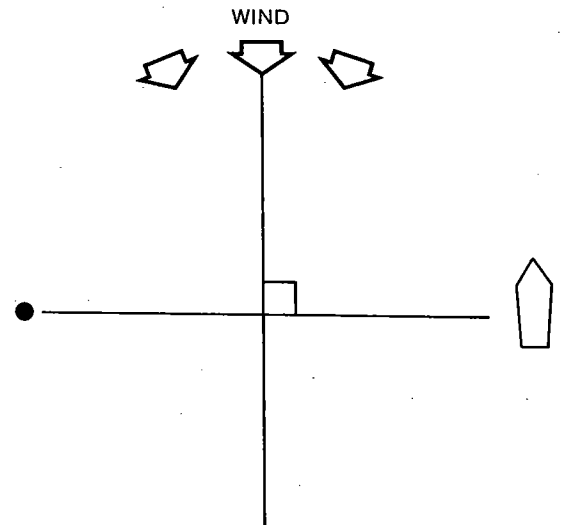

* By using the above three functions, you can bring your yacht to a more advantageous position.

3-2 OPERATING METHOD CAL C070 (Racing)

§1 Name of Each Part

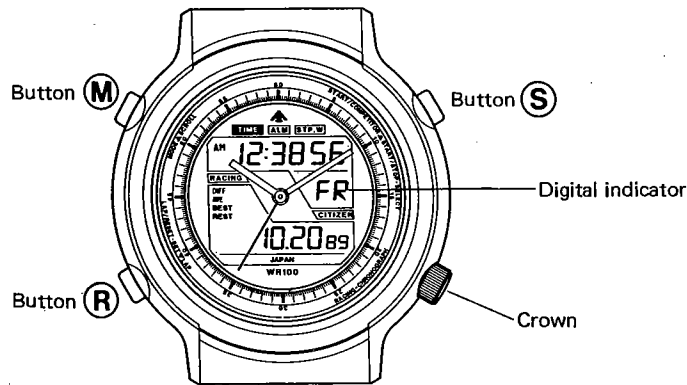

Analog Section

SETTING THE TIME

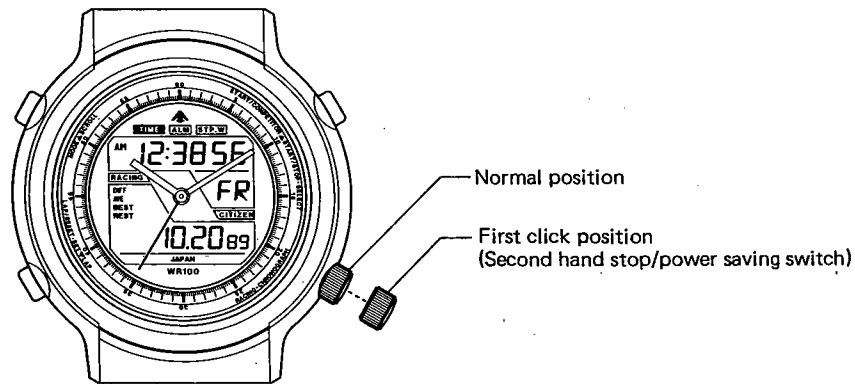

- Since the digital section and analog section can be independently set, this watch can be used as a dual-time watch.
- Set the time similarly to a common analog watch with the crown pulled to the first click position.
- After the time is set, securely return the crown to its normal position.

§2 Digital Section

(Large modes)

The digital section has two large modes; the time mode and racing mode. Each large mode has several small modes. For the detail, see the section of the change of indication.

(Changeover between large modes (Time mode and racing mode))

The time mode and the racing mode can be changed to each other by pressing and holding the (M) button (for about two seconds).

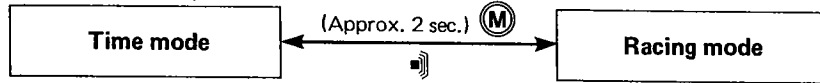

Confirmation beep

1. Small Modes of Time Mode

a. SETTING THE TIME AND CALENDAR

Call the item to be set by pressing the (S) button, and set it with the (R) button. If the (R) button is pressed and held in the setting (flashing) state, the indicated item is changed quickly (except setting of second and change of 12/24 hour systems).

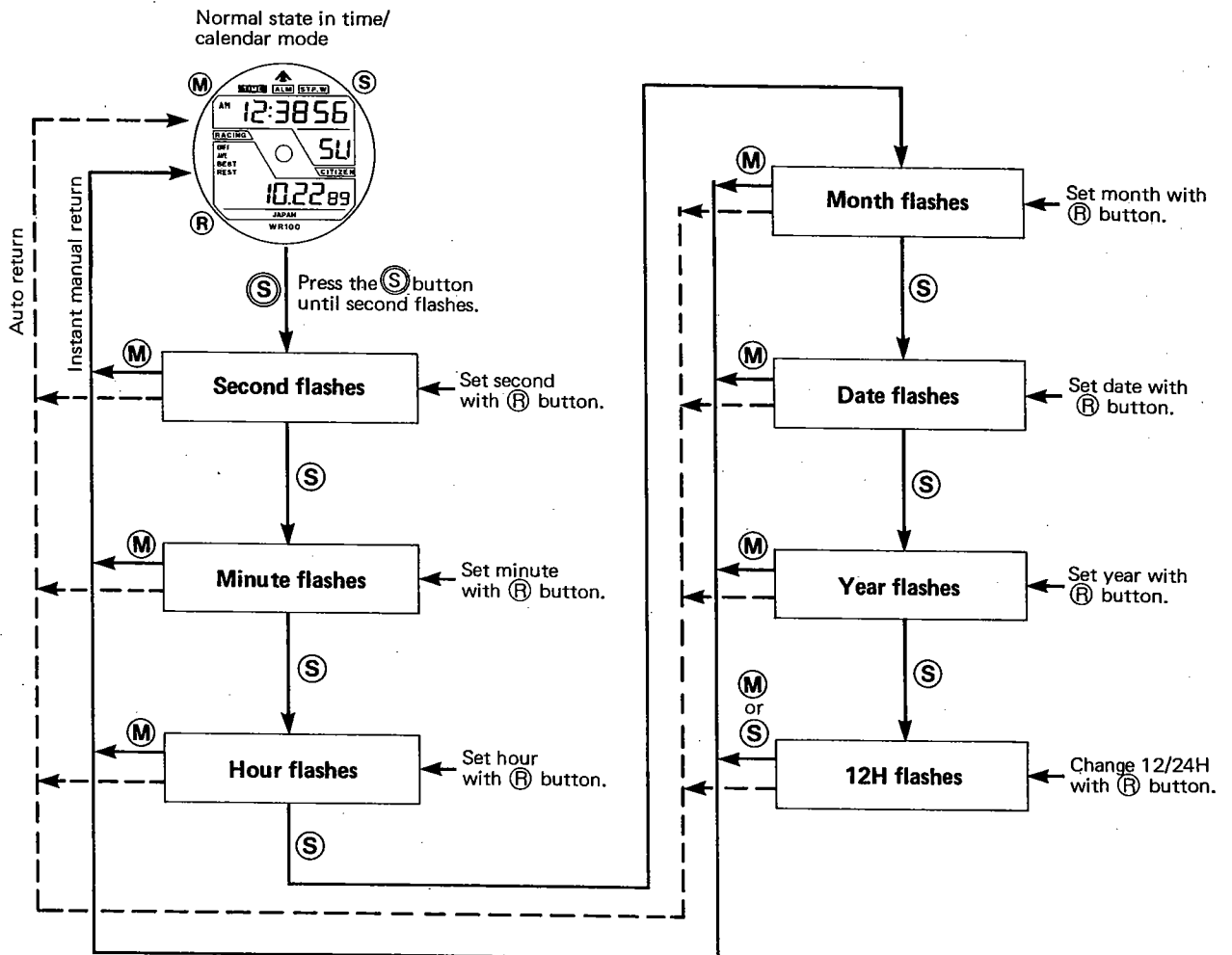

(Auto return)

If the watch is left in the setting state for about two minutes, the watch is automatically returned to the normal state.

(Instant manual return)

The watch can be returned to the normal state in the time/calendar mode from any setting state by pressing the (M) button.

(Other precautions)

- If the second is set during the period of 30 – 59 seconds, the minute goes forward by one minute.
- If an unexisting date is set, the watch automatically indicates the first of the next month when it is returned to the normal state.
Example: Feb. 31 → Mar. 01
- The year can be set to 1989 – 2004. If it is set to any year in this period, the calendar does not need to be corrected.
- The day of the week is automatically set when the year, month and date are set.

b. HOW TO USE ALARM

- The alarm is turned on and off and the confirmation sound comes out every time the (R) button is pressed in the alarm mode.
Call the item to be set by pressing the (S) button, and change it by pressing the (R) button. If the (R) button is pressed and held in the setting (flashing) state, the indicated item is changed quickly.
- The 12/24 hour systems is interlocked with the time/calendar mode.
- If the watch is left in the setting state for about two minutes, the watch is automatically returned to the normal state (Auto return).
- The watch can be returned to the normal state in the time/calendar mode from any setting state by pressing the (M) button (Instant manual return).
- The alarm sounds for about 20 seconds. It can be stopped by pressing any button.

Normal state in alarm mode

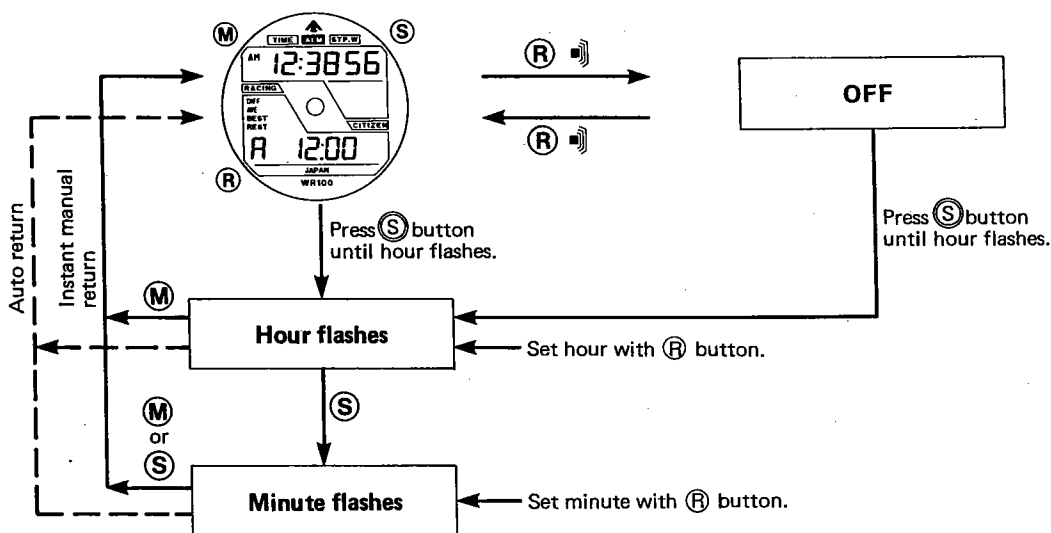

c. HOW TO USE STOPWATCH

The function of calling the five shortest lap times can be used in this mode.

Operate the (R) and (S) buttons in the stopwatch mode. (The confirmation sound comes out every time the (R) or (S) button is pressed.)

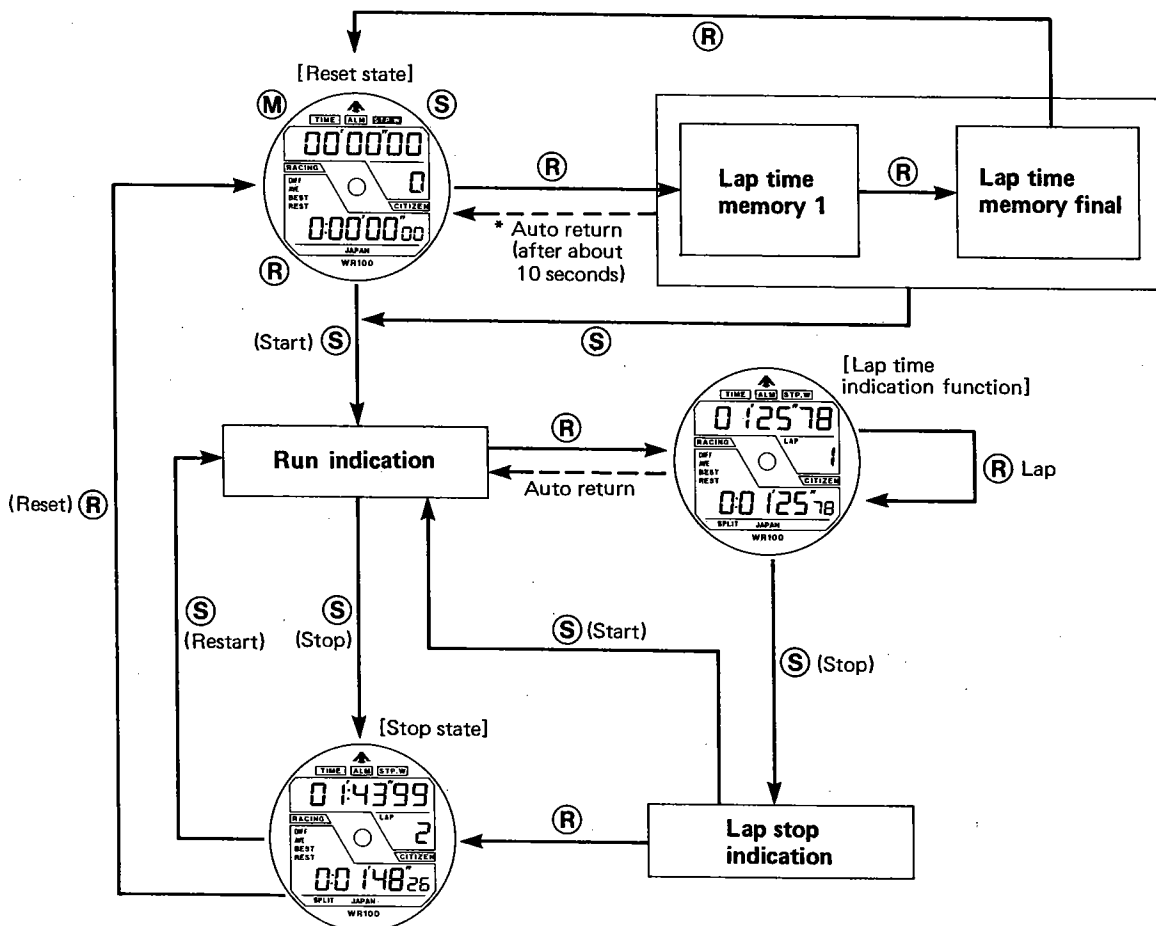

MEASURING RANGE

- Lap time: From 00 minute 00 second 00/100 second to 59 minutes 59 seconds 99/100 seconds. (Repeated)
- Split time: 0 hour 00 minute 00 seconds 00/100 second to 99 hours 59 minutes 59 seconds 99/100 second (Repeated)
- Number of laps: 0 to 199 (Repeated)

(Indication of number of laps)

The number of laps is counted every time the lap time is measured and the measurement is stopped.

(Storage of five shortest lap times)

If the watch is reset and started, the lap time and the number of laps are stored every time the lap time is measured and measurement is stopped. If the lap time is measured two or more times, up to five data are arranged and stored from the shortest one. If the sixth or a later lap time is shorter than any of the stored five data, it is stored, too.

(The five shortest lap times are constantly stored.)

Note: When the watch is set to the racing mode, the memory of the five shortest lap times is deleted.

(Indication of stored five shortest lap times)

If the watch is reset and the (R) button is pressed, the shortest lap time memory appears and which turn that lap time was recorded in are indicated. Every time the (R) button is pressed, the lap times are indicated from the next shortest one. This data is deleted when the stopwatch mode is started again.

(Auto return from indication mode of five shortest lap times)

If the watch is left unoperated for about 10 seconds in the indication mode of the five shortest lap times, it is reset.

(Lap time and split time)

Lap time: Time required to cover one interval

Split time: Time required to cover distance from start point

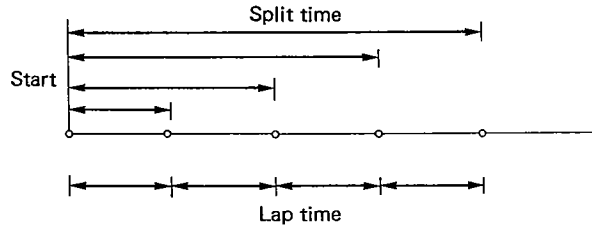

2. Small Modes of Racing Mode

- Change to racing mode

If the (M) button is pressed for about two seconds in the time mode (Time/Calendar mode, alarm mode and stopwatch mode), the watch is changed to the number-of-laps setting mode in the racing mode. (However, it cannot be changed from the setting mode).

- In this mode, if the number of laps to be covered and the distance of the circuit are set in advance, the information necessary to each race can be indicated.

Example: In case of a race to cover 10 laps of a 5-km circuit

a. ■ Setting of number of laps to be covered

Note: : Flashing mark
 ○ : Item to be changed
 ← : Auto return

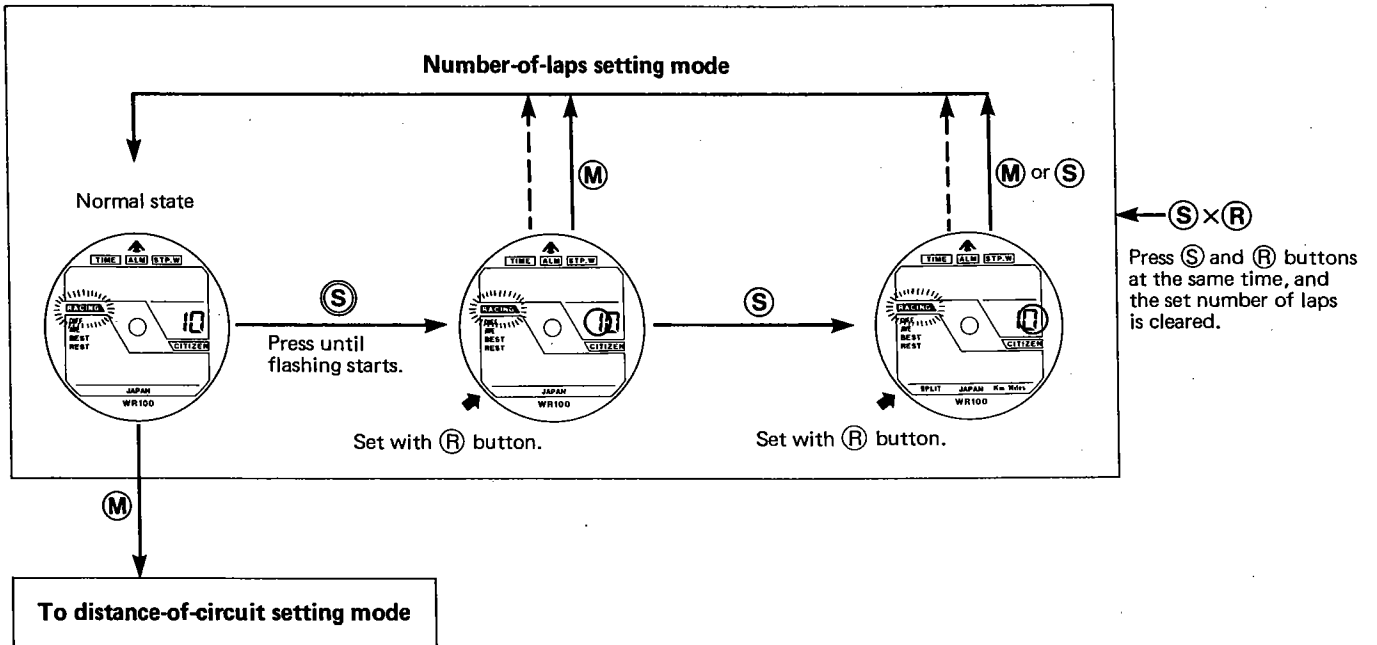

- Number-of-laps setting mode
How many times each racer must run the circuit can be set in this mode. The range of the setting of the number of laps is 0 – 199.
 - Call the item to be changed with the (S) button and set the number of laps to be covered with the (R) button. If the (R) button is pressed and held in the setting (flashing) state, the number of laps can be changed quickly.
- Note:** If the number of laps is set to 0, the watch cannot be set to the stop mode by pressing the (R) button at the last lap (Auto stop function).
- Clearing of set value
If the (S) and (R) buttons are pressed at the same time, the set number of laps is cleared. The set value is kept, even if the watch is changed to another mode.

b. ■ Setting of distance of circuit

If the (M) button is pressed in the number-of-laps setting mode, the watch is set to the distance-of-circuit mode.

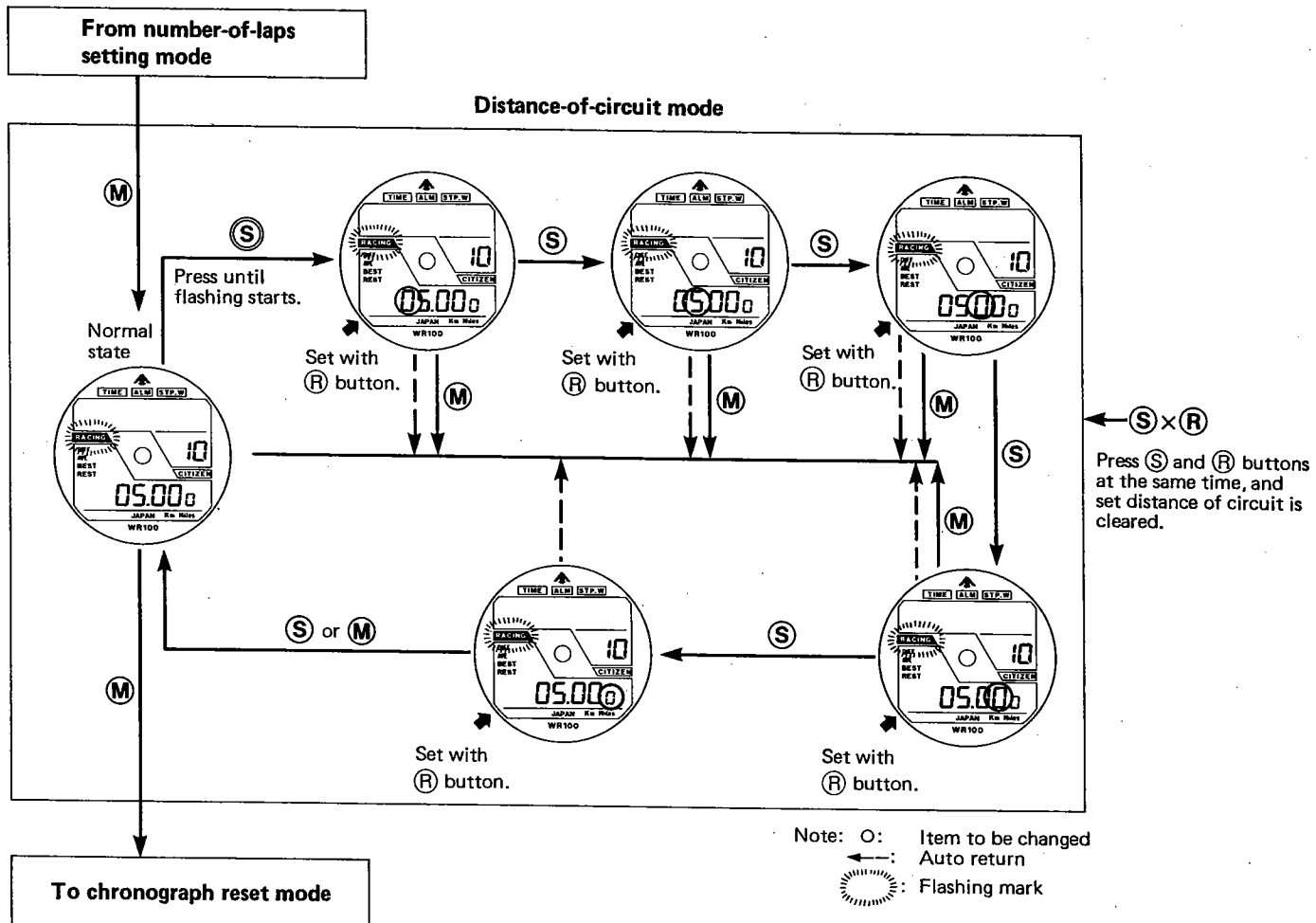

- Distance-of-circuit setting mode
If the (M) button is pressed in the number-of-laps setting mode, the watch is set to the distance-of-circuit mode. The distance of the circuit can be set in this mode. Set the distance of one turn of the circuit before the race is started. The setting range of distance of the circuit is form 0 to 99,999 km (mile), and the unit is 0.001.

- Setting of distance (by either km or mile)
Call the item to be changed with the (S) button and set the distance of the circuit with the (R) button. If the (R) button is pressed and held in the setting (flashing) state, the distance of the circuit can be changed quickly.
- Note:** If the distance of the circuit is set to 0, the watch indicates a bar when the speed is called in the chronograph run mode.
- Clearing of set value
Only the (S) and (R) buttons are pressed at the same time, the set distance of the circuit is cleared. The set value is kept, even if the watch is changed to another mode.

Common remarks on number-of-laps setting mode and distance-of-circuit setting

- Instant manual return
If the (M) button is pressed in any setting state, the watch is forcedly returned to the normal state of the setting mode of each mode.
- Auto return
If the watch is left in the setting state for about two minutes, the watch is automatically returned to the normal state of the number-of-laps setting mode.

c. ■ Measurement and indication of race data

Necessary information to the race can be indicated in the chronograph run mode and stop mode.

- If the (M) button is pressed in the distance-of-circuit setting mode, the watch is set to the chronograph reset mode.
- If the (M) button is pressed again in the chronograph reset mode, the watch is returned to the number-of-laps setting mode.

— Start operation —

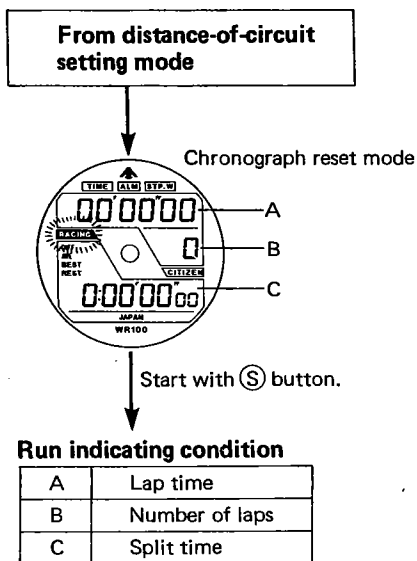

- If the (S) button is pressed in the chronograph reset mode, the watch starts chronograph measurement.

MEASURING RANGE

- Lap time: 00 minute 00 second 00/100 second to 59 minutes 59 seconds 99/100 seconds (Repeated)
- Number of laps: 0 to 199 (Repeated)
- Split time: 0 hour 00 minute 00 seconds 00/100 second to 99 hours 59 minutes 59 seconds 99/100 second (Repeated)

* Operations stop when the number of laps set is completed

(Lap time measurement and indication)

If the $\text{\textcircled{R}}$ button is pressed in the RUN indication mode, the lap time is indicated. (The watch is returned to the Run indication mode after the lap time is indicated for 15 seconds.)

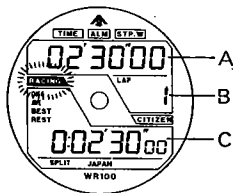

• Indicated items

- Indicator A: Lap time
- Indicator B: Number of laps (measured after start)
- Indicator C: Split time

If the $\text{\textcircled{R}}$ button is pressed while the lap time is indicated, a new lap time is indicated and the number of laps is increased.

Calling the data during race

(When the racer is running the fifth lap in the race to cover 10 laps of a 5-km circuit)

Precautions

- Data cannot be called during a race when the lap time is not being measured (when indicator B indicates 0).
- About 15 seconds after a data is called during a race, the watch is automatically returned to the RUN indication mode (by auto return function). To check that data again, press the $\text{\textcircled{M}}$ button again to call it.

(Indication of latest lap time)

If the $\text{\textcircled{M}}$ button is pressed in the run indication state, the latest lap time is indicated. In this mode, the previous lap time and split time can be checked.

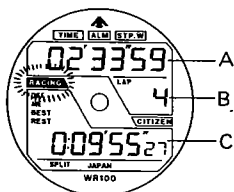

• Indicated items

- Indicator A: Latest lap time (Forth lap time)
- Indicator B: Latest number of laps covered (4)
- Indicator C: Latest split time (Time up to fourth lap)

$\text{\textcircled{M}}$

(Indication of lap time difference)

If the (M) button is pressed in the lap time indication state or the latest lap time indication state, the lap time difference is indicated. In this mode, the latest lap time can be compared with the previous one.

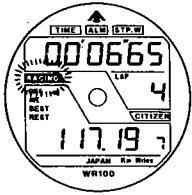

• Indicated items

- Indicator A: Lap time difference (between third and fourth lap times)
- Indicator B: Number of laps (4)
- Indicator C: Lap speed (Bar is indicated when speed exceeds 1000 km/h)



(Indication of average lap time)

If the (M) button is pressed in the lap time difference indication state, the average lap time is indicated. In this case, the average of the fourth, third, second, and first lap times is indicated.

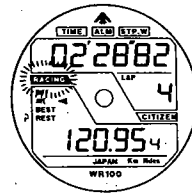

• Indicated items

- Indicator A: Average lap time (Bar is indicated when lap time exceeds 60 minutes)
- Indicator B: Number of laps (4)
- Indicator C: Average speed (Bar is indicated when bar is indicated as average lap time)



(Indication of shortest lap time)

If the (M) button is pressed in the average lap time indication state, the shortest lap time is indicated. In this mode, the shortest lap time can be checked.

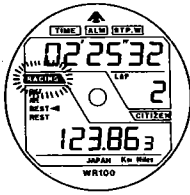

• Indicated items

- Indicator A: Shortest lap time
- Indicator B: Turn in which highest speed (shortest lap) was recorded
- Indicator C: Highest lap speed (Speed at shortest lap time)



(Indication of number of laps to be covered further)

If the (M) button is pressed in the shortest lap time indication state, the number of laps to be covered further is indicated. In this mode, the number of laps and distance to be covered further can be checked.

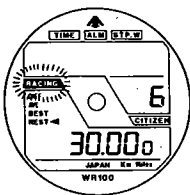

• Indicated items

- Indicator A: Nothing is indicated.
- Indicator B: Number of laps to be covered further
- Indicator C: Distance to be covered further



(Indication of difference between two racers)

(See the next section "Measurement of difference between two racers")

If the (M) button is pressed while the number of the laps to be covered further is indicated, the difference between two racers is indicated. In this mode, the time difference from a rival can be checked.

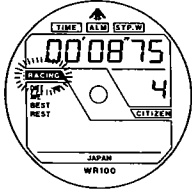

● Indicated items

Indicator A: Difference in split time (Indicated only when difference between two racers is measured)

Indicator B: Number of laps (4)

Indicator C: Nothing is indicated.

(Changing to run indication state)

If the (M) button is pressed while the difference between two racers is indicated, the watch is set to the run indication state.

(Auto return)

If the watch is left unoperated for about 15 seconds in any mode of the latest lap time indication, lap time difference indication, average lap time indication, shortest lap time indication, indication of number of laps to be covered further, and indication between two racers, the watch is returned to the run indication state.

Measurement of difference between two racers

If the (S) button is pressed in the chronograph run mode (to measure the difference of split time between two racers), the split time at this time is stored, and the time difference from a rival can be checked.

Example 1: Measurement of split time difference from a following racer.

Press the (R) button when your car passes the measurement point, and press the (S) button when the rival passes the measuring point. The time difference between the two racers at the measuring point can be indicated by the above explained operation to indicate difference between two racers.

Example 2: Measurement of split time difference from a preceding racer

Press the (S) button when the rival passes the measurement point, and press the (R) button when your car passes the measuring point. In this case, a minus mark is added to the a time difference between them.

Cancellation of lap time measurement

If the lap time measurement is started by mistake, press and hold the **(S)** button for about two seconds while the lap time is indicated (for about 15 seconds), and the latest lap time is canceled, then the watch is returned to the RUN indication state and the number of the laps is returned to the previous time. At the same time, the previous operation of difference between two racers is canceled.

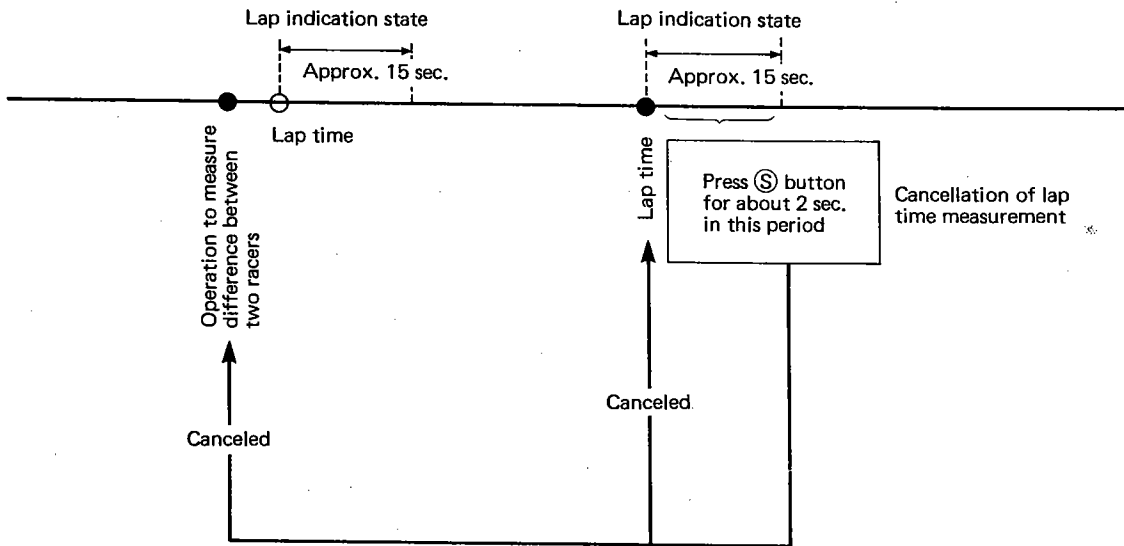

d. — Goal operation —

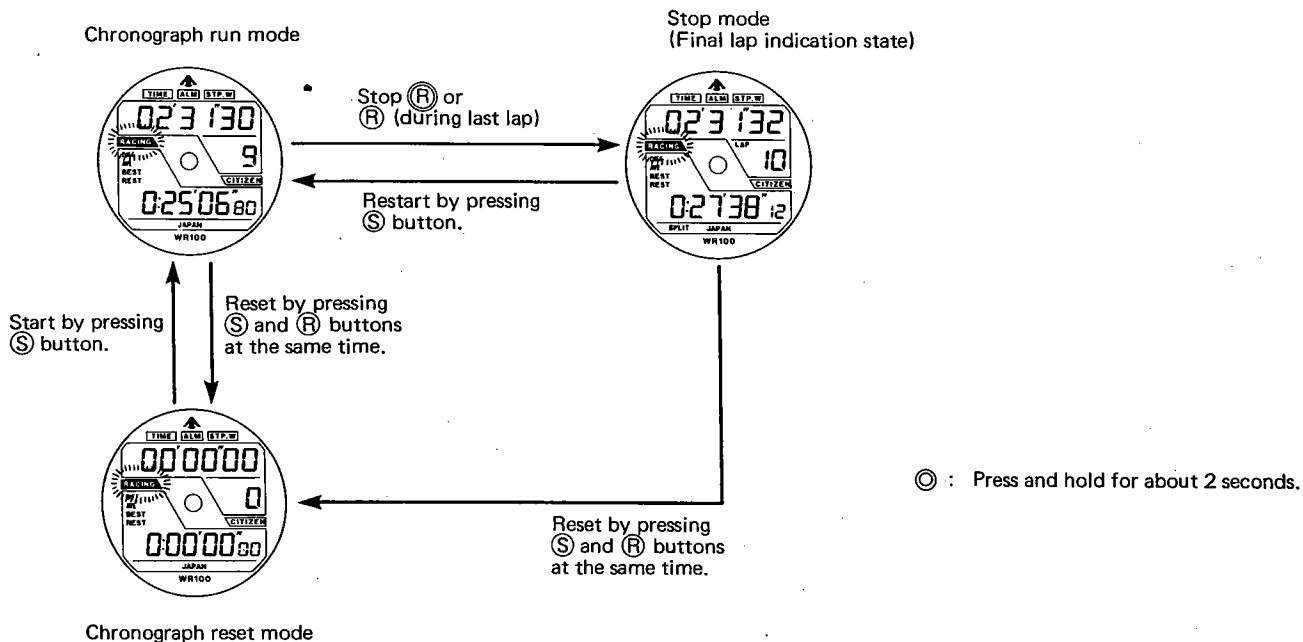

(Stop mode)

When the set number of laps is covered in the chronograph run mode, if the lap time is measured by pressing the (R) button, the watch is set to the stop mode (for indication of final lap time). Even if the set number of laps has not been covered, if the (R) button is pressed for about two seconds, the watch is set to the stop mode.

If the watch is set to the stop mode, the lap time, split time and number of laps covered at this time are used as the final data.

(Calling the record in stop mode)

If the watch is set to the stop mode, the final lap time is indicated. In this condition, the following items are indicated repeatedly in order every time the (M) button is pressed.

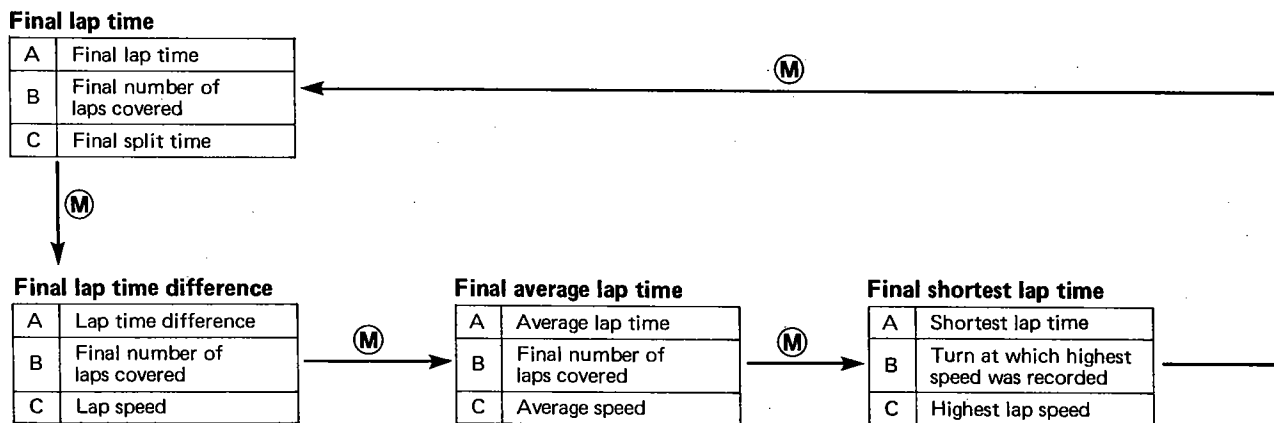

(Restart operation)

If the (S) button is pressed in the stop mode, the watch is restarted, and it starts the measurement.

(Resetting operation)

If the (S) and (R) buttons are pressed at the same time in the chronograph run mode or stop mode, the measured data are reset.

* The values set in the setting mode (number of laps and distance of circuit) are maintained.

e. ■ Flow of operation in racing mode

The above operation is summarized below.

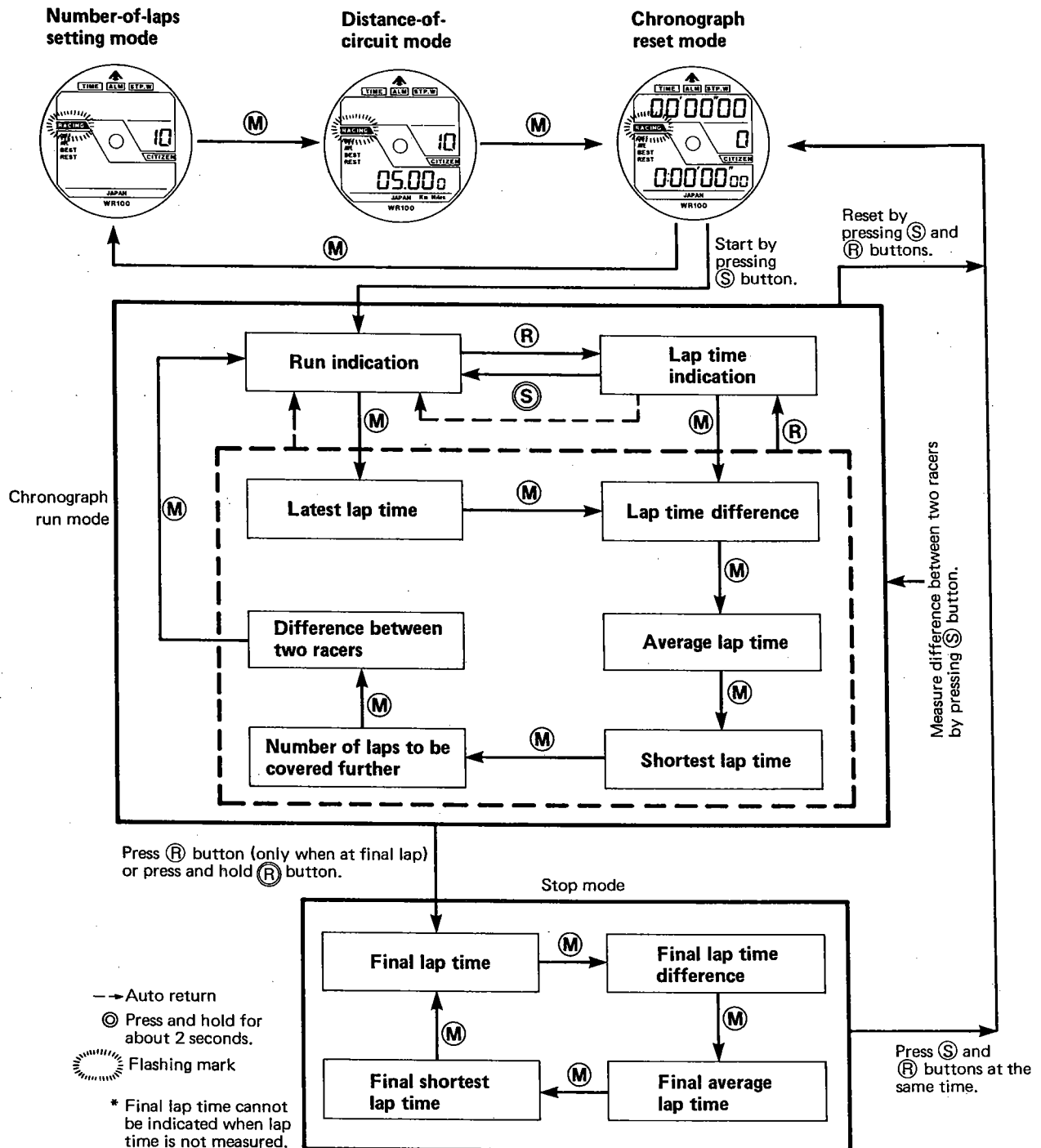

3-3 OPERATING METHOD CAL C080 (Pilot)

§1 Name of Each Part

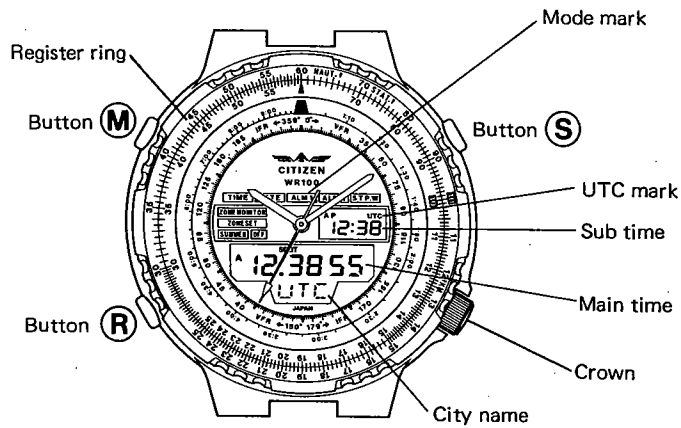

Analog Section

SETTING THE TIME

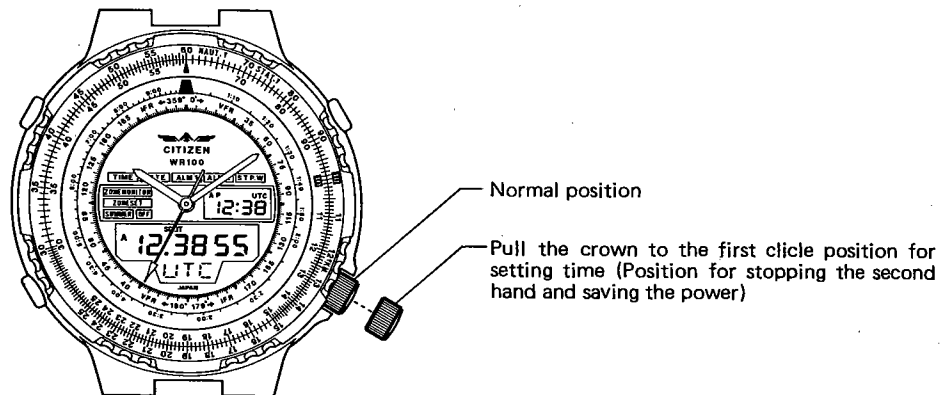

- The digital and analog sections can be set independently from each other.
- Set the time with the crown pulled by one click, similarly to a common analog watch.
- After the time is set securely return the crown to its normal position.

§2 Digital Section

CHANGING THE INDICATION

This watch is ^{CHANGED} set to each mode according to the following order.

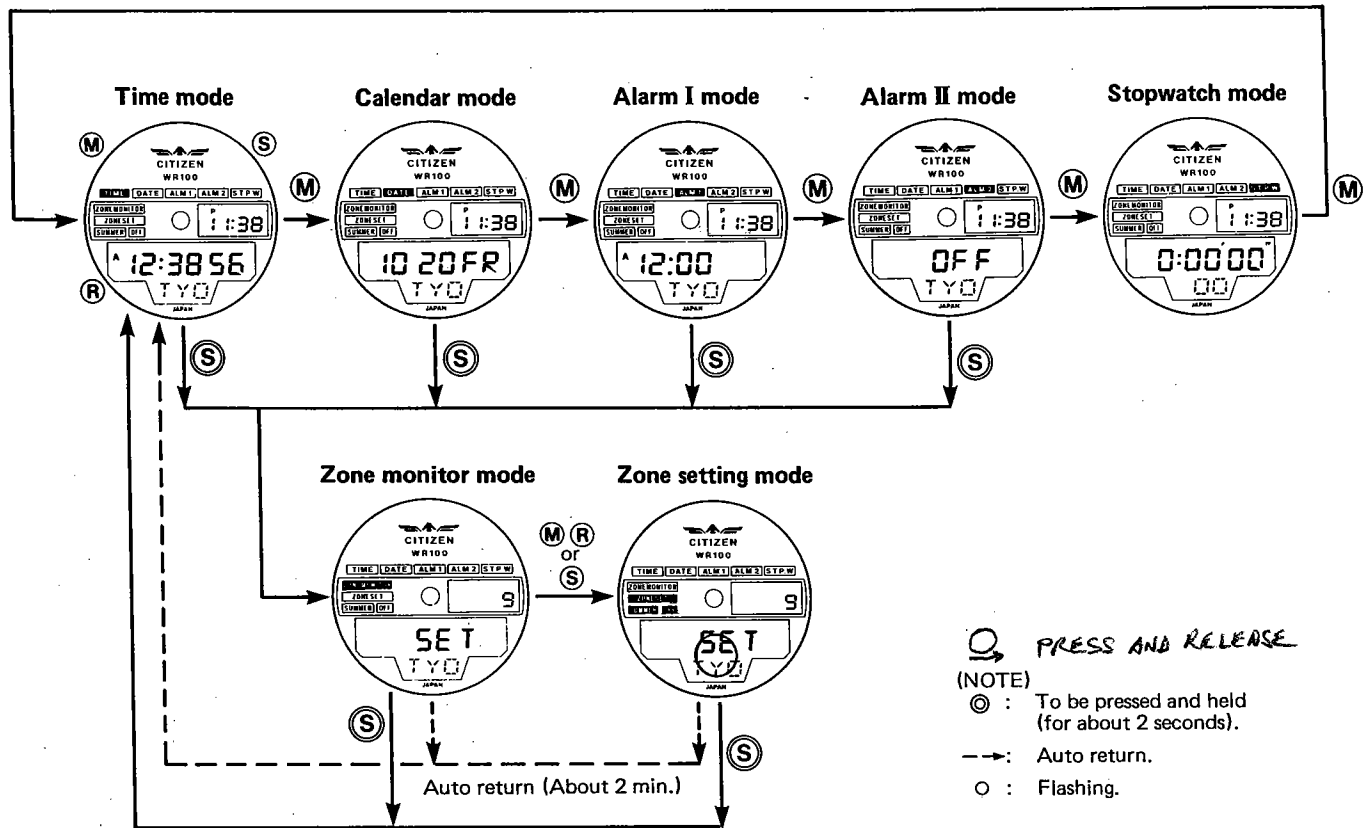

(Changing the mode)

If the (M) button is pressed in the time, calendar, alarm I, alarm II and stopwatch mode, the watch is set to the next mode.

(Changing to zone monitor mode)

If the (S) button is pressed and held for about two seconds in the time, calendar, alarm I and alarm II mode, the watch is set to the zone monitor mode.

(Changing to zone setting mode)

If the (M), (R) or (S) button is pressed in the zone monitor mode, the watch is set to the zone setting mode.

* If the (S) button is pressed and held for about two seconds in the zone monitor or zone setting mode, the watch is ^{RETURNED} set to the time mode.

(Auto return)

If the watch is left untouched for more than two minutes in the zone monitor or zone setting mode, the watch is automatically returned to the time mode.

a. HOW TO USE ZONE MONITOR MODE

(DAY LIGHT SAVING)

In this mode, the SET/OFF condition of the normal time and summer time of all the (31) cities can be confirmed. (The setting of each city is indicated for two seconds, then it is automatically changed to that of the next city.) The "next city" means the next city shown in the following table.

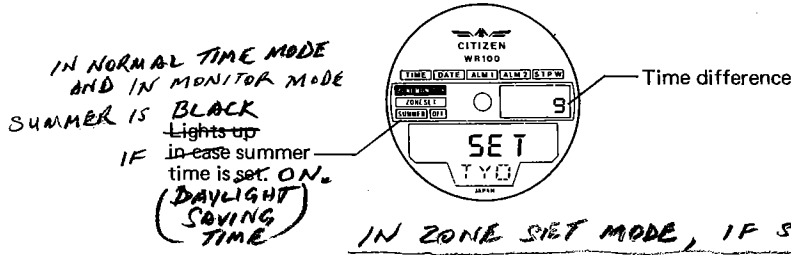

IN ZONE SET MODE, IF SUMMER IS ON, SUMMER IS BLACK AND OFF IS CLEAR, " " " " " " " " OFF " " AND OFF IS BLACK.

Time difference between indicated city and Greenwich.

City	Time difference
UTC (Greenwich)	±0
LON (London)	
PAR (Paris)	+1
ROM (Rome)	
CAI (Cairo)	+2
IST (Istanbul)	
MOW (Moscow)	+3
KWI (Kuwait)	
DXB (Dubai)	+4
KHI (Karachi)	+5
DEL (New Delhi)	+5.5
DAC (Dacca)	+6
BKK (Bangkok)	+7
SIN (Singapore)	
HKG (Hong Kong)	+8
PEK (Peking)	
TYO (Tokyo)	+9
SYD (Sydney)	+10
NOU (Noumea)	+11
AKL (Oakland)	+12
HNL (Honolulu)	-10
ANC (Anchorage)	-9
LAX (Los Angels)	-8
DEN (Denver)	-7
CHI (Chicago)	-6
MEX (Mexico City)	
NYC (New York)	-5
YUL (Montreal)	
CCS (Caracas)	-4
RIO (Rio de Janeiro)	-3
BUE (Buenos Aires)	

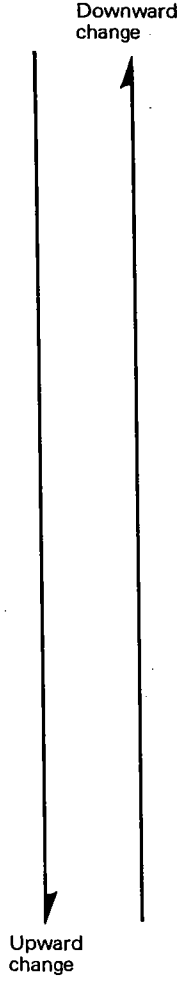

Returns from BUE to UTC

b. HOW TO USE ZONE SETTING MODE

In this mode, indication of the normal time and summer time in all the cities can be set.

(Change of cities to be indicated)

- If the (S) button is pressed in the zone setting mode, the next city can be selected (Upward change).
- If the (R) button is pressed and held for about two seconds in the zone setting mode, the previous city can be selected (Downward change). *BUT WILL CHANGE SUMMER TIME ON OR OFF.*

(Setting the summer time)

- Every time the (R) button is pressed ^{WHILE} in the zone setting mode, the summer ^{TURNED ON OR} time is ~~set~~ and turned off.
 - * If the summer time is set, the time of the indicated city is advanced by one hour.

(Selecting the cities to be indicated) *IN NORMAL TIME MODE.*

- Every time the (M) button is pressed in the zone setting mode, setting of the indicated cities is changed. The contents of the upward and downward changes are set by this procedure. (Only the set cities are looped and indicated.) *IF DISPLAY SHOWS "OFF" IN PLACE OF "SET", THAT CITY WILL NOT BE DISPLAYED*

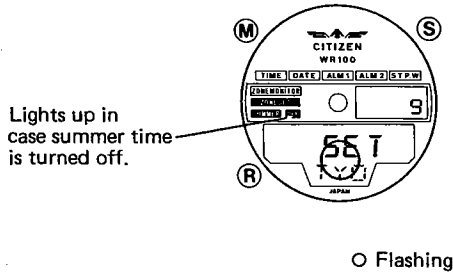

If (S) button is pressed, indicated city is changed to the next upper one.

If (R) button is pressed and held for about two seconds, indicated city is changed quickly to the next lower one.

If (R) button is pressed, the summer time is set or turned off.

If the (M) button is pressed, the indicated city is set or turned off.

Example: Procedure to select and set UTC, PAR, TYO, NYC and RIO and to turn off all other cities.

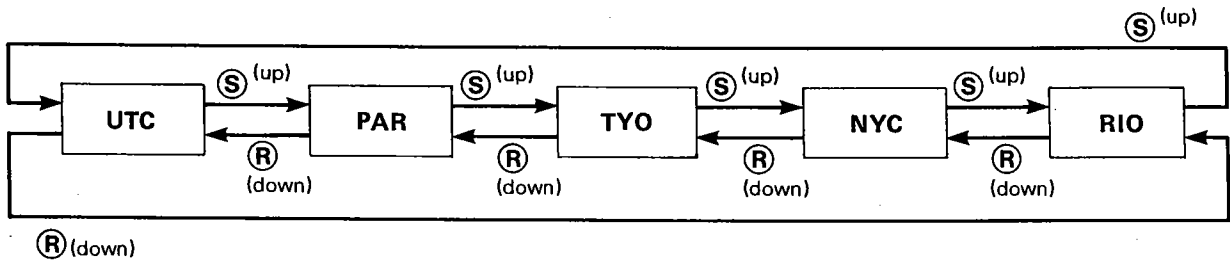

c. HOW TO USE TIME MODE

In this mode, the times of two cities (main time and sub time) are indicated.

SETTING THE TIME

Select the item to be set by pressing and holding the (M) button for about two seconds, then set it with the (R) button. While the minute or hour is being changed, if the (R) button is pressed for about two seconds, it is changed quickly.

In the normal state,

If (S) button is pressed, next upper city is selected.

If (R) button is pressed, next lower city is selected.

If (S) and (R) buttons are pressed at the same time, main and sub time are interchanged with each other.

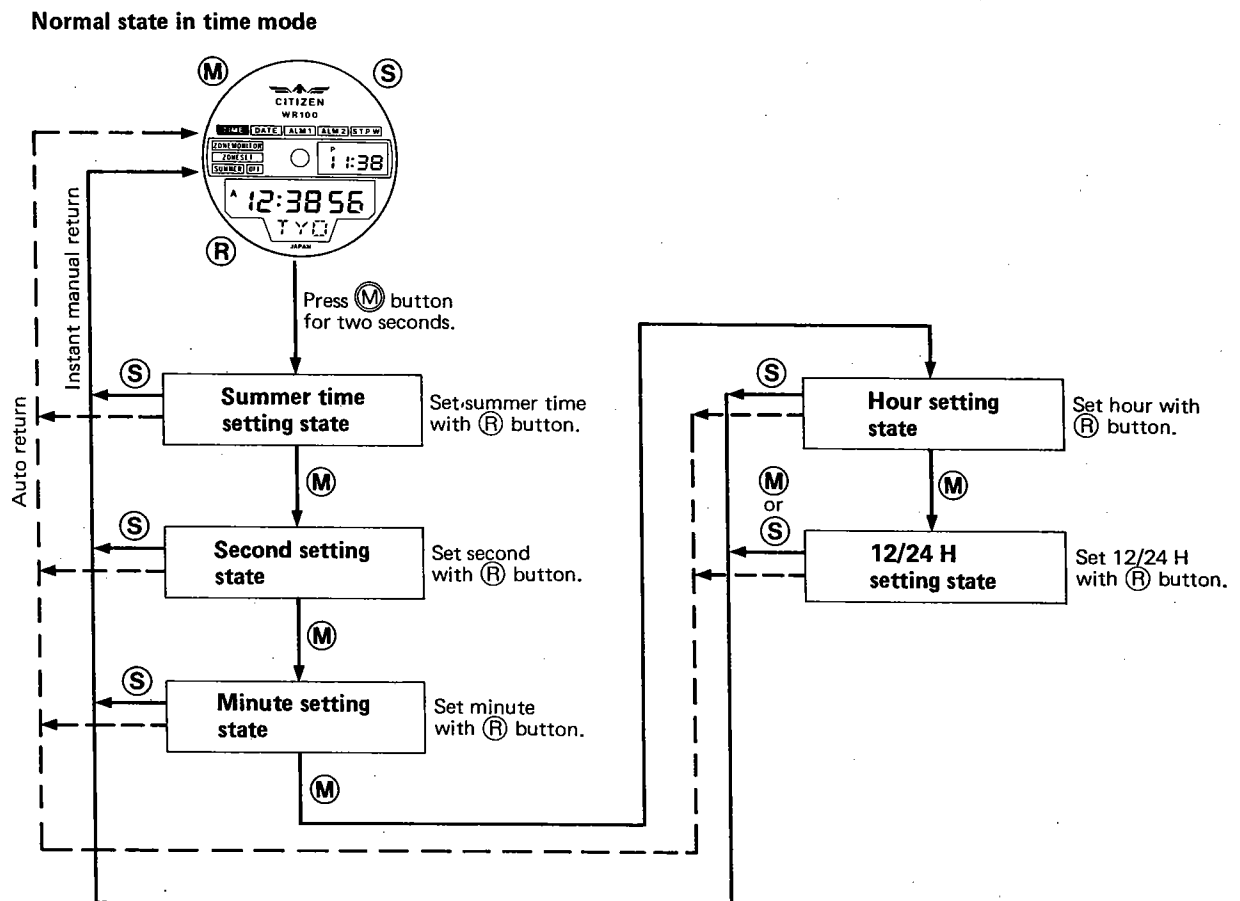

(Auto return)

If the watch is left unoperated for about two minutes in the setting state, it is returned to the normal state.

(Instant manual return)

If the (S) button is pressed in any setting state, the watch is returned to the normal state.

e. HOW TO USE ALARM I MODE (Common to alarm II mode)

SETTING THE ALARM I

Referring to the section of setting the time, operate the buttons.

(Note)

- The 12/24H system is set for the time and calendar modes.
- The alarm sounds for about 20 seconds. It can be stopped by pressing any button.

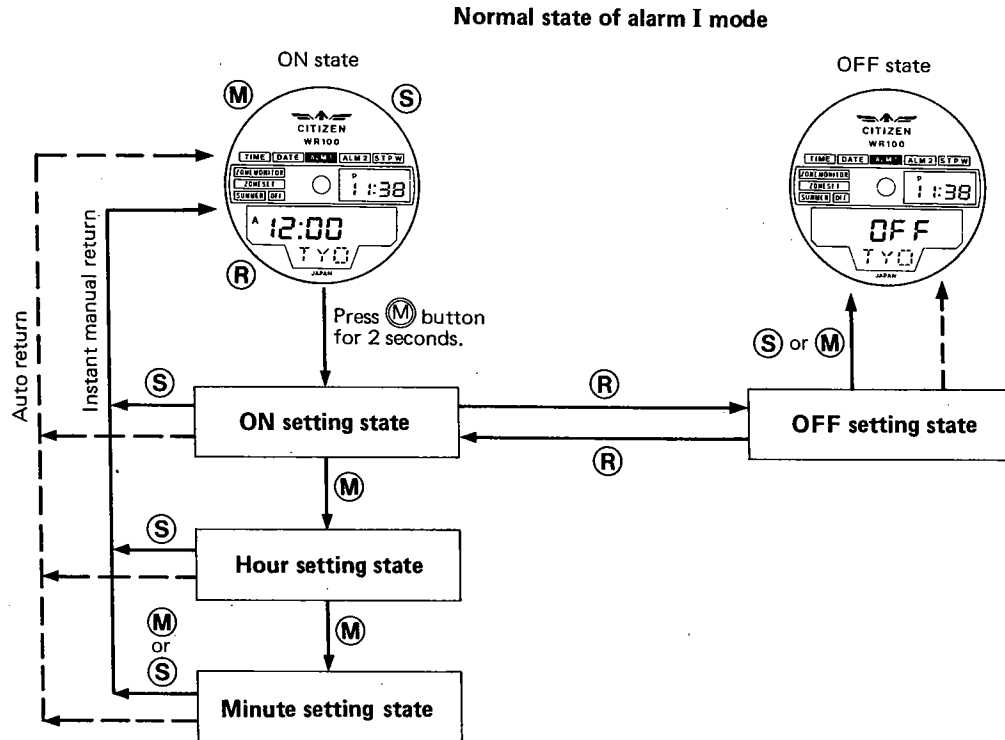

In the normal state,

If (S) button is pressed,

Next upper city is indicated (and set time of alarm I is changed for that city).

If (R) button is pressed,

Next lower city is indicated (and set time of alarm I is changed for that city).

(Changing the cities to be indicated)

If the (S) button is pressed in the normal state, the next city is indicated (Upward change). If the (R) button is pressed, the previous city is indicated (Downward change). As the indicated city is changed, the main time is automatically changed to the time of the new city.

(Lighting up of UTC mark)

If UTC is selected as the city for the sub time, UTC mark lights up.

(Interchange between main and sub times)

If the (S) and (R) buttons are pressed at the same time in the normal state, the main time and sub time are interchanged with each other.

d. HOW TO USE CALENDAR MODE

In this mode, the calendar of the main time is indicated.

SETTING THE CALENDAR

Referring to the section of setting the time, operate the buttons.

(Note)

- The year can be set to 1989 – 2004. It is not necessary to adjust the end of each month in this period.
* The year is indicated only in the setting state.
- If an unexisting date is set, the first of the next month will be indicated automatically when the watch is set to the normal state.
- The day of the week is automatically set after the year, month and date are set.

Normal state in calendar mode

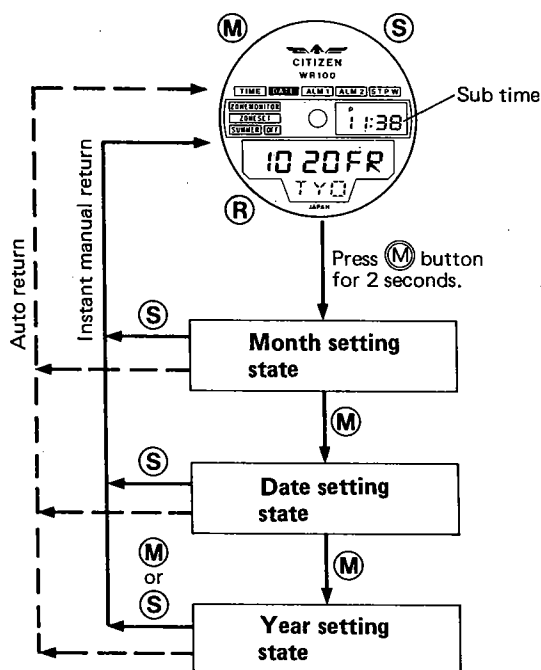

In the normal state,

If (S) button is pressed, next upper city is indicated (and calendar is changed for that city).

If (R) button is pressed, next lower city is indicated (and calendar is changed for that city).

If (S) and (R) buttons are pressed at the same time, main and sub times are interchanged with each other (and calendar is changed for main time).

f. HOW TO USE STOP WATCH MODE

Operate this watch as a stopwatch with the (R) and (S) buttons.
(A confirmation sound comes out each time these buttons are pressed.)

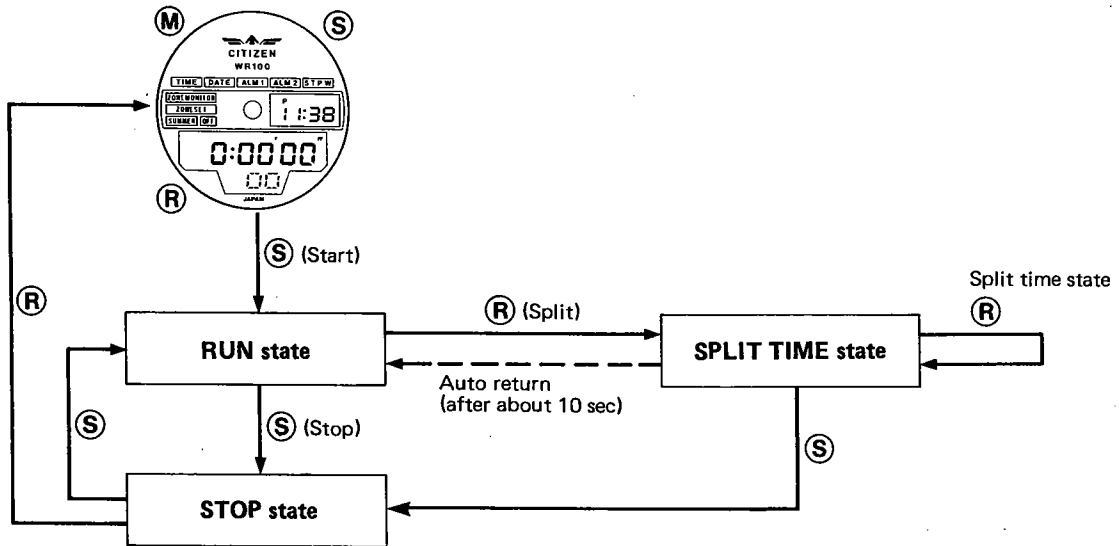

- The stopwatch works in 24-hour system (and can measure time from 00 minute, 00 second 10/100 second to 23 hours, 59 minutes, 59 seconds 99/100 seconds). After 23 hours, 59 minutes, 59 seconds 99/100 seconds, the measurement is repeated from 00 minute 00 second 00/100 second.

§3 Calculating Function

USING THE CALCULATION FUNCTION

<Names of scales and marks>

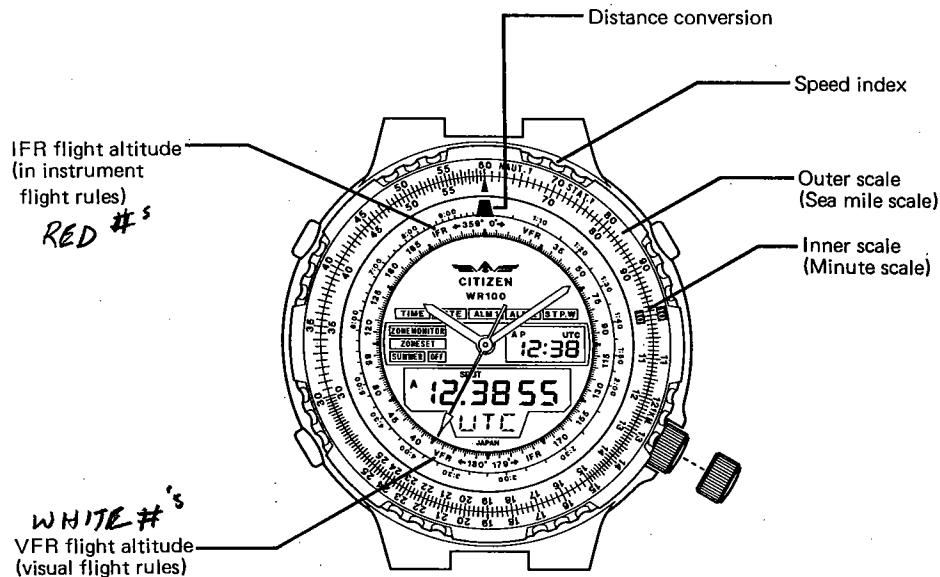

CALCULATING FUNCTION

When using the calculating function of this watch, observe the following.

- Use the results of the calculation by this watch for reference only.
- The user cannot determine the position of the unit with the scale of this watch.

1. Function of calculating the navigation

1) Calculation of required time

(Example)

How long does it take to fly 450 sea miles at the speed of 180 kt?

(Answer)

Set the 18 point of the outer scale to the SPEED INDEX (▲) of the inner scale, and the point of the inner scale (2:30) corresponding to the 45 of the outer scale is the time required (2 hours and 30 minutes).

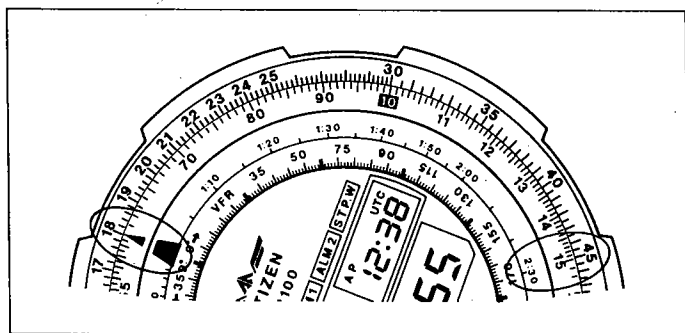

2. General calculation function

1) Multiplication

(Example)

$$20 \times 15 \text{ (10g25 + 10g15)}$$

Set the 20 point of the outer scale to the **10** point of the inner scale. Read the 30 point of the outer scale corresponding to the 15 point of the inner scale. Determine the point of the unit and obtain 300.

Note that the point of the unit of the result cannot be determined with this scale.

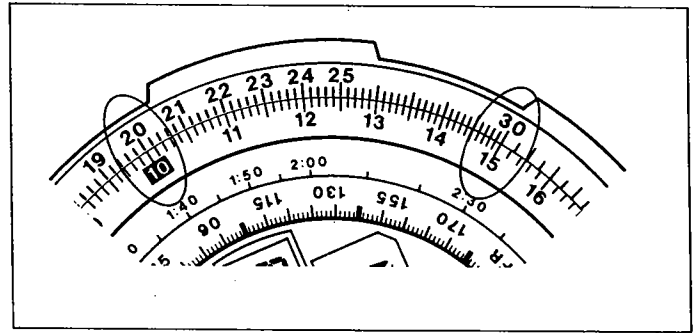

2) Division

(Example)

$$250 \div 20 \text{ (10g250 - 10g20)}$$

Set the 25 point of the outer scale to the 20 point of the inner scale. Read the 12.5 point of the outer scale corresponding to the **10** point of the inner scale. Determine the point of the unit and obtain 12.5.

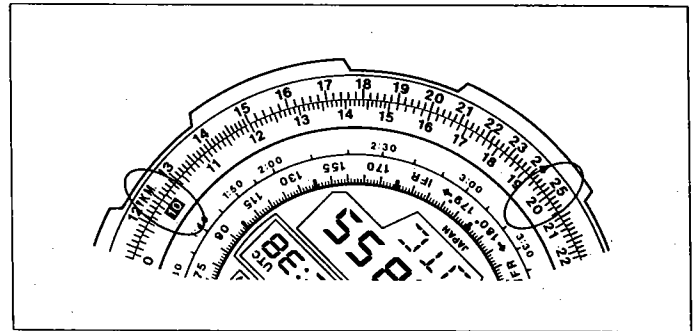

● How to read the flight altitude in VFR (visual flight rules) and IFR (instrument flight rules)

● Flight altitude in VFR (white figures)

When the airplane flies in the direction of $0^\circ - 179^\circ$, the flight altitude is 1000 feet x Odd number of 500 feet.

When the airplane flies in the direction of $180^\circ - 359^\circ$, the flight altitude is 1000 feet x Even number of 500 feet.

That is, when the airplane flies from Osaka to Tokyo, its flight altitude is increased to 3500 feet, 5500 feet, 7500 feet, ---- in order. When it flies from Osaka to Fukuoka, its flight altitude is increased to 4500 feet, 6500 feet, 8500 feet, ----.

● Flight altitude in IFR (Red figures)

When the airplane flies in the direction of $0^\circ - 179^\circ$, the flight altitude is 1000 feet x Odd number feet.

When the airplane flies in the direction of $180^\circ - 359^\circ$, the flight altitude is 1000 feet x Even number feet.

* The flight altitudes of the airplanes are determined according to their flying methods and directions as shown above to prevent an in-flight collision.

2) Calculation of flight distance

(Example)

What is the flight distance when the speed is 210 kt and the flight time is 40 minutes?

(Answer)

Set the 21 point of the outer scale to the speed index (▲) of the inner scale, and the 14 (140 sea miles) corresponding to the 40 point of the inner scale is obtained.

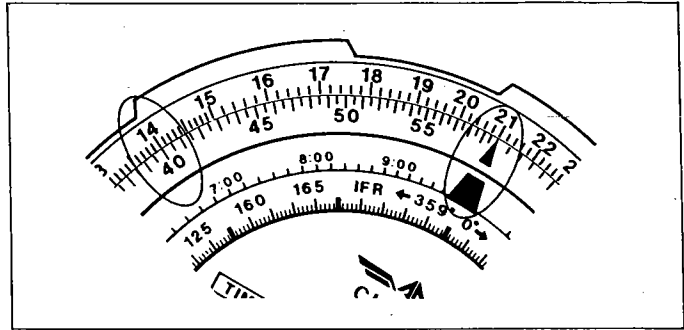

3) Calculation of fuel consumption ratio

(Example)

How is the fuel consumption ratio when the flight time is 30 minutes and 120 gallons of the fuel is consumed?

(Answer)

Set the 12 point of the outer scale to the 30 point of the inner scale, and the 24 (42 gallons/hour) point corresponding to the speed index (▲) is obtained.

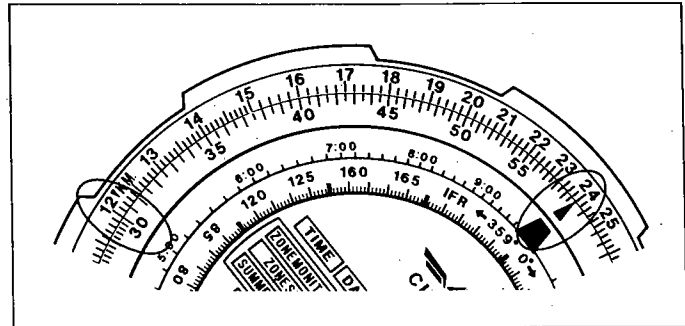

4) Calculation of quantity of consumed fuel

(Example)

How much fuel is consumed when the fuel consumption ratio is 250 gallons/h and the flight time is 6 hours?

(Answer)

Set the 25 point of the outer scale to the speed index (▲) of the inner scale, and the 15 (1500 gallons) corresponding to 6:00 is obtained.

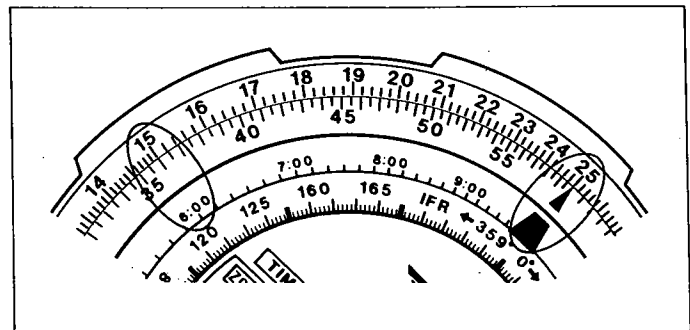

5) Calculation of how long the airplane can fly

(Example)

How long the airplane can fly when the fuel consumption ratio is 220 gallons/h and 550 gallons of the fuel can be consumed?

(Answer)

Set the 22 point of the outer scale to the speed index (▲) of the inner scale, and the 2:30 point (2 hours and 30 minutes) corresponding to the 55 point of the outer scale is obtained.

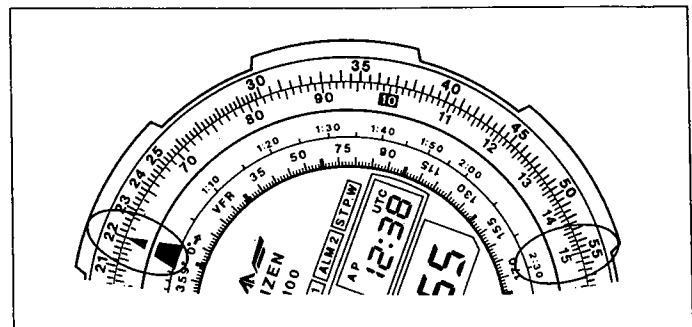

5 DISASSEMBLE AND ASSEMBLE OF MODULE

CAL C050, C070, C080

Disassemble the parts in order of ① - ③⑥.
Assemble the parts in order of ③⑥ - ①.

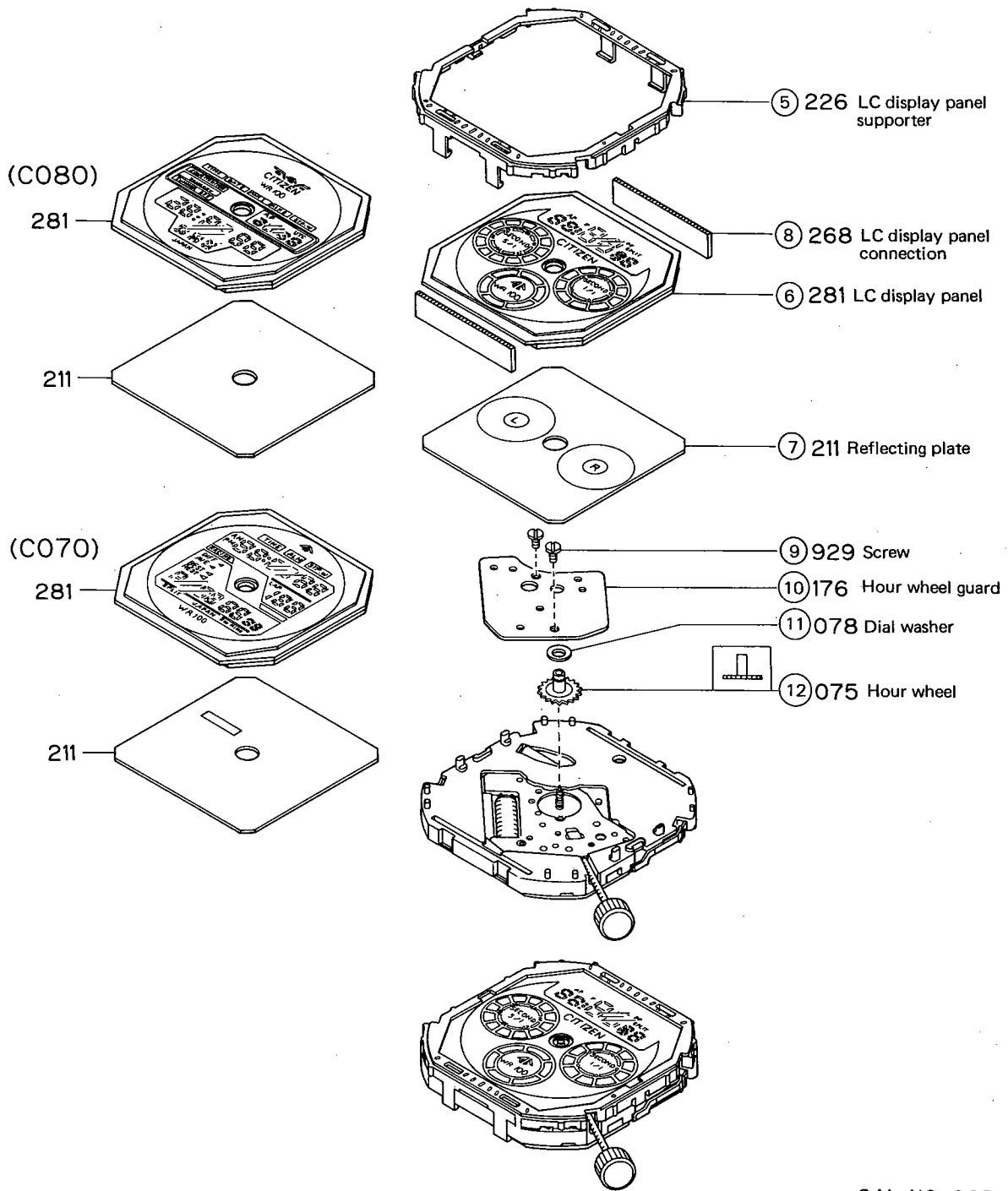

CAL NO. C050
(C070, C080)

4 PRECAUTIONS FOR DISASSEMBLE AND ASSEMBLE OF MODULE

1. Precaution for replacing the power cell

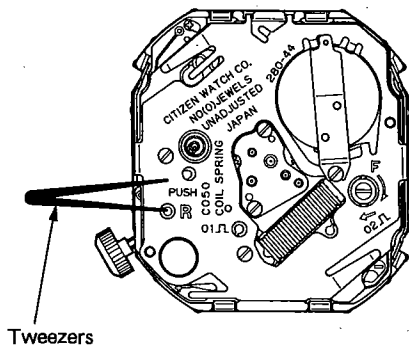

After the power cell is replaced, short-circuit the (R) part to the circuit unit supporter for the characteristic reason of the microcomputer IC.

2. Handling of circuit unit supporter

When installing the circuit unit supporter, set the hook and switch spring to the specified positions of the supporter for plate complete.

3. Unit of electronic circuit

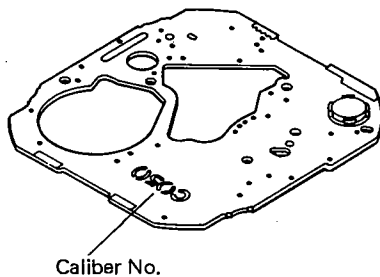

Confirm the caliber No. printed on the circuit.

● Lubrication marks

	: A lube
	: V lube
	: F lube
	: CH-1

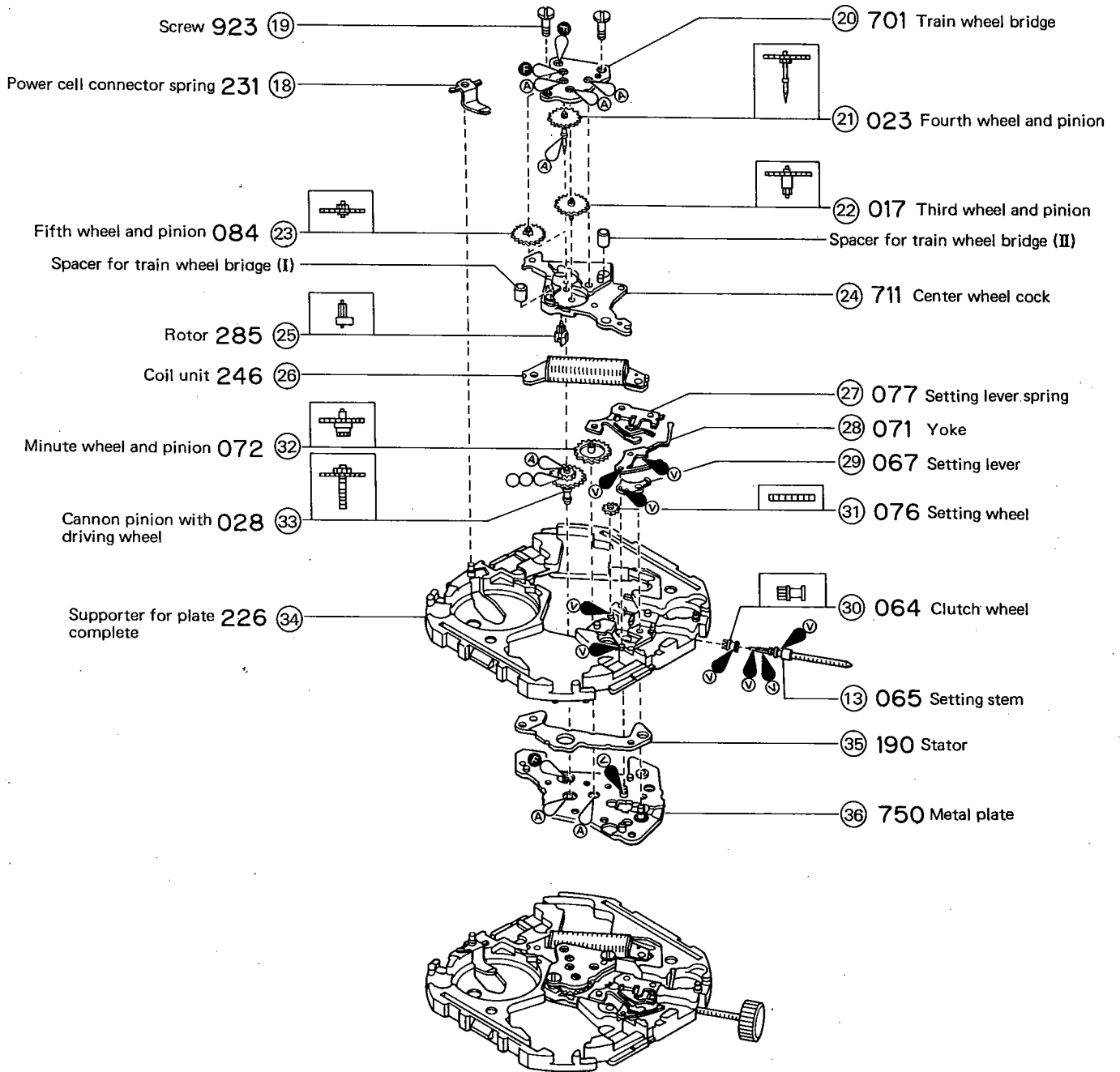

* Spacers (I) and (II) for train wheel bridge are the set parts of the center wheel cock.

CAL NO. C050
(C070, C080)

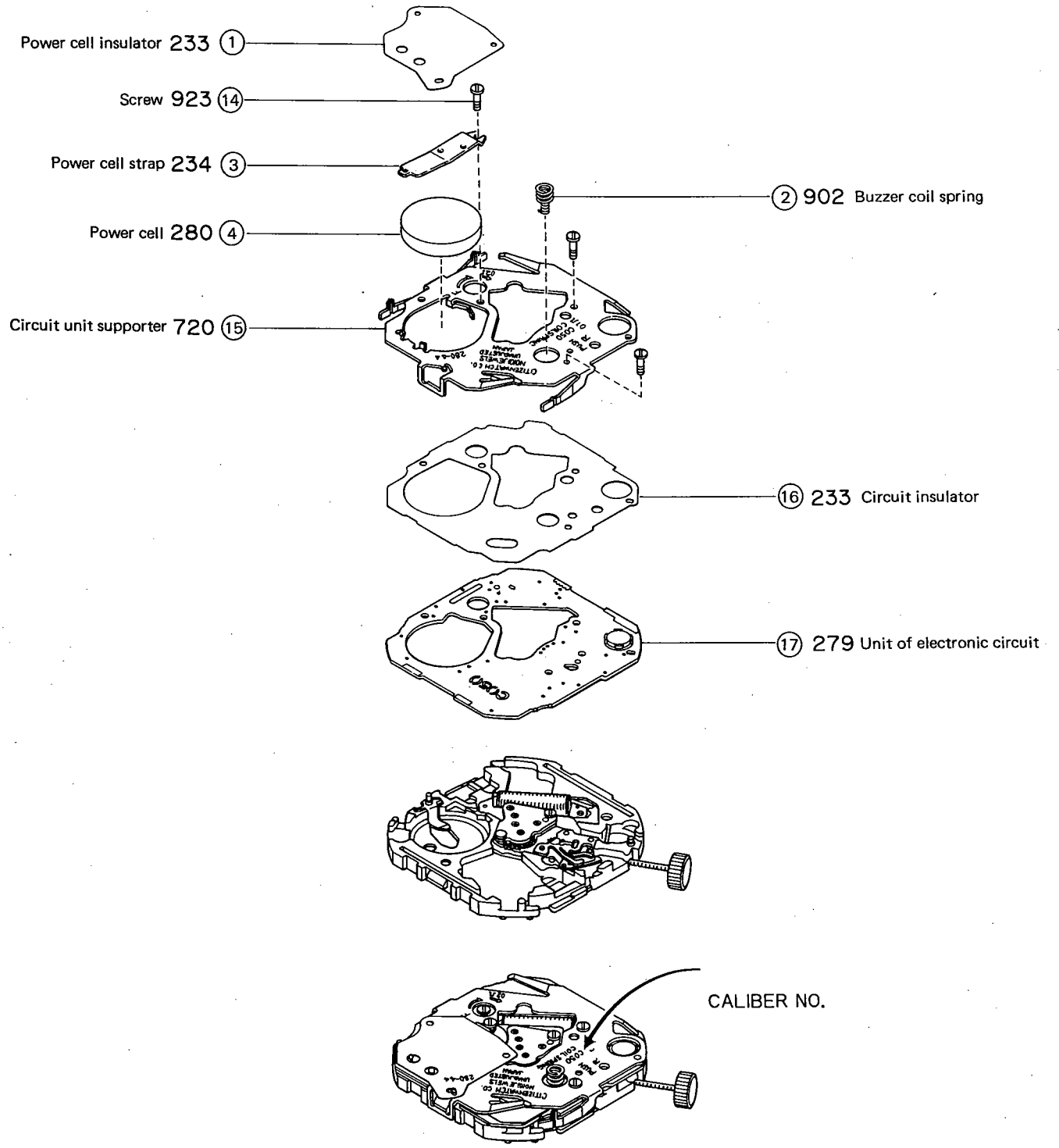

CAL NO. C050
(C070, C080)

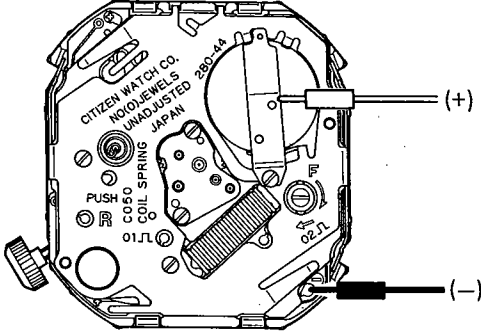
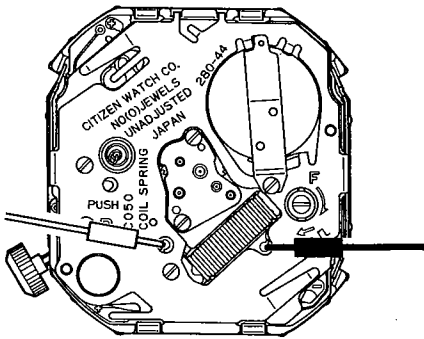
Check points	How to check	Results & treatment
<p>1 Measurement of power cell voltage</p>	<p>[Refer to Technical Manual Basic Course II-1-a]</p> <p style="text-align: center;"><Tester range: DC 12V></p> 	<ul style="list-style-type: none"> ● Over 1.5V → Normal ● Under 1.5V → Replace the power cell.
<p>2 Check of output signals</p>	<p>[Refer to Technical Manual Basic Course II-1-b]</p> <p style="text-align: center;"><Tester range: DC 0.3V></p>  <p style="text-align: center;">(The tester lead pins have no polarity.)</p>	<ul style="list-style-type: none"> ● The tester pointer swings every 1 second. → Normal ● The tester pointer does not swing. → Check the connections parts ● The connections are normal. → Replace the electronic circuit unit.
<p>3 Check of LC display panel and connection part</p>	<p>[Refer to the Digital Section of Technical Manual Basic Course II-2-a]</p> <ul style="list-style-type: none"> ● Inspection of all segments (Press the (M), (S) and (R) buttons at the same time to turn on all the segments, and check for defective ones. ● Continuity test on LC display panel, cell connection rubber and plate complete Check the parts for stain, breakage, etc. 	<ul style="list-style-type: none"> ● LC display panel, connection rubber or metal plate is not installed correctly. → Install correctly ● Parts are stained or dirty. → Remove stain and dirt. ● Parts are cut, broken or scratched. → Replace parts.
<p>4 Check of connection part</p>	<p>[Refer to Analog Section of Technical Manual Basic Course II-2-a]</p>	

6 INSPECTION AND ADJUSTMENT METHOD OF MODULE

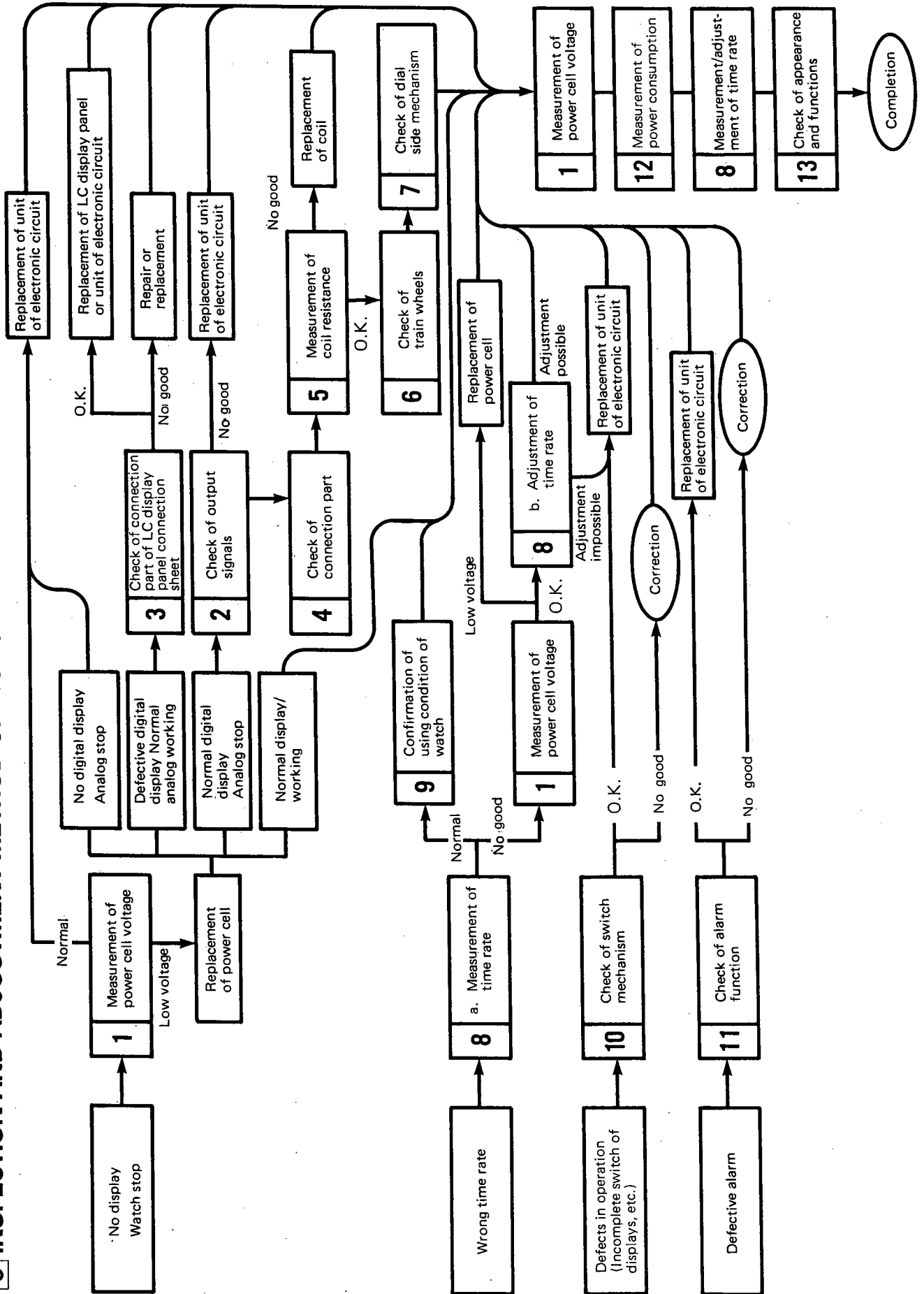

Check points	How to check	Results & treatment
<p>10 Check of switch mechanism</p>	<p>1. Inspection of movement.</p> <ul style="list-style-type: none"> ● Press the switch return spring with tweezers, etc. to contact it to plate complete, and confirm the switching function. ● Check for removal of pattern of electronic circuit unit, deformation of switch return spring, etc. <p>2. Inspection of push button</p> <ul style="list-style-type: none"> ● Check push button for deformation, stain, etc. <div data-bbox="483 493 1089 640" style="border: 1px solid black; padding: 5px;"> <p>(Note) Be sure to apply silicone oil to the packing of push button for waterproofness and smooth operation. Apply it to the packing of the sensor, too.</p> </div>	<ul style="list-style-type: none"> ● Switching function is normal. → Inspect push button. ● Pattern is removed or deformed. → Replace defective parts. ● Push button is stained or deformed. → Remove stain, or replace push button.
<p>11 Check of alarm mechanism</p>	<p>[Refer to Technical Manual Basic Course II-1-d]</p> <p>*1. Set the module in the case, and check output of alarm with the case back removed.</p> <p>(1) Set the watch in alarm mode.</p> <p>(2) Apply ⊕ lead pin to power cell surface and ⊖ lead pin to buzzer contact spring, then press ⊕ button.</p> <p style="text-align: center;"><Tester range: DC 0.3V></p> <div data-bbox="516 1304 1089 1640" style="text-align: center;"> </div> <p>*2. If the output of alarm is normal, perform the following inspection.</p> <ul style="list-style-type: none"> ● Check the piezo-electric element of vibrating plate for cracks and breakage. ● Check the buzzer contact spring for bend and deformation. ● Check the pattern of electronic circuit unit for dust and stain. 	<ul style="list-style-type: none"> ● Tester pointer does not swing. → Replace the electronic circuit unit <p style="text-align: center;">⇩</p> <ul style="list-style-type: none"> ● Tester pointer swings. → Normal <p style="text-align: center;">⇩</p> <ul style="list-style-type: none"> ● Perform inspection in *2. <p style="text-align: center;">⇩</p> <p>Normal indication. → O.K.</p>

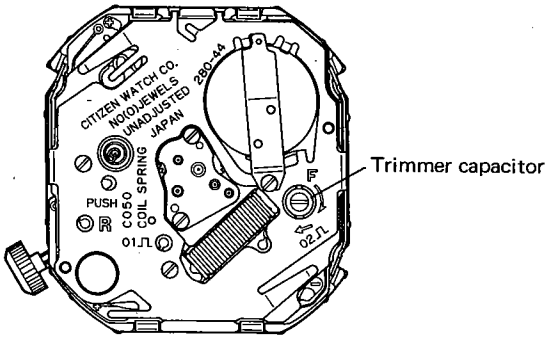
Check points	How to check	Results & treatment
<p>5 Measurement of coil resistance</p>	<p>[Refer to Technical Manual Basic Course II-1-c]</p> <ul style="list-style-type: none"> Remove the unit of electronic circuit, then measure the resistance of coil. The tester lead pins have no polarity. <p style="text-align: center;"><Tester range: Rx10Ω></p>	<ul style="list-style-type: none"> 2.2 kΩ ~ 2.6 kΩ → Normal Outside range of 2.2 kΩ ~ 2.6 kΩ → Replace coil unit.
<p>6 Check of train wheels</p>	<p>[Refer to Technical Manual Basic Course II-2-b]</p> <ul style="list-style-type: none"> Check clearance of each wheel. Check rotor for bust and oil. 	
<p>7 Check of dial-side mechanism</p>	<p>[Refer to Technical Manual Basic Course II-2-c]</p> <ul style="list-style-type: none"> Comfirm all parts are not deformed and are lubricated properly. 	
<p>8 Measurement and adjustment of time rate</p>	<p>[Refer to Technical Manual Basic Course II-2-d]</p> <p>Measurement range: Analog, 2 sec.</p> <div style="text-align: center;">  </div> <ul style="list-style-type: none"> Turn trimmer capacitor to right and left to adjust time rate. 	<ul style="list-style-type: none"> Can be adjusted. → Normal Cannot be adjusted or large error is made after adjustment. → Replace the electronic circuit unit.
<p>9 Confirmation of using condition</p>	<p>[Refer to Technical Manual Basic Course II-2-e]</p>	

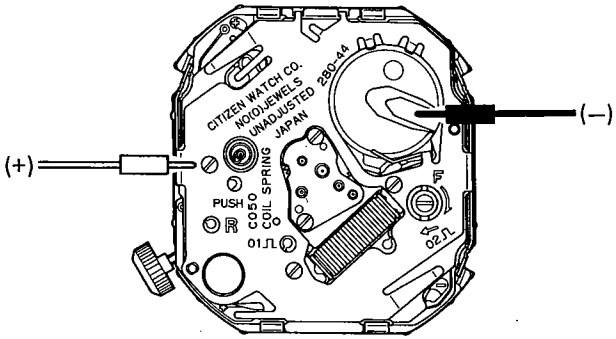
Check points	How to check	Results & treatment
<p>12 Measurement of current value</p>	<p>[Refer to Technical Manual Basic Course II-1-f]</p> <p>(1) Set the power cell to tester.</p> <p>(2) Set the lead pins of tester to the module. Before measurement of current, short-circuit the (R) part to the circuit unit supporter by tweezers.</p> <p style="text-align: center;"><Tester range: DC 12 μA></p>  <div style="border: 1px solid black; padding: 5px; margin-top: 10px;"> <p>Since current for alarm flows after all-reset operation, much current is consumed temporarily. Measure after it is stabilized.</p> </div>	<ul style="list-style-type: none"> ● Measured value of module complete is under 3.1 μA. → Normal ● Measured value of module complete is over 3.1 μA. → Inspect train wheel and dial side mechanism, and remove dust and stain, and oil. ● Pull the crown to reset power consumption switch. <p>Under 2.5 μA. → Normal</p> <p>Over 2.5 μA. → Electronic circuit unit is defective.</p> <p style="text-align: center;">⇩</p> <p style="text-align: center;">Replace the electronic circuit unit.</p>
<p>13 Check of appearance and functions</p>	<p>[Refer to Technical Manual Basic Course II-2-f]</p> <ul style="list-style-type: none"> ● Check inside of case for dust and stain. ● Confirm case back is tightened firmly (to 600 g·cm, for reference). ● Check operation of setting switches for normality. ● Check segment for normality (See 3 Check of LC display panel and connection part.) 	

CITIZEN WATCH CO., LTD.

Tokyo, Japan