

***TECHNICAL  
INFORMATION***

---

**CITIZEN QUARTZ**

**Cal. No. C04※**

## CONTENTS

	Page
§1. OUTLINE .....	1
§2. SPECIFICATIONS .....	2
§3. MECHANISM AND FUNCTIONS OF WATCH (To know altitude from the standard atmosphere [Barometric pressure]) .....	3
§4. NAME OF EACH PART .....	5
§5. CHANGE OF MODE .....	6
§6. HANDLING METHOD .....	7
§7. POINTS AND PRECAUTIONS FOR USE OF THIS WATCH .....	26
§8. PRECAUTIONS FOR REPAIR .....	30
§9. DISASSEMBLY AND ASSEMBLY OF MODULE .....	31
§10. TROUBLESHOOTING AND ADJUSTMENT .....	34

## S1. OUTLINE

This is the world's first combination quartz watch with a built-in electronic altimeter for outdoor sports.

### \* **Altimeter Measurement**

The altitude displayed on the watch is the relative altitude, as defined under International Civil Aviation Organization (ICAO) standard, of a local based on barometric pressure measurements taken by the watch's pressure sensor.

Therefore, even when a measurement is taken twice in the same place, if, there has been a change in the barometric pressure, the altimeter reading will also change.

### \* **Barometric Pressure Measurement**

The barometric pressure displayed on the watch is the barometric pressure of the present location, as measured by the sensor in the watch. The barometric pressure displayed, changes with any change in altitude. Use the watch's measurement function to observe barometric pressure change's, in a fixed locale.

## MAIN FEATURES

The CITIZEN QUARTZ ALTICHRON is the world's first electronic wristwatch with built-in electronic altimeter functions.

- Altitude measurement function valid between -300 and 5,000 meters from sea level. (-980 Ft. ~ 17,000 Ft.)
- Barometric pressure measurement function valid between 500 and 1,050 mbars.
- Indicators to display changes in barometric pressure (CAL. No. C040).
- Memory function capable of storing time and altitude records.
- Memory/measure function to record total amount of time spent in activity. For example, especially useful while mountain climbing, to display total climbing time from memory.
- Ability to withstand temperatures as low as -20°C (-4°F).

---

### Caution

---

The altimeter and barometer of this watch have not been authorized by any official institute. Accordingly, never use this watch under a dangerous condition. For example, the altimeter of this watch cannot be used to observe sudden change of altitude during sky diving etc., and the barometer cannot be used to forecast meteorological condition.

## 52. SPECIFICATIONS

Cal. No.		C040	C046
Type		Combination watch with altimeter (barometer)	
Module size (mm)		φ30.8 x 41.3, Thickness: 4.8 mm	
Accuracy		±20 sec/month at normal temperature	
Oscillation		32,768 Hz	
Indication method	Analog	3 hands	
	Digital	FE twist type nematic LC display by 3-section multiplex drive	
Integrated circuit		C/MOS-LSI: 2 units	
Effective temp. range		-20°C ~ 55°C (-4°F ~ 131°F)	
Accuracy of altimeter		Below 3,000 m: ±(5% ±10 m) Above 3,000 m: ±(8% ±10 m) *Relative accuracy measured in the standard atmosphere values	Below 9,840 feet: ±(5% ±20 feet) Above 9,840 feet: ±(8% ±20 feet)
(Additional functions of digital section)			
<ul style="list-style-type: none"> <li>● Time</li> <li>● Calendar</li> <li>● Alarm</li> <li>● Altitude measurement</li> <li>● Altitude recording function</li> <li>● Atmospheric pressure measurement</li> <li>● Barometric pressure change indication</li> <li>● Climbing time measurement</li> <li>● Climbing time recording function</li> </ul>		<p>Hour and minute (24-hour system)</p> <p>Month and day (No adjustment required at the end of month. 28-day system in February)</p> <p>Hour and minute</p> <p>Above sea level: -300 m ~ 5,000 m (Unit: 10 m)</p> <p>Time and altitude at 7 points max.</p> <p>500 mbar ~ 1,050 mbar (Unit: 1 mbar)</p> <p>Standard value indicated every hour by arrow:</p> <p>24-hour system: Minute and second (Less than 1 hour), Hour and minute (Longer than 1 hour)</p> <p>24-hour system: Minute and second (Less than 1 hour), Hour and minute (Longer than 1 hour)</p>	
		<p>-980 Ft. ~ 17,000 Ft. (Unit: 20 Ft.)</p> <p>Time and altitude at 4 points max.</p> <p>Barometric pressure change is not indicated.</p>	
(Other functions)			
<ul style="list-style-type: none"> <li>● Warning function of low battery voltage</li> <li>● Second hand stopping device</li> <li>● Power saving switch</li> </ul>		<p>Digital section: Colon [:] flashes.</p> <p>Stopped at any position by pulling crown by one click.</p> <p>Saved by pulling crown by one click.</p>	
Battery	No. Life Capacity	280 ~ 206 (Battery code: SONY CR2016) Approx. 2 years 72 mAH	
Current consumption		Within 2.2 μA	

This Technical Information describes Cal. No. C040 mainly.

**53. MECHANISM AND FUNCTIONS OF WATCH (To know altitude from the standard atmosphere [Barometric pressure] )**

The temperature, pressure, density, etc. of the atmosphere ranging from the ground to several hundreds kilometers are observed by using balloons, rockets, artificial satellite, etc. The collected data are summarized and a model of the atmosphere is made up from those data. This is called the "standard atmosphere".

The representative international standard atmosphere is ICAO (International Civil Aviation Organization) standard atmosphere used by ICAO.

This watch is so designed and developed that the altitude can be calculated from the barometric pressure by using the relationship between ICAO standard atmosphere and altitude.

The microcomputer in this watch calculates altitude from barometric pressure by linearizing the relationship between barometric pressure and altitude shown below.

In case of the standard atmosphere, temperature lowers as altitude is increased. However, this watch does not have a function of measuring the temperature and compensating the altitude with the temperature.

Altitude (m)	Temperature (°C)	Barometric pressure (mbar)	Altitude (m)	Temperature (°C)	Barometric pressure (mbar)
-400	17.6	1062.2	2600	- 1.9	737.5
-200	16.3	1037.5	2800	- 3.2	719.1
0	15.0	1013.25	3000	- 4.5	701.1
200	13.7	989.5	3200	- 5.8	683.4
400	12.4	966.1	3400	- 7.1	666.0
600	11.1	943.2	3600	- 8.4	649.2
800	9.8	920.8	3800	- 9.7	632.6
1000	8.5	898.7	4000	-11.0	616.4
1200	7.2	877.2	4200	-12.3	600.5
1400	5.9	856.0	4400	-13.6	584.9
1600	4.6	835.2	4600	-14.9	569.7
1800	3.3	814.9	4800	-16.2	554.8
2000	2.0	795.0	5000	-17.5	540.2
2200	0.7	775.4	5200	-18.8	525.9
2400	-0.6	756.3	5400	-20.1	511.9

[Outline of system of CAL. C04※]

● Configuration of basic system

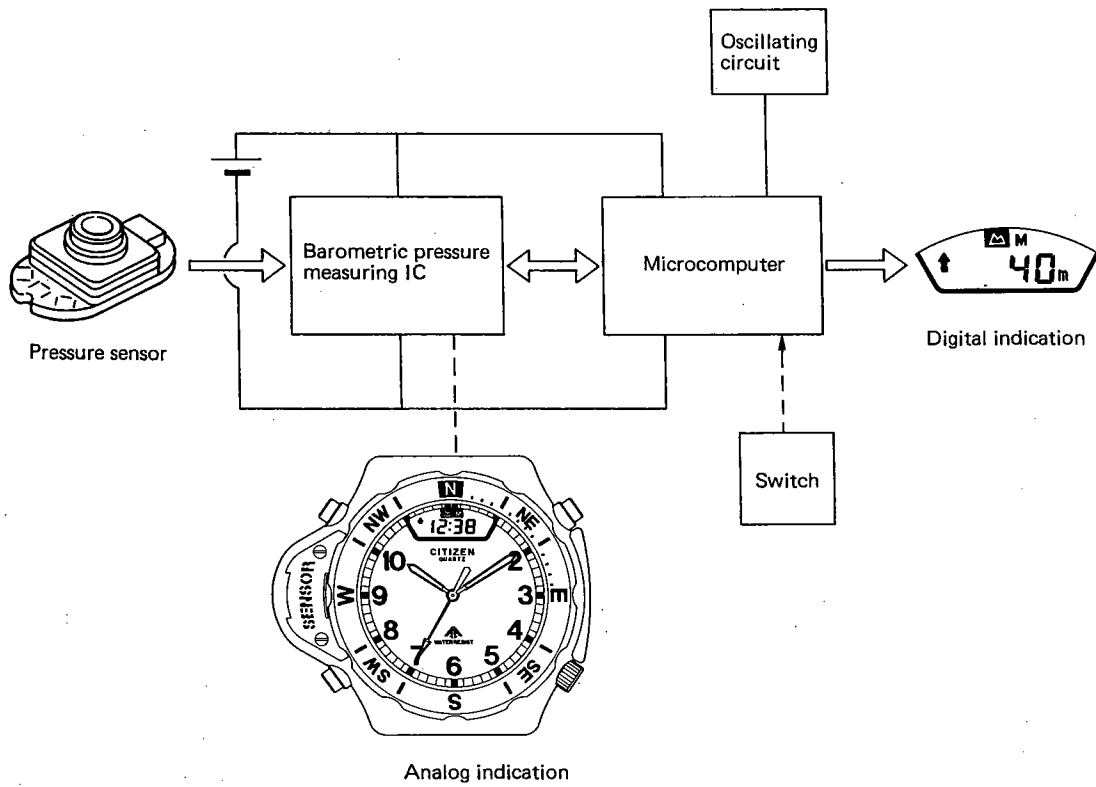

The microcomputer controls the digital indication and measurement of barometric pressure and calculates altitude.

The barometric pressure measuring IC is controlled by the microcomputer, and it drives the pressure sensor to measure barometric pressure. It also drives the hands through the hand operating circuit built in itself.

54. NAME OF EACH PART

**C040**  
(Indication in meters)

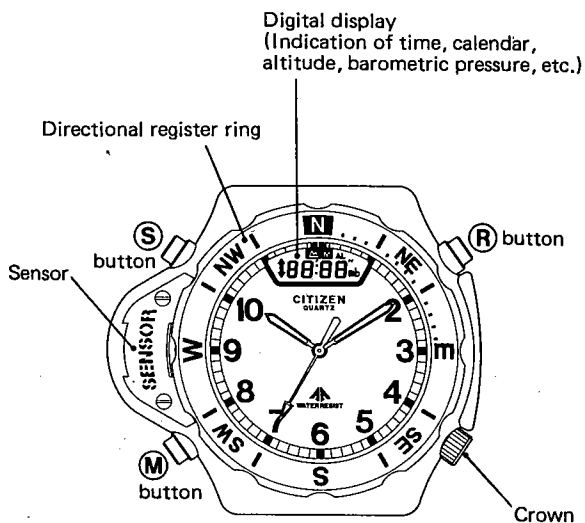

**C046**  
(Indication in feet)

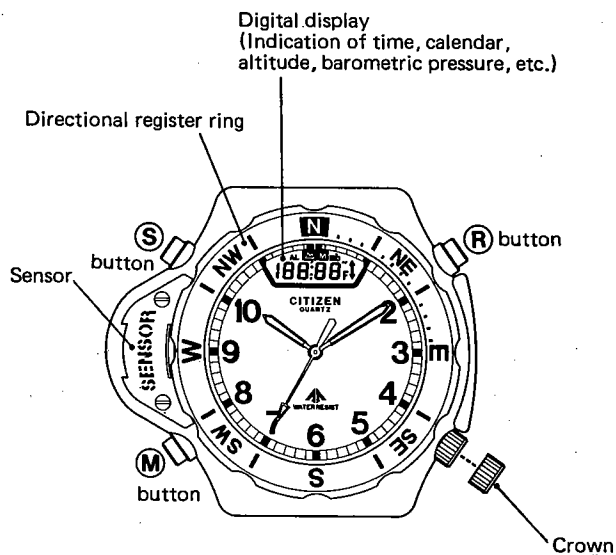

(Explanation of marks in the digital display)

**C040**

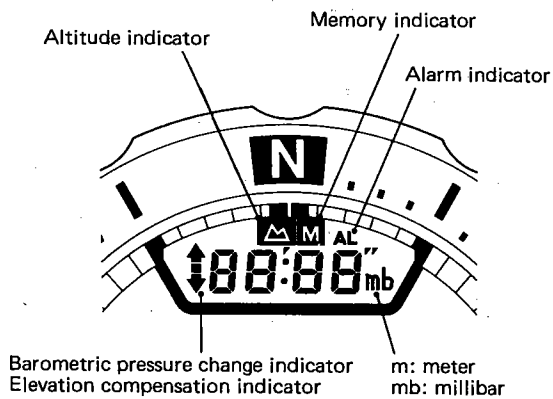

**C046**

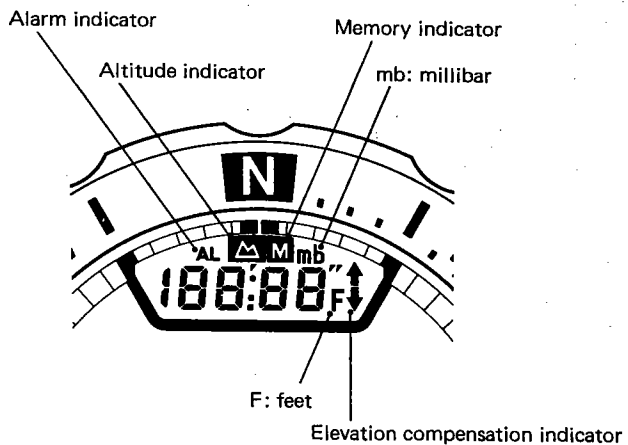

- P: checkpoint
- FL: memory full
- CL: calculation in progress
- : Altitude limitation  
(outside parameter of -300~5,000 meters (Cal. C040)/  
-980~17,000 feet (Cal. C046).)

## §5. CHANGE OF MODE

The basic mode consists of two modes; the Normal mode and Altimeter mode.

As shown below, the basic mode contains several small modes, and each of them can be selected by pressing the **(M)** button.

### 1) Change of basic mode

The basic mode consists of two modes; the Normal mode and Altimeter mode, and each of them can be selected by pressing and holding the **(M)** button (for about 2 seconds).

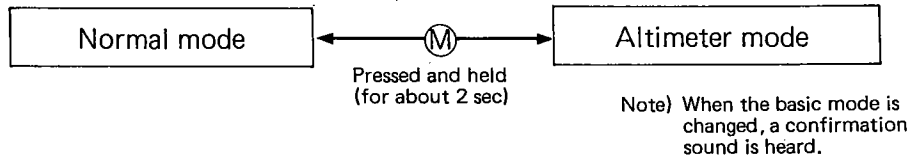

### 2) Change of small mode in basic mode

Each small mode in the basic mode can be selected by pressing the **(M)** button.

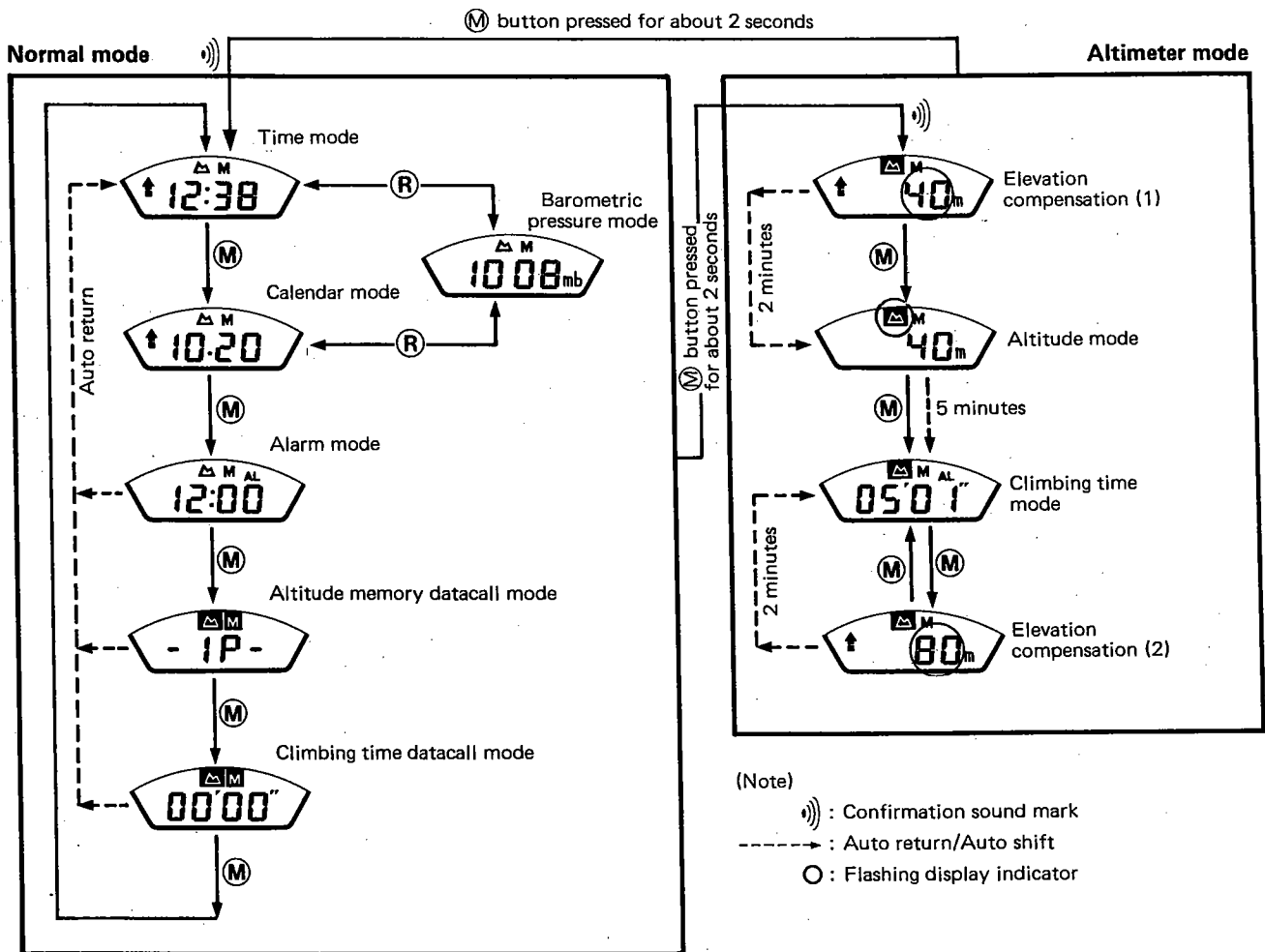



Basic mode	Small mode
Normal mode	<ul style="list-style-type: none"> <li>● Time mode, ● Calendar mode, ● Barometric pressure mode, ● Alarm mode,</li> <li>● Altitude memory data call mode, ● Climbing time data call mode</li> </ul>
Altimeter mode	<ul style="list-style-type: none"> <li>● Altitude Compensation mode 1/2, ● Altitude mode, ● Climbing time mode</li> </ul>

Note: While the time, calendar or alarm is being corrected, each mode cannot be changed to a small mode. In this case, press the (M) button once to change the correction mode to the normal indication mode, then change to a desired small mode.

[Auto return] This watch's display will automatically return to the normal Time mode if there is no button input for approximately two minutes while entered in any of the other modes: Alarm, Altitude memory of Climbing time datacall mode, and barometric pressure mode.

[Auto shift] There are two divisions under the Altimeter mode: Elevation compensation 1 and Elevation compensation 2. If there is no button input for approximately two minutes while entered in compensation mode 1, the watch will return to the Altitude mode: Compensation mode 2 will return to the Climbing time mode.

## 56. HANDLING METHOD

### 6-1. Analog display

#### (1) Setting the time

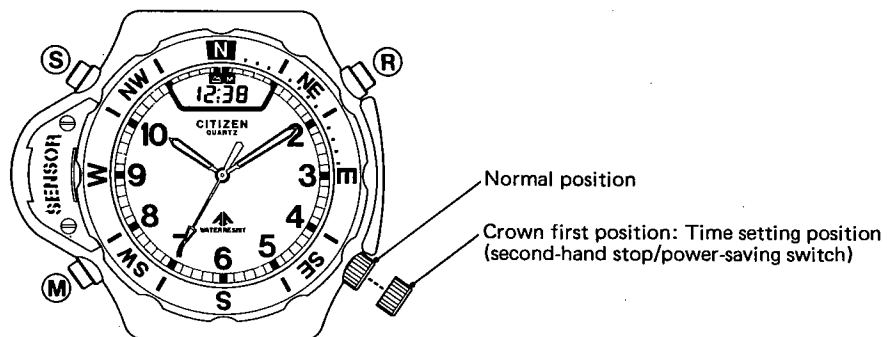

- Similar to a common analog watch, set the time by pulling the crown out to the first position and turning it.
- After the watch is set to the correct position, be sure to return the crown securely to the normal position. (The time setting of the analog display is independent from the digital display.)

## 6-2. Digital display

(Common items)

- Press and hold the (S) button for about 2 seconds in the normal mode to enter the setting mode, and the correctable part flashes. Correct that part with the (R) button.
- If the (R) button is pressed and held in the setting mode, the flashing digits advance fast.
- If an effective input is not given for about 2 minutes in the setting mode of each mode, the watch is automatically set to the normal display (Auto-return).
- If the (M) button is pressed in the setting mode of each mode, the watch is forcedly set to the normal mode (Manual return).

### I. Normal mode

#### (1) Time setting

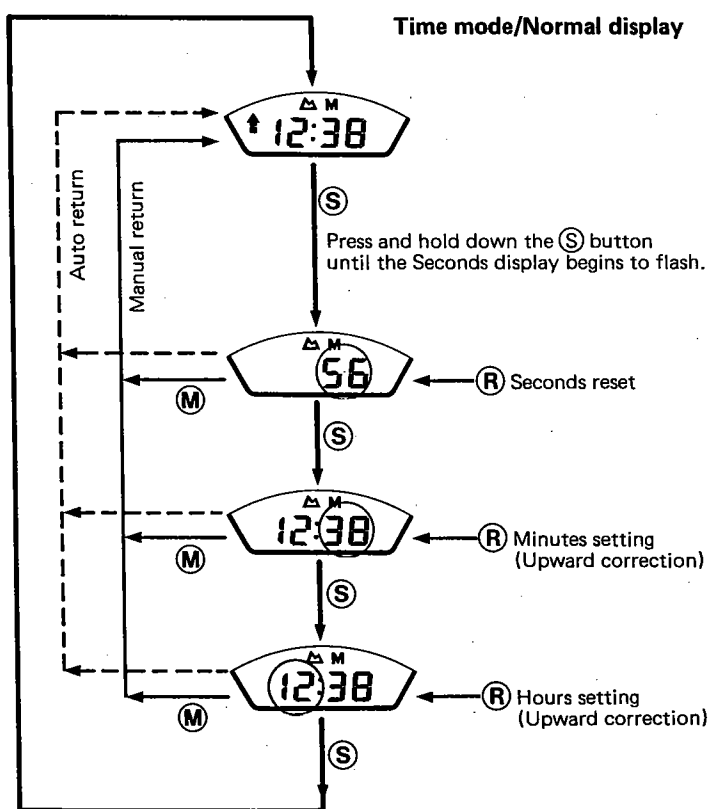

- Zero reset: If the (R) button is pressed while the seconds display is flashing, the latter is reset to zero. When the (R) button is pressed, if the seconds display is between 30 and 59, the minute display is automatically advanced by one minute.
- If the (M) button is pressed in the normal display state, the watch is set to the barometric pressure mode (See the section of the barometric pressure mode: page 12).

## (2) Calendar settings

### Calendar mode/Normal display

Press the (M) button once in the time mode to enter the Calendar mode.

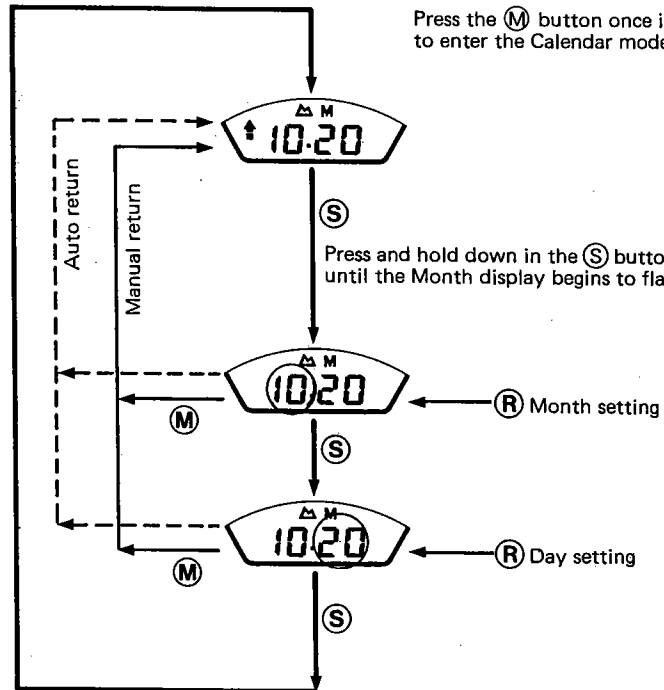

- If a nonexistent date is set, the watch will automatically adjust and display the date for the first day of the next consecutive month upon return to the normal Calendar display. (Example: 30/Feb. → 01/March)
- Manual setting is not required for the date at the end of the month. The only date adjustment necessary is during a leap year where 29/Feb. must be set manually.

### (3) Alarm settings

#### Alarm mode/Normal display

Press the (M) button twice in the Time mode to enter the Alarm mode.

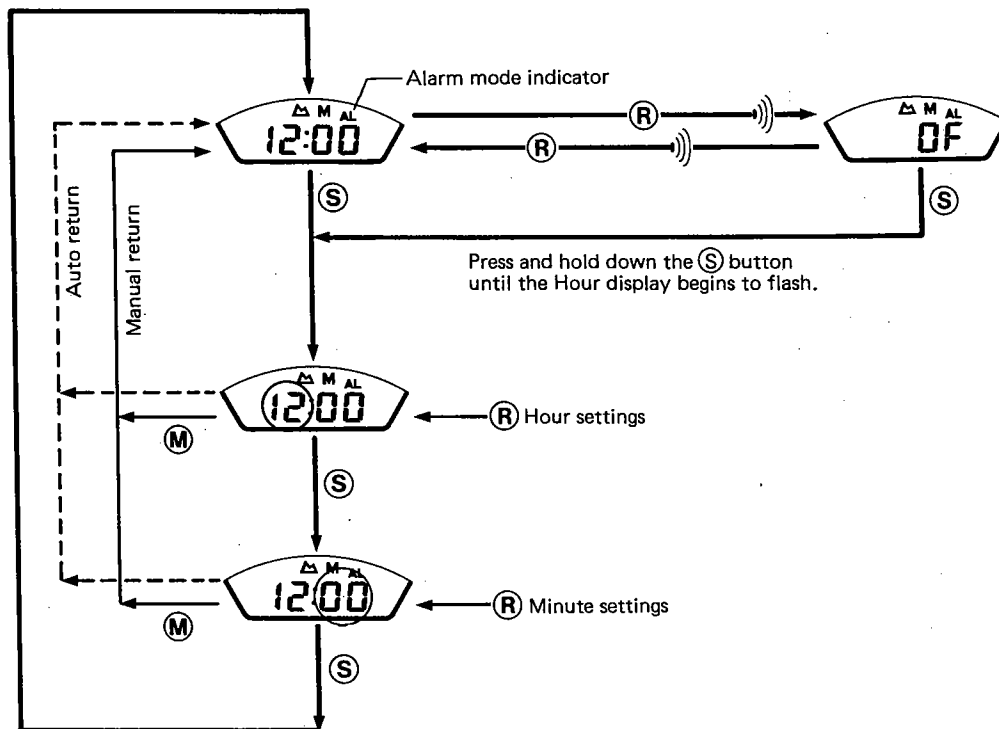

- Press the (R) button in the normal Alarm mode to set the ON/OFF switch. The confirmation beep will sound in this mode.
- The alarm is automatically switched ON when alarm settings are complete.
- The alarm will sound for 20 seconds at the designated time. Press any button to turn the Alarm off.

#### (4) Altitude memory datacall

- This watch has the memory capacity to store and call up seven different checkpoint entries according to number, time and altitude in the Altitude mode and Climbing time mode. (CAL. C046 has 4 points memories)

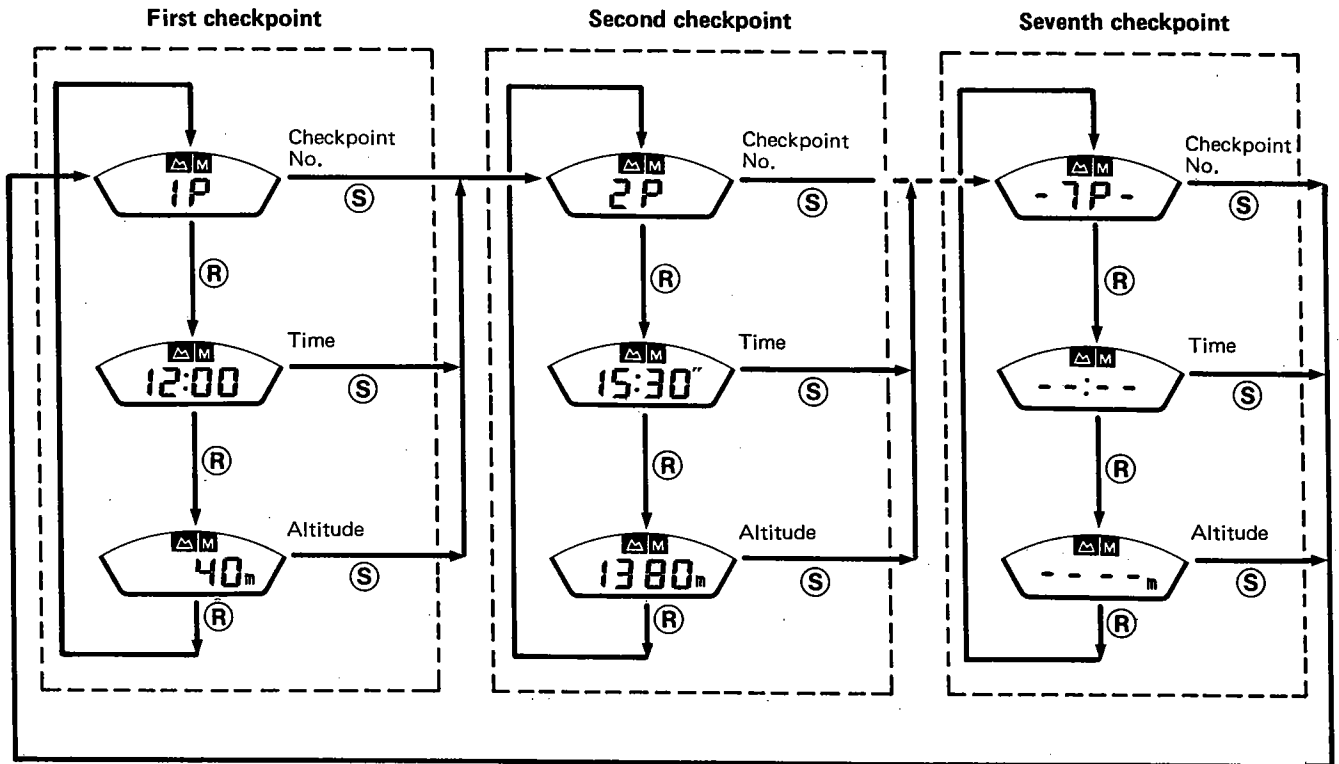

- Press the (M) button three times in the Time mode to enter the Altitudes memory data-call mode and display the first checkpoint entry.
- Press the (R) button to display the time and altitude recorded in memory.
- The checkpoint numbers are displayed in order from 1P to 7P each time the (S) button is pressed. (1P, 2P, 3P ... 7P, 1P ... ) Time and altitude is displayed by pressing the (R) button.
- Time values for entries in memory are designated with colons (:). Altitude values are designated in meters (m).
- If any data is in the memory, the display becomes as shown in the first and second checkpoint display in the above figure. If no data are in the memory, bars are displayed before and after the point No. (e.g. -7P-) as shown in the seventh checkpoint display. In this case, the time and altitude displays also indicate bars.
- Cancellation of altitude entries in memory: Press the (R) and (S) buttons simultaneously while altitude memory data call mode, and all the data in the memory are canceled and the display returns to [-1P-]. At this time, the confirmation sound is heard. This operation is effective when the data of eight points or more are necessary. However, any necessary data must be recorded by another means before they are canceled.

### (5) Climbing time datacall

In this mode, the climbing time entered in the altimeter mode can be called back. The start/stop operation is possible. See (9).)

- Press the (M) button four times in the Time mode to enter the Climbing times datacall mode.
- Climbing time values are represented by the 24-hour system. Times less than 60 minutes are displayed as minutes, seconds [':"]; times exceeding 60 minutes are displayed in hours, minutes, [':"]; following 23:59, the display repeats from 0'00.

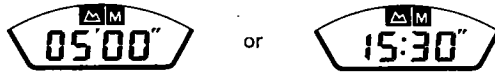

- Climbing times stored in memory will be deleted when the Altimeter mode is entered from the Normal mode.

### (6) Barometric pressure mode

- Press the (R) button in the Time or Calendar mode to enter the Barometric pressure mode.

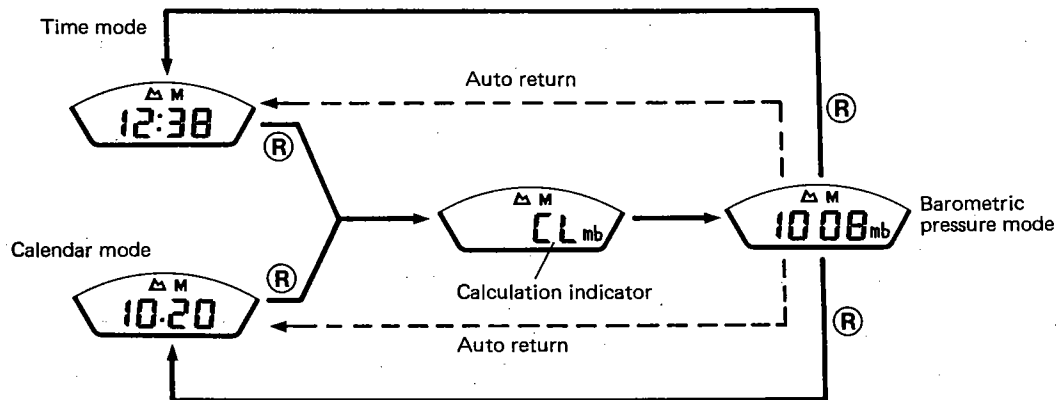

- Before the watch is set to the barometric pressure mode, the mark of [CLmb] indicating the barometric pressure is being measured is displayed for a moment.
- If the (R) button is pressed while the barometric pressure is displayed, the display returns to the original mode. In addition, the barometric pressure mode is automatically returned to the original mode after two minutes.

## Barometric pressure change display

- This watch is designed to measure the barometric pressure every hour on the hour. The latest pressure reading is then compared and displayed on the watch by an arrow pointing up (▲) if the value is higher than the previous hours measurement or by an arrow pointing down (▼) if the value is lower. (only for CAL. No. C040)

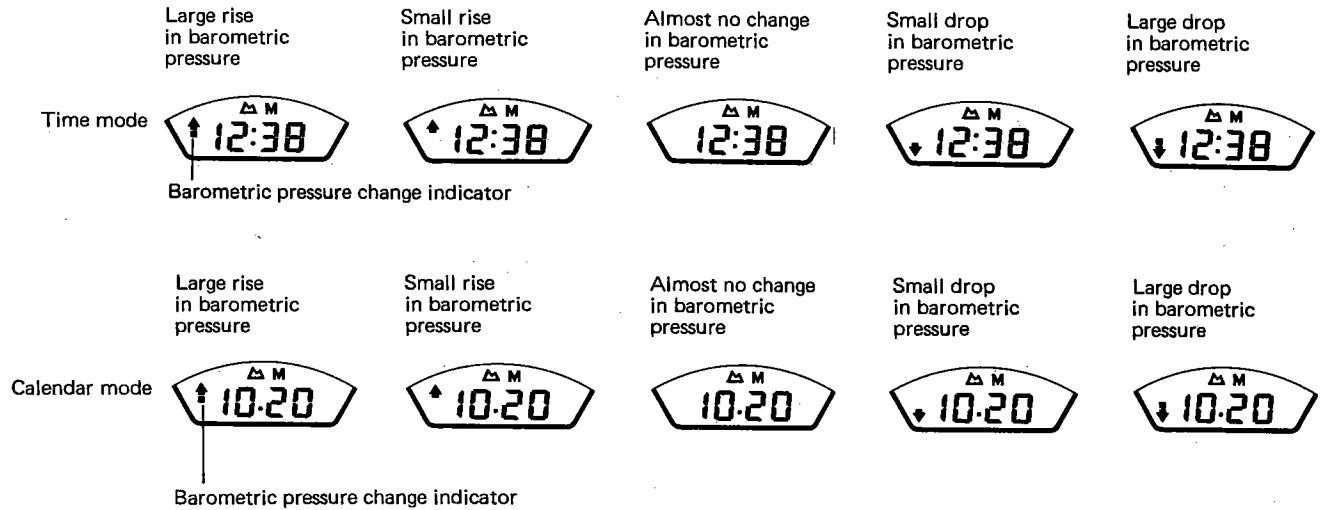

- The pressure change indicator is displayed in the normal mode.
- This indicator is displayed for reference only.  
If the barometric pressure changes more than 1 mbar, [▲, ▼] are displayed, and if the former changes by about 0.6 mbar, [▲, ▼] is displayed. If the change of the barometric pressure is less than those value, any pressure indicator is not displayed. These pressure indicators may be displayed differently from the actual change of the barometric pressure because of disturbance at the measurement made every hour on the hour or another reason. When necessary, confirm the current value in the barometric pressure mode.
- Deleting barometric pressure arrows: Switching to the Altimeter mode or RESET operation will cancel all barometric pressure arrows displayed. New pressure values will be recorded at the next hour.

## II. Altimeter mode

### (7) Elevation compensation mode (1)

Press and hold down the (M) button for approximately two seconds in any of the watch's normal display modes to call up Elevation compensation mode (1) in the Altimeter mode.

\* **The altitude values displayed on this watch are relative based on figures designating the value of a standard atmosphere.** In order to ensure accurate measurements with this watch, it is necessary to set the watch to an altitude reference previously determined as correct such as a standard sea-level mark or map-designated elevation.

This procedure is referred to as elevation compensation.

A change in the atmosphere pressure of 1 mbar is equivalent to approximately 10 meters in elevation, therefore while mountain climbing, because of the radical changes in weather and changes in pressure, it may be necessary to revise your watch settings during the day.

### Elevation compensation

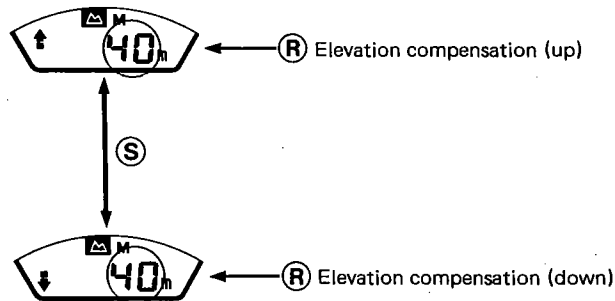

- When you enter the Elevation compensation mode, the CLm mark is first displayed and then the altitude display begins to flash.
- Press the (R) button and set the altitude value to the reference you chose as a compensation point. When the arrow indicator is pointing up, adjust upward. When the arrow is pointing down, adjust downward by pressing the (S) button.
- Press and hold down the (R) button to "forward fast" the adjustment digits.
- Altitude values can be adjusted between -300 and 5,000 meters in 10 m increments. (CAL. No. C046: -980 and 17,000 feet in 20 feet increments.)
- Altitude measurements are based on the results of the latest elevation compensations and will remain the basis for measurements until the next compensations are input.
- Auto shift: If an effective input is not given through a button for about 2 minutes in the first compensation mode, the watch is automatically set to the altitude mode.



- Compensation clear: Pressing the (R) and (S) buttons simultaneously will delete any elevation compensation. The altitude displayed after a compensation clear is based on the atmospheric pressure at the time and because it is only a relative value it will differ slightly with the actual altitude.

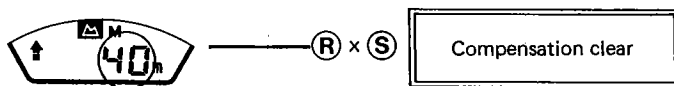

### (8) Altitude mode

This mode allows you to observe the changes in altitude over a period of time – in this case, five minutes. Press the (M) button once in elevation compensation mode (1) to enter the Altitude mode. In this mode the mark [  $\Delta$  ] flashes.

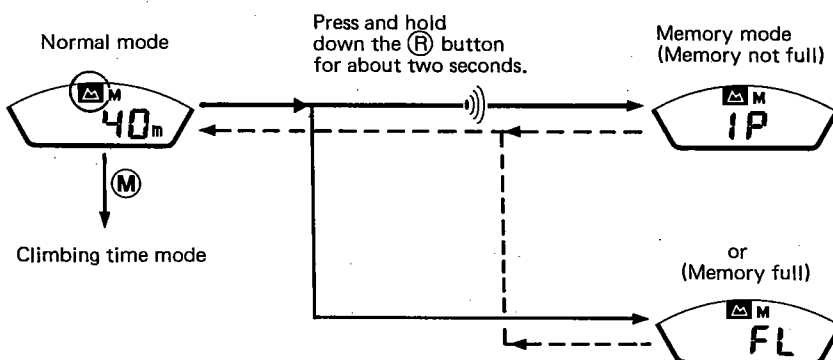

- The measurement period is 1–1.5 seconds.
- This mode is effective in such cases the altitude constantly changes as mountain climbing, riding a cable car, ballooning, etc.
- This mode is kept for five minutes.
- After five minutes, the watch is automatically set to the climbing time mode. If the (M) button is pressed, the watch is also set to the climbing time mode.
- Measurements are limited within -300 and 5,000 meters. Exceeding these limits will cause the watch to display as follows (—) and all measurements are lost.

### Altitude memory operations

- If the (R) button is pressed and held in the altitude mode, a point [1P, 2P, —→ 7P] is displayed, and the current time and altitude are stored. When the point is displayed, the confirmation sound is heard to notify that the time and altitude have been stored.
- The time and altitudes at up to seven points (places) can be stored.
- If the (R) button is pressed after the time and altitudes at seven points have been stored, the mark of [FL] is displayed to notify that any more data cannot be stored.
- When space is needed for more than seven entries, copy the entry data in the watch's memory to a separate place, enter the Altitude memory datacall mode and press the (R) and (S) buttons simultaneously to delete all the entries in memory.
- The total number of entries, from the Altitude mode and Climbing time mode combined, in memory is limited to seven.

### (9) Climbing time mode

Press the **(M)** button twice in the elevation compensation mode (1) to enter the climbing time mode.

If the **(R)** button is pressed in this mode, the watch indicates the climbing time, altitude and barometric pressure. If the **(R)** button is pressed and held (for about 2 seconds), the time and altitude at each point can be stored, similarly to the altitude mode.

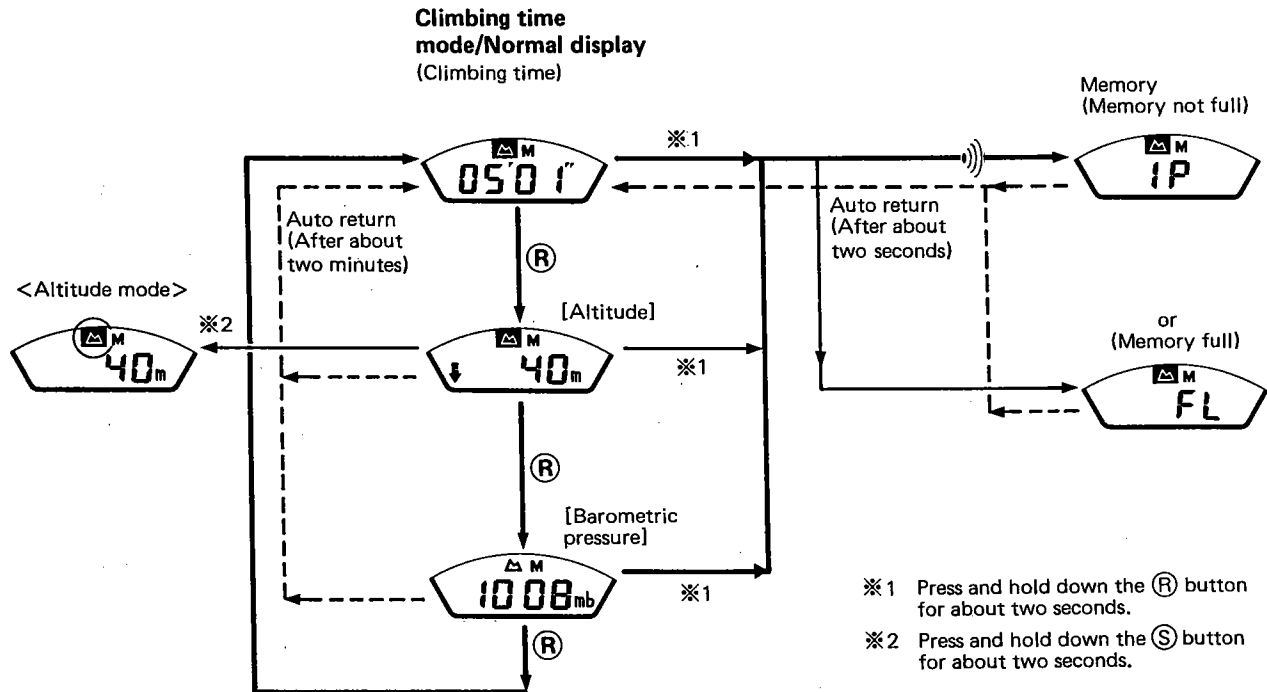

- Auto return  
About 2 seconds after data is stored and about 2 minutes after altitude and barometric pressure are indicated.

- If the **(S)** button is pressed and held (for about 2 seconds) while the altitude is indicated in this mode, the watch is returned to the altitude mode.
- The measurement of the climbing time is started when the **(M)** button is pressed in the altitude compensation mode (1) to enter the altitude mode. However, if the **(S)** button is pressed while the climbing time is indicated, measurement is stopped, and if the former is kept pressed, the measurement is reset to zero.  
If the **(S)** button is pressed again, measurement is started again.

## Stopwatch operation (Climbing time mode)

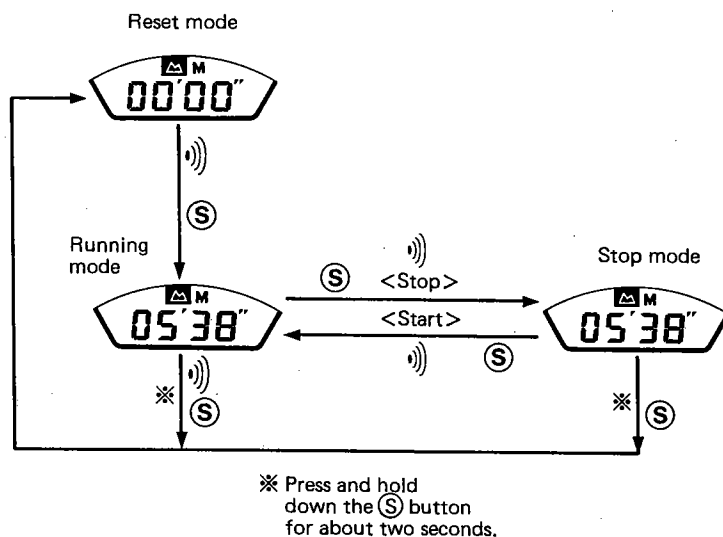

If the **(M)** button is pressed held while the watch is reset to enter the normal mode and the climbing time datacall is selected, the climbing time is set to [00'00'']. If this operation is performed while the climbing time measurement is stopped, the stop time is indicated.

- Climbing times can be recorded up to 23 hours 59 minutes. Times less than 60 minutes are displayed as minutes, seconds; times exceeding 60 minutes are displayed as hours, minutes.

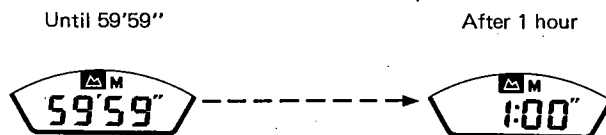

- If the **(R)** button is pressed in either mode of climbing time, altitude and barometric pressure, the point No., current time and current altitude can be stored in the memory. When the point No. is indicated, the confirmation sound is heard and the climbing time is indicated, too.
- Data at up to seven points can be stored together with the data in the altitude mode. (CAL. No. C046: 4 points only)

## (10) Elevation compensation mode (2)

If the **(M)** button is pressed three times in the altitude compensation mode (1), the watch is set to the altitude compensation mode (2). First, **[CL]** is indicated, then altitude is displayed. Use this mode similar to the Elevation compensation mode (1).

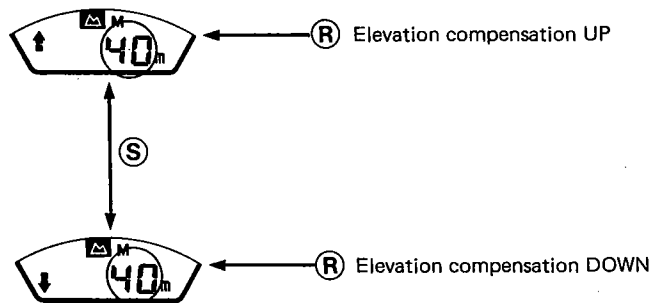

- The altitude newly set in the altitude compensation mode (1) or altitude compensation mode (2) is used as the standard altitude.
- The compensation unit, compensation range and compensating method of the Elevation compensation mode (2) are the same as the Elevation compensation mode (1). See (7).

## ICAO Altimeter Features

List of altitude, barometric pressure and temperature under the standard atmospheric pressure.

One of the representative international standard atmosphere is the ICAO Standard Atmosphere employed by the International Civil Aviation Organization (ICAO). Cal. C04\* is so developed that the altitude can be calculated by utilizing the relationship between the barometric pressure specified by ICAO atmosphere and the altitude.

The following table shows the relationship between the barometric pressure specified by ICAO atmosphere and the altitude.

\*Standard atmosphere

Altitude (gpm)	Temperature (°C)	Barometric pressure (mbar)	Altitude (gpm)	Temperature (°C)	Barometric pressure (mbar)
-300	16.95	1049.8	2600	- 1.9	737.5
-200	16.3	1037.5	2800	- 3.2	719.1
0	15.0	1013.25	3000	- 4.5	701.1
200	13.7	989.5	3200	- 5.8	683.4
400	12.4	966.1	3400	- 7.1	666
600	11.1	943.2	3600	- 8.4	649.2
800	9.8	920.8	3800	- 9.7	632.6
1000	8.5	898.7	4000	-11.0	616.4
1200	7.2	877.2	4200	-12.3	600.5
1400	5.9	856.0	4400	-13.6	584.9
1600	4.6	835.2	4600	-14.9	569.7
1800	3.3	814.9	4800	-16.2	554.8
2000	2.0	795.0	5000	-17.5	540.2
2200	0.7	775.4			
2400	-0.6	756.3			

Barometric pressure and temperature on sea level: 1013.25 mbar, 15.0°C, 0 m.  
 Change ratio of temperature up to 11 km above sea level:  $-6.5^{\circ}\text{C}/\text{km}$

- \* Generally, the indication by an altimeter is different from the true altitude because of the difference of the ambient condition such as the barometric pressure, temperature, etc. Accordingly, the indication of the altimeter needs to be compensated. This operation by C04\* is call the elevation compensation.
- \* The indication of the the altimeter changes even in the same place if the barometric pressure changes, so the compensation is required.
- \* The barometric pressure appearing in newspapers, etc. is converted into the value at 0 m above the sea, and it is accordingly different from the barometric pressure in the true means.

● **Altitudes of cities in the world.**

\*Use as the standard altitudes.

Country	City	Altitude (m)	Country	City	Altitude (m)
(Asia)			(North America)		
India	New Delhi	208.8	Canada	Ottawa	82.8
Singapore	Singapore	8.2	U.S.A.	Washington	0.2
Japan	Tokyo	28.0	(Central and South America)		
(Europe)			Argentina	Buenos Aires	9.4
France	Paris	65.9	Ecuador	Quito	2815.1
Finland	Helsinki	20.6	Mexico	Mexico City	2268.5
Italy	Rome	45.0	Panama	Panama	9.0
Iceland	Reykjavik	8.0			
Norway	Oslo	30.6			
Portugal	Lisbon	75.1			
Spain	Madrid	655.4			

● **Major high mountains in the world**

\*Mountains below 5000 m

Region	Mountain name	Altitude (m)	Region	Mountain name	Altitude (m)
(Asia)			(Africa)		
Iran	Zard kuh	4548	Ethiopia	Ras Dashan	4620
Malaysia	Kinabalu	4094	Morocco	Toubkal	4165
Indonesia	Rinjani	3726	Algeria	Tahat	2918
Burma	Victoria	3053	(North America)		
Japan	Fuji	3776	U.S.A.	Whitney	4418
(Europe)			U.S.A.	Elbert	4398
France,	Mont Blanc	4807	Canada	Keel Peak	2972
Italy			(Other regions)		
Switzerland	Matterhorn	4477	Panama	Baru	3475
Spain	Aneto	3404	Papua New	Wilholm	4509
Greece	Olimbos	2917	Guinea		
Rumania	Moldoveanu	2543	Hawaii Islands	Manua Kea	4205
Norway	Gilitterind	2470	New Zealand	Cook	3764
			Australia	Kosciusko	2230

# PRACTICAL INFORMATION

## Features and Outline of C040

### Features

Combination watch equipped with an altitude sensor first in the world.

- Altitude measurement range: -300 m ~ 5,000 m
- Barometric measurement range: 500 mbar ~ 1,050 mbar
- With barometric pressure change indication
- With altitude (time/altitude) memory
- With climbing time measurement function
- Resistance to low temperature down to -20°C (-4°F)

### Barometer characteristics

This watch obtains the altitude from the change of barometric pressure by utilizing the relationship between the barometric pressure and altitude under the condition of the standard atmosphere specified by ICAO (International Civil Aviation Organization) (1013.25 mbar at 15°C (59°F) on the sea level is set to 1 atm, and the temperature lowers by 6.5°C (43.7°F) as the altitude is increased by 1,000 m).

### Normal mode

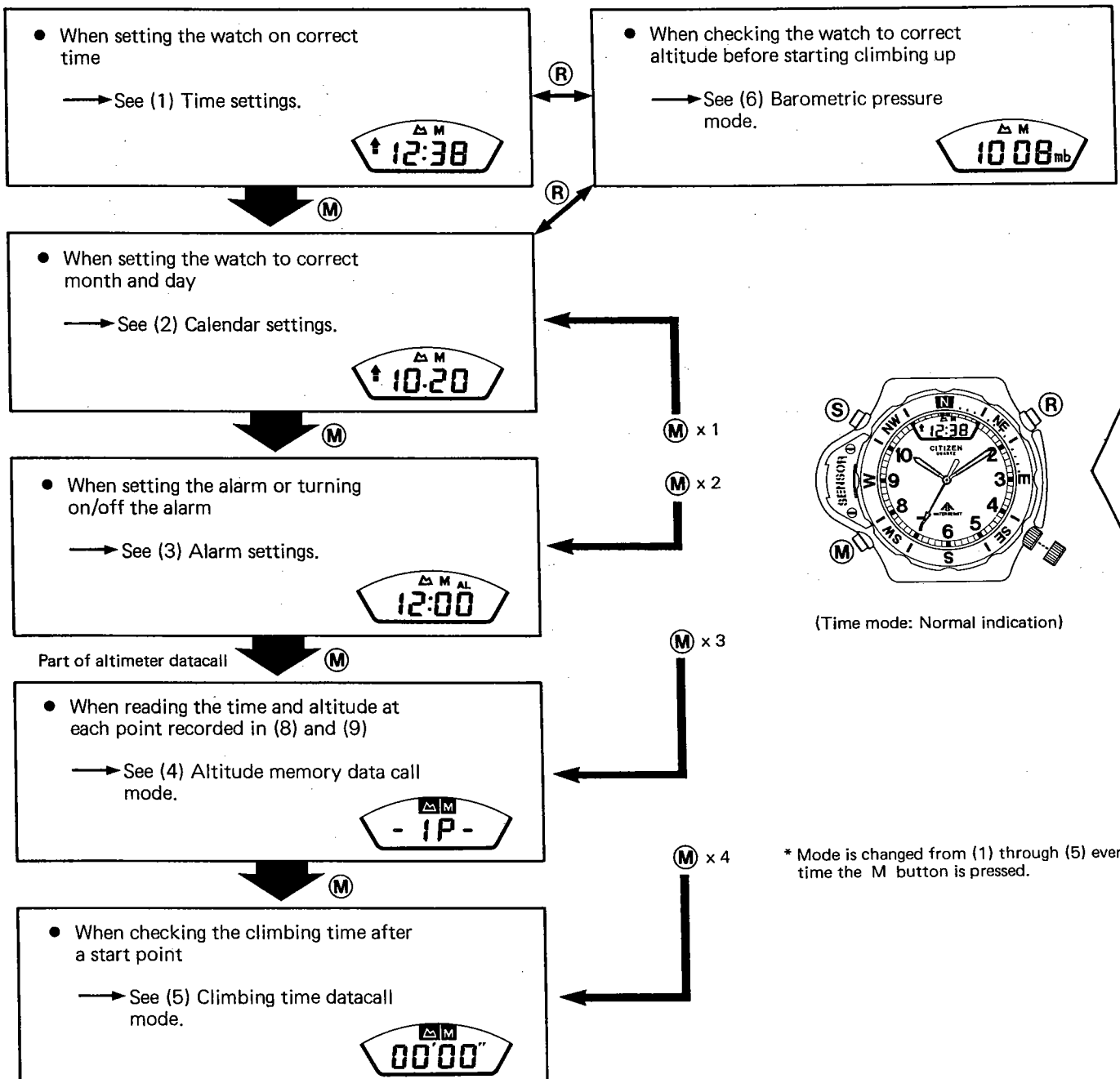

Accordingly, the indication by the altimeter changes as the barometric pressure, temperature, etc. change, even if the altitude is measured at the same place. For this reason, the indication needs to be corrected at the standard altitude (point). This operation is called the "altitude compensation". Be sure to perform this operation when measuring the altitude with this watch.

### Types of modes

- |                              |                                      |
|------------------------------|--------------------------------------|
| (Normal mode)                | (Altimeter mode)                     |
| (1) Time settings            | (7) Elevation compensation mode (1)  |
| (2) Calendar settings        | (8) Altitude mode                    |
| (3) Alarm settings           | (9) Climbing time mode               |
| (4) Altitude memory datacall | (10) Elevation compensation mode (2) |
| (5) Climbing time datacall   |                                      |
| (6) Barometric pressure mode |                                      |

\* The numerals in parenthesis refer to those in "6. Handling method". For details, see section 6.

### Altimeter mode

Press the **M** button for about 2 seconds.

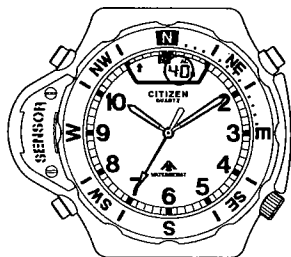

(Altimeter compensation mode (1))

- When setting the watch to correct altitude before starting climbing up  
→ See (7) Altitude compensation mode (1).



- When following up changing altitude
- When storing the time and altitude at some points  
→ See (8) Altitude mode.



- When measuring the time from a start point to a destination by using this watch as a stopwatch
- When recording the time and altitude at some points during climbing  
→ See (9) Climbing time mode.



- When compensating the altitude again at a standard point during climbing  
→ See (10) Altitude compensation mode (2).



\* When returning from mode (9) or (10) to (7) or (8), the watch must be set temporarily to the normal mode.

## How to use this watch C04※ (an example)

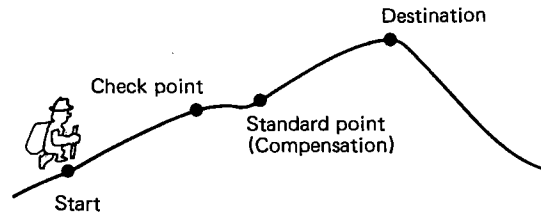

### 1) Transfer from normal mode to altitude mode



- First, press and hold the (M) button (for about 2 seconds) to change the mode from the normal mode to the altitude compensation mode (1) in the altimeter mode.
- Press the (S) button and confirm the direction of the arrows, then press the (R) button to compensate the altitude. (When compensating the lowering altitude, press the (S) button once to direct the barometric pressure change indicator downward, then compensated with the (R) button.



### 2) Starting operation



- Next, press the (M) button twice to set the watch to the climbing time mode. Then, press and hold the (S) button (for about 2 seconds) to reset the indication to zero, and the watch is prepared for starting measurement.
- Press the (S) button again, and the measurement of the climbing time starts. (The watch operates as a stopwatch.)



### 3) Check of altitude and barometric pressure during climbing

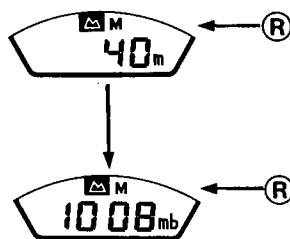

- Press the (R) button once, and the altitude is indicated. Press it again, and the barometric pressure is indicated. Press the (R) button again, and the watch indicates the climbing time again. In this way, the climbing time, altitude and barometric pressure can be checked easily.







#### 4) Recording of time and altitude at a check point

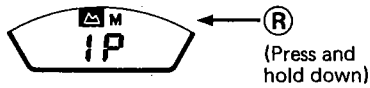

- If the (R) button is pressed and held (for about 2 seconds) in the climbing time mode, "1P" showing the first check point is indicated and the confirmation sound is heard to tell the data is stored.
- Similarly, the data at up to seven check points can be stored.

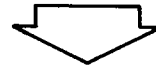

#### 5) Reaching the destination and stopping the climbing time



- After you reach the destination, press the (S) button to stop the measurement of climbing time.

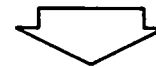

#### 6) Calling the time and altitude at each check point

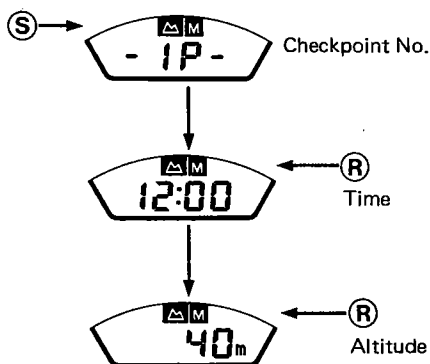

- Press and hold the (M) button (for about 2 seconds) to return from the altimeter mode to the normal mode.
- Next, press the (M) button three times to enter the altitude memory datacall mode.
- The check point is changed from 1P to 7P every time the (S) button is pressed, and the time and altitude at each point are displayed every time the (R) button is pressed. At this time, take the record of necessary data in a notebook.



#### 7) Deletion of data



- After the necessary data is written in the notebook, press the (S) and (R) buttons at the same time. By this operation, all the data are deleted.
- If the data are deleted, the display of "1P" is changed to "-1P-" to show the data are deleted.
- If this operation is not performed, any data after 7P is not accepted.

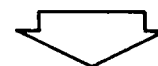

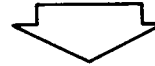

### 8) Calling the required climbing time



Less than 1 hour:  
Indication of minute and second

- Press the  button, and the climbing time recorded when the watch is stopped in 5) is indicated. If necessary, take the record of this time, too, in the notebook. (When the watch is changed from the altitude compensation mode (1) to another mode, the watch is set to the start mode, and the old climbing time is deleted. This climbing time can be also reset to zero by resetting operation in 2).



### 9) Returning to the normal time mode



- Press the  button once to return to the normal time mode.

The above is the operation for measuring the altitude and climbing time.

### **Other examples of use**

It is important for consumer to get accustomed with the operation of this watch before use (Please refer outline and S7 Points and Precautions for use of this watch.)

### **Checking the changing altitude constantly**

If the watch is set to the altitude mode, the altitude is indicated every five minutes while you are riding a climbing car, ski lift, cable car, etc.

### **Checking the altitude difference between start point and point at which you are now**

Compensate the altitude to zero at the start point in the altitude compensation mode (1) or (2), and you can see the altitude difference easily. The measurable range is from -300 m to 5,000 m. The unit of the compensation and indication of altitude is 10 m.

### **Weather forecasting**

In the barometric pressure mode, it is possible to see if the barometric pressure is rising or dropping, and the weather can be forecast more or less. That is, if the barometric pressure is rising, normally the weather will be fine, and if the former is dropping, the weather will be cloudy or rainy. In the time mode, calendar mode and altitude compensation mode, the current barometric pressure is automatically compensated with the value one hour before every hour on the hour, and its tendency is indicated by arrows. The rise/drop of about 0.6 mbar are indicated by [  $\blacklozenge$ ,  $\blacklozenge$  ], and those larger than 1 mbar are indicated by [  $\blackuparrow$ ,  $\blackdownarrow$  ]. If the barometric pressure has changed little, no arrows are indicated.

However, the current barometric pressure is indicated every time the watch is set to the barometric pressure mode.

### **Use in a tunnel**

This watch normally works in a place below the sea level. It measures the negative altitude down to -300 m.

### **For sky sports**

This watch is also useful for ballooning, etc. However, it is important to compensate the altitude before using for any sky sport.

Since the sensor of this watch measures the altitude every 1.5 seconds, it cannot be used to check very quick change of the altitude during sky diving, etc.

## 57. POINTS AND PRECAUTIONS FOR USE OF THIS WATCH

(Direct the users of CAL. No. C04\* to read the instruction manual carefully and obtain the correct knowledge before using the watch.)

The measuring functions of this watch are not certified by any public institute. Do not use this watch to judge condition when the result of that judgment may cause a danger.

Before using this watch, read the instruction manual and understand its functions, then use its indication for only reference.

### 1. Inhibition of use

Do not use the functions of this watch under the following conditions for the reasons of its functions and performance.

- The result of judgment may cause a danger.
- Barometric pressure fluctuates largely because of the change of weather.
- Atmospheric temperature changes largely.
- Pressure is controlled in an airplane, a building, etc.
- Altitude changes largely in a short time.
- Special uses other than the normal use (explained in the instruction manual).

### 2. Altitude measuring function

The altitude indicated by this watch is a relative altitude obtained by applying the relationship between the altitude and barometric pressure of the international standard atmosphere to the barometric pressure measured by the pressure sensor. Accordingly, the indicated altitude changes if the barometric pressure changes, even if it is measured at the same place.

This watch measures and indicates altitude at the interval of about 1.5 seconds (in the continuous altitude measurement mode), thus it cannot be used for sports in which the altitude changes largely in a short time (Sky diving etc).

The continuous altitude measurement mode is automatically changed to the action time measurement mode after five minutes. To return it to the watch into the continuous altitude measuring mode, take the procedure explained in the instruction manual.

For the effective use of the altitude measuring function of this watch, it is necessary to compensate the altitude at each place where it is indicated.

### 3. Barometric pressure measuring function

This watch indicates barometric pressure measured by the pressure sensor at each measuring point. Accordingly, the indicated barometric pressure changes as altitude changes, and it is different from the barometric pressure shown in a weather map (which is converted into the value at 0 m above sea).

This watch measure barometric pressure only one time when ordered. Measure several times to obtain accurate barometric pressure.

Use the barometric pressure measuring function of this watch to see the change of barometric pressure at a fixed point.

### 4. Compass function

This watch can be used as a compass by utilizing the position of the sun. Use the indicated directions for only reference.

---

---

**5. Sensor**

The sensor used for this watch is a precision device. Never disassemble it or poke it. Take care that dust will not enter it.

**6. Power cell**

The life of the power cell used in this watch is about two years when used under the normal condition. However, it depends on how the functions are used. Thus, the power cell should be replaced a little earlier than the estimated life end.

## General use precautions

### Barometric pressure sensor

Barometric pressure  
sensor cover

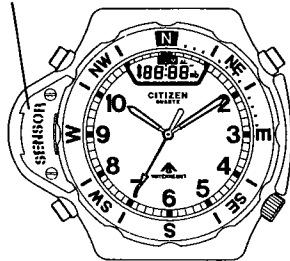

- The sensor cover protects the barometric pressure sensor inside. Do not remove.
- The sensor in this watch is dependent on the free passage of air over its internal parts.
- There is possible for the sensor to freeze or fail to function properly should water get under the protective sensor cover. If the watch does get wet, be sure to allow it to dry out completely before attempting to use it again.

### Directional Register Ring < Northern Hemisphere >

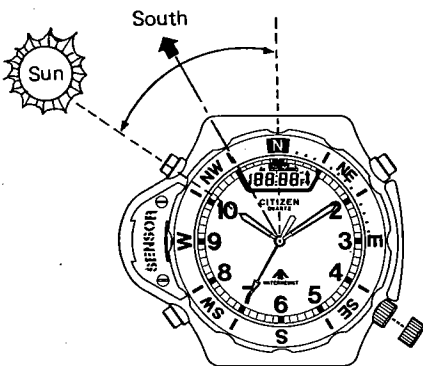

- One of the features of this watch is a directional register ring for use in the Northern Hemisphere. By aligning the hour hand with the position of the sun in the sky, the middle point between the hour hand and the 12 o'clock position will indicate south. Align the S mark on the register ring with the south, and all points of the compass (directions) can be roughly determined. (The directional register should be used for only reference, since its accuracy depends on the latitude and seasonal conditions.)

### Water-resistant leather band

- Some models of this watch are sold with thick, water-resistant leather band which are stronger than most normal leather watchbands. However, note that they are not so designed that they will stand a long-time use under water.

If they are stained with sweat, dirt, etc. wipe with dry cloth. In addition, it should be also noted that the water-resistance of these bands is weakened as the they are used.

### Water-resistant properties

- This watch and its atmospheric pressure sensor are not designed for use under high-pressure or excessively wet conditions.
- The water-resistant specifications of this watch cover normal, everyday work and play conditions. Do not use this watch while skin diving or other basic water sports.

### Temperature specifications

- This watch is designed to withstand low temperatures common at altitudes of up to 5,000 meters in winter.

( $-20^{\circ}\text{C} \sim 55^{\circ}\text{C}$ / $-4^{\circ}\text{F} \sim 131^{\circ}\text{F}$ )

This watch operates normally in this temperature range. However, at around  $-20^{\circ}\text{C}$ , the liquid crystal display does not response normally and it may not follow up the fast operation of seconds indication etc.

### Barometric pressure display

- This watch's atmospheric pressure measurements are based on the standard atmospheric pressure, and the quantity of change is indicated. However, since the atmospheric pressure indicated by this watch is always relative to the standard atmospheric pressure at 0 m above sea, 1013.25 mbar and  $15^{\circ}\text{C}$ , use it as a reference value.

### Use on an airplane

- The barometric pressure in a passenger airplane is kept to the value about 20% lower than the standard atmosphere on the ground while it is cruising stably. Accordingly, the correct altitude cannot be indicated. However, if the watch is set to the barometric pressure mode, the barometric pressure in the airplane is indicated.

(The barometer cannot correctly measure air pressure in an elevator, air dome stadium, etc, where the air pressure is controlled.)

### Low battery voltage warning

- If the battery voltage lowers below a certain level, the colon [:] flashes to notify the low voltage. Under this condition, accurate measurement is impossible.
- In the Barometric pressure mode: Colon in the time mode flashes after Clmb is indicated.
- In the Altitude compensation modes (1) and (2) and altitude mode: Colon in the climbing time mode flashes after Clmb is indicated.
- \* The watch may be set to this condition when the ambient temperature is very low (around  $-20^{\circ}\text{C}$  ( $-4^{\circ}\text{F}$ )) or the battery voltage is lowering.

### All-reset operation (to be taken after battery is replaced)

- If the **(R)**, **(S)** and **(M)** buttons are pressed at the same time, all liquid crystal elements are turned on. If the buttons are released, the confirmation sound is heard, and the all reset operation is finished. By this operation, all the modes are initialized as follows.

Time	: 00:00
Calendar	: Jan. 1st
Alarm	: OFF
Altitude datacall	: -1P-
Climbing time datacall	: 00'00''

- \* After the battery is replaced, be sure to perform this operation. If it is not performed, the indication may not be displayed or become abnormal.

## 58. PRECAUTIONS FOR REPAIR

### ● Installation of sensor

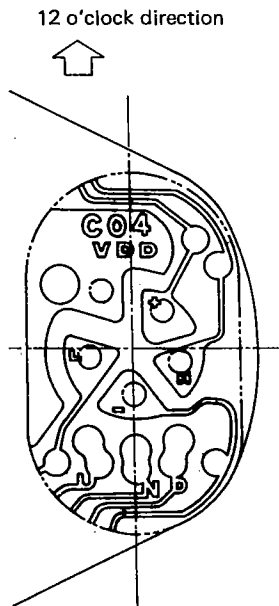

- 1) The sensor has directional properties. Install it in the case with the stamp of CO4\* in the direction of 12 o'clock point. If it is installed inversely, barometric pressure and altitude are indicated abnormally, or a bar (——) is indicated instead of them.
- 2) The sensor and the circuit are adjusted as one unit, thus **be sure to replace them as a unit**. If only either of them is replaced, the barometric pressure etc. cannot be measured accurately.
- 3) After the sensor is installed, confirm it is not bent.

### ● Barometric pressure and altitude indicated when the case is fitted

The sensor of this watch has five coil springs. When the case is fitted, an unstable force is temporarily applied to the sensor, and a value a little higher than the true value may be indicated. This does not mean a trouble. 30 ~ 60 minutes after the case back is tightened, the springs are stabilized and accurate values will be indicated.

### ● Sensor contact springs

Five sensor contact springs are used in this watch. If they are bent or fatigued, they are not in perfect contact with the sensor, and true values may not be indicated.

If the contacts are stained or dirt sticks to them, sufficient electrical continuity cannot be made, and true values cannot be obtained. In this case, remove the stain and dirt.

### ● Handling of sensor

Section of sensor

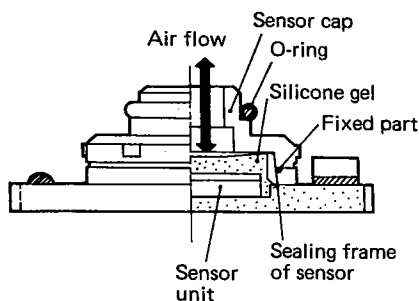

The sensor is protected by gel material as shown in the figure at left. Never stick it with a bar.

The sensor is covered with the sensor cap (secured with two screws). If the air passage is clogged with dust, the measurement will be inaccurate. In this case, remove the sensor cap and remove the dust so that air will flow through the passage.

The sensor is made of plastic. Since it is filled with silicone gel (black soft material), do not wash it. If dust has entered it and caused malfunction of the sensor, replace the sensor and the circuit as one set.

### ● Seal for distinguishing the module

When the watch is shipped out of the factory, its accuracy is highly controlled, and the data seal is stuck to its module. Do not remove that seal.



## 59. DISASSEMBLY AND ASSEMBLY OF MODULE

Disassembly procedure : ① → ③⑨  
 Assembly procedure : ③⑨ → ①

### Lubrication symbols

- Ⓐ▷ A lube
- ∇▷ V lube
- Ⓕ▷ F lube
- ∞▷ CH-1

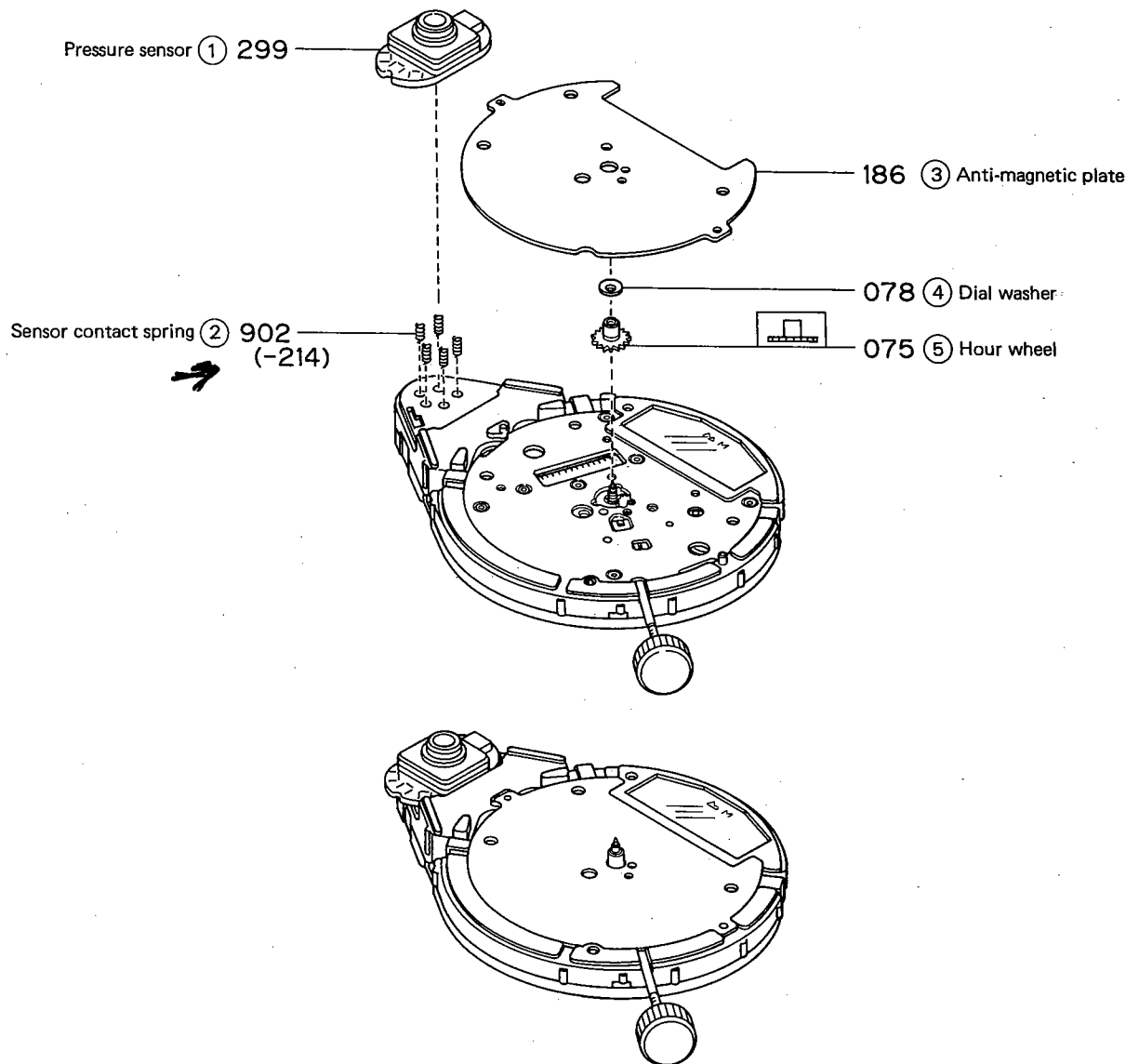

- Note:
- Pressure sensor and unit of electronic circuit are supplied as a set. Be sure to replace both of them at the same time.
  - Anti-magnetic plate has directional properties. If it is inverted, dial cannot be mounted.

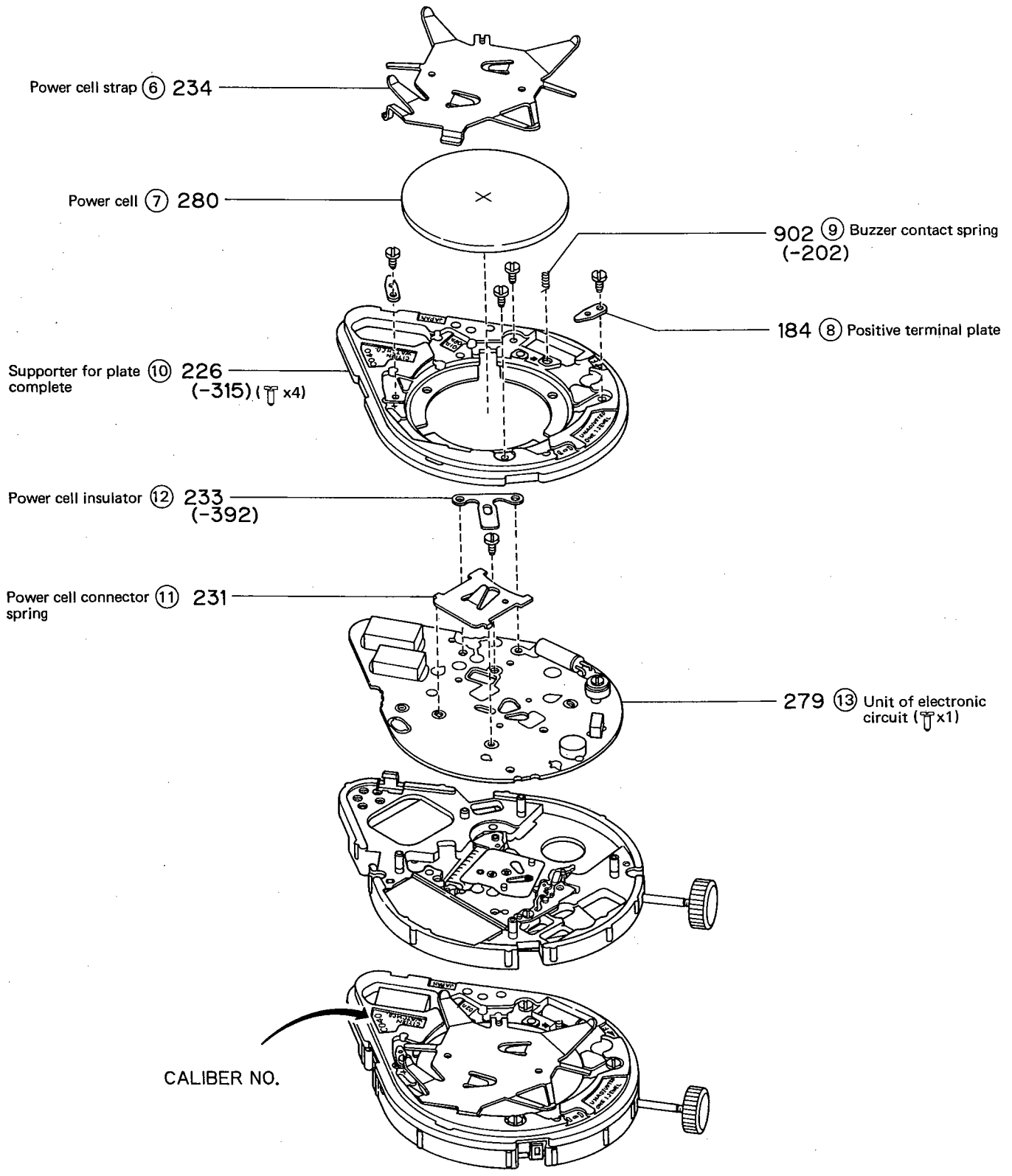

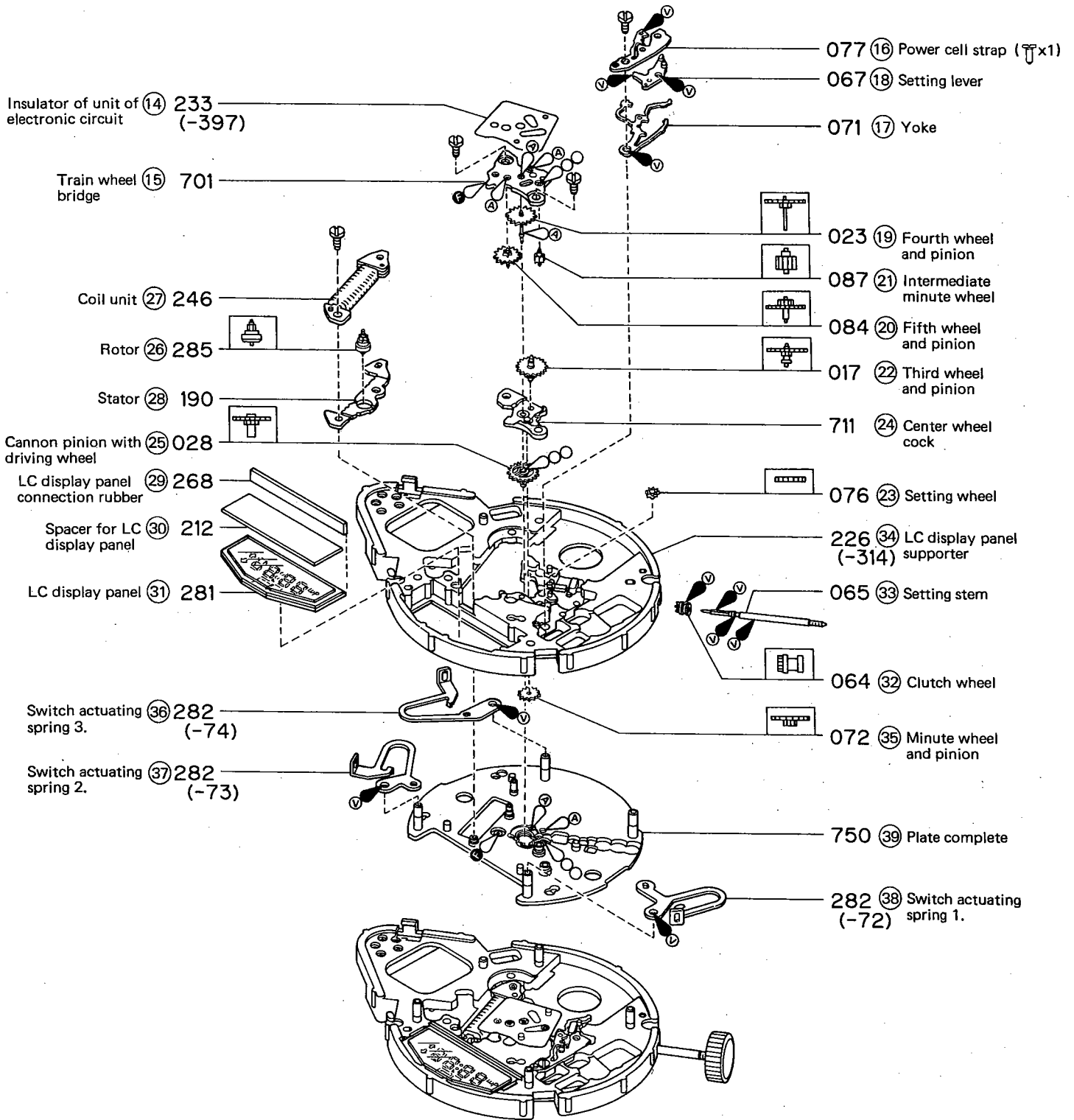

# \$10. TROUBLESHOOTING AND ADJUSTMENT

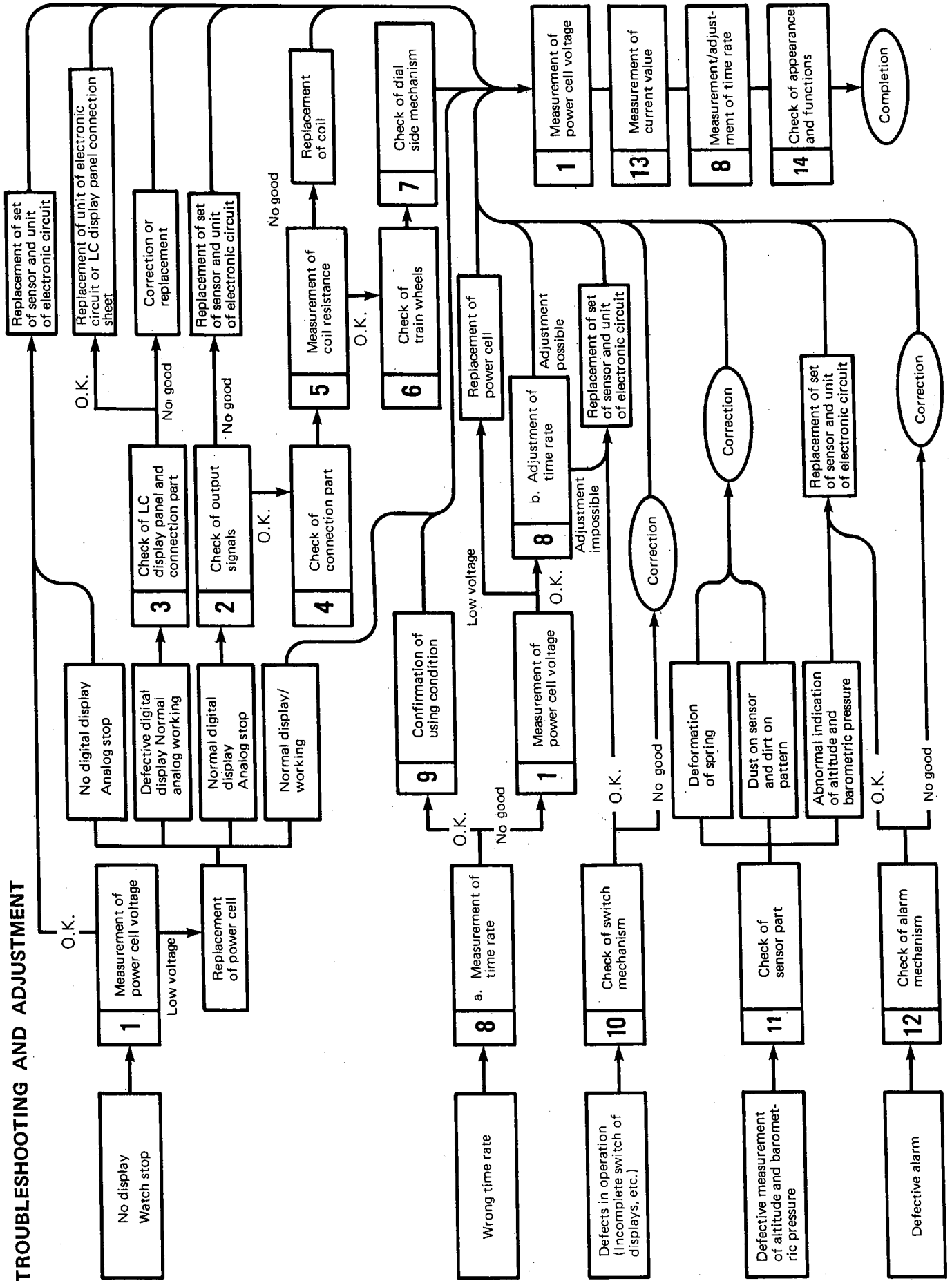

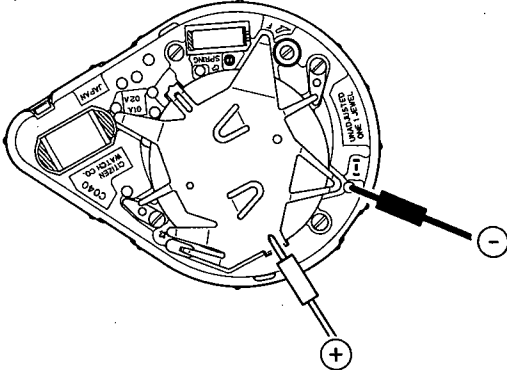
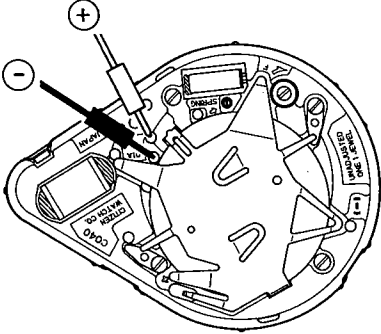
Check points	How to check	Results & treatment
<p>1 Measurement of power cell voltage</p>	<p>[Refer to Technical Manual Basic Course II-1-a]</p> <p>&lt;Tester range: DC 12V&gt;</p> 	<ul style="list-style-type: none"> <li>● <b>Over 2.8V</b> → Normal</li> <li>● <b>Under 2.8V</b> → Replace the power cell.</li> </ul>
<p>2 Check of output signals</p>	<p>[Refer to Technical Manual Basic Course II-1-b]</p>  <p>&lt;Tester range: DC 0.3V&gt;</p> <p>(The tester lead pins have no polarity.)</p>	<ul style="list-style-type: none"> <li>● The tester pointer swings every 1 second. → Normal</li> <li>● The tester pointer does not swing. → Check the connections parts</li> </ul> <p style="text-align: center;">⇩</p> <ul style="list-style-type: none"> <li>● The connections are normal. → Replace the electronic circuit unit and sensor as a set.</li> </ul>
<p>3 Check of LC display panel and connection part</p>	<p>[Refer to the Digital Section of Technical Manual Basic Course II-2-a]</p> <ul style="list-style-type: none"> <li>● Inspection of all segments (Press the <b>M</b>, <b>S</b> and <b>R</b> buttons at the same time to turn on all the segments, and check for defective ones.</li> <li>● Continuity test on LC display panel, cell connection rubber and plate complete Check the parts for stain, breakage, etc.</li> </ul>	<ul style="list-style-type: none"> <li>● LC display panel, connection rubber or plate complete is not installed correctly. → Install correctly</li> <li>● Parts are stained or dirty. → Remove stain and dirt.</li> <li>● Parts are cut, broken or scratched. → Replace parts.</li> </ul>
<p>4 Check of connection part</p>	<p>[Refer to Analog Section of Technical Manual Basic Course II-2-a]</p>	

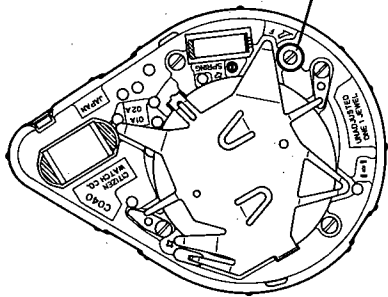
Check points	How to check	Results & treatment
<b>5</b> Measurement of coil resistance	<p>[Refer to Technical Manual Basic Course II-1-c]</p> <ul style="list-style-type: none"> <li>● Remove the unit of electronic circuit, then measure the resistance of coil.</li> <li>● The tester lead pins have no polarity.</li> </ul> <p style="text-align: center;">&lt;Tester range: Rx10Ω&gt;</p>	<ul style="list-style-type: none"> <li>● 2.6 kΩ ~ 3.2 kΩ → Normal</li> <li>● Outside range of 2.6 kΩ ~ 3.2 kΩ → Replace coil unit.</li> </ul>
<b>6</b> Check of train wheels	<p>[Refer to Technical Manual Basic Course II-2-b]</p> <ul style="list-style-type: none"> <li>● Check clearance of each wheel. Check rotor for dust and oil.</li> </ul>	
<b>7</b> Check of dial-side mechanism	<p>[Refer to Technical Manual Basic Course II-2-c]</p> <ul style="list-style-type: none"> <li>● Confirm all parts are not deformed and are lubricated properly.</li> </ul>	
<b>8</b> Measurement and adjustment of time rate	<p>[Refer to Technical Manual Basic Course II-2-d]</p> <p style="text-align: center;">&lt;Measurement range: Analog, 2 sec.&gt;</p> <div style="text-align: center;">  </div> <ul style="list-style-type: none"> <li>● Turn trimmer capacitor to right and left to adjust time rate.</li> </ul>	<ul style="list-style-type: none"> <li>● Can be adjusted. → Normal</li> <li>● Cannot be adjusted or large error is made after adjustment. → Replace the electronic circuit unit and sensor as a set.</li> </ul>
<b>9</b> Confirmation of using condition	<p>[Refer to Technical Manual Basic Course II-2-e]</p>	

Check points	How to check	Results & treatment
<p>⑩ Check of switch mechanism</p>	<p>1. Inspection of movement.</p> <ul style="list-style-type: none"> <li>● Press the switch return spring with tweezers, etc. to contact it to plate complete, and confirm the switching function.</li> <li>● Check for removal of pattern of electronic circuit unit, deformation of switch return spring, etc.</li> </ul> <p>2. Inspection of push button</p> <ul style="list-style-type: none"> <li>● Check push button for deformation, stain, etc.</li> </ul> <div style="border: 1px solid black; padding: 5px; margin-top: 10px;"> <p>(Note) Be sure to apply silicone oil to the packing of push button for waterproofness and smooth operation. Apply it to the packing of the sensor, too.</p> </div>	<ul style="list-style-type: none"> <li>● Switching function is normal. → Inspect push button.</li> <li>● Pattern is removed or deformed. → Replace defective parts.</li> <li>● Push button is stained or deformed. → Remove stain, or replace push button.</li> </ul>
<p>⑪ Check of sensor</p>	<p>Referring to the repair method and precautions explained in §8, perform the following inspection.</p> <ol style="list-style-type: none"> <li>1. Check the sensor contact spring for deformation.</li> <li>2. Check the contact parts of sensor and circuit for stain, dust, etc.</li> </ol> <p style="margin-left: 20px;">&lt; Abnormal indication &gt; If the digital indicator indicates abnormally, be sure to perform the all-reset operation, as when the power cell is replaced.</p> <ol style="list-style-type: none"> <li>3. Only bar (——) is indicated.</li> <li>4. Altitude and barometric indication is abnormal.</li> <li>5. Altitude cannot be corrected.</li> <li>6. Memory function does not work.</li> </ol>	<ul style="list-style-type: none"> <li>● Spring is deformed. → Replace contact spring.</li> <li>● Sensor or circuit is stained or dirt. → Remove stain and dirt.</li> </ul> <div style="border: 1px solid black; padding: 5px; margin-top: 10px;"> <p>Confirm watch has been handled normally. → See §3 and §6.</p> </div> <ul style="list-style-type: none"> <li>● Sensor is installed upside down. → Set correctly.</li> <li>● Indication is still abnormal after all-reset operation. → Replace the electronic circuit unit and sensor as a set.</li> </ul>

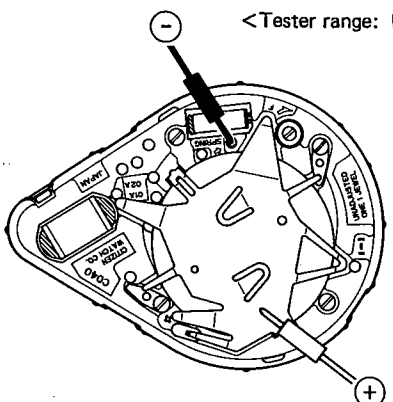
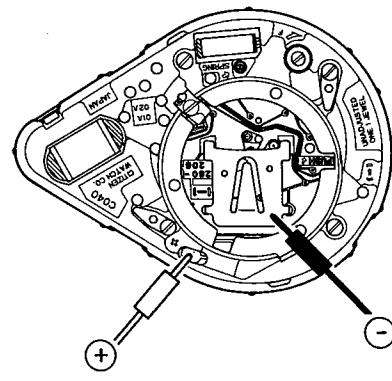
Check points	How to check	Results & treatment
<p>12 Check of alarm mechanism</p>	<p>[Refer to Technical Manual Basic Course II-1-d]</p> <p>*1. Set the module in the case, and check output of alarm with the case back removed.</p> <p>(1) Set the watch in alarm mode.</p> <p>(2) Apply ⊕ lead pin to power cell surface and ⊖ lead pin to buzzer contact spring, then press Ⓜ button.</p>  <p>*2. If the output of alarm is normal, perform the following inspection.</p> <ul style="list-style-type: none"> <li>• Check the piezo-electric element of vibrating plate for cracks and breakage.</li> <li>• Check the buzzer contact spring for bend and deformation.</li> <li>• Check the pattern of electronic circuit unit for dust and stain.</li> </ul>	<ul style="list-style-type: none"> <li>• Tester pointer swings every time Ⓜ button is pressed. → Normal</li> </ul> <p style="text-align: center;">⇩</p> <ul style="list-style-type: none"> <li>• Perform inspection in *2.</li> </ul> <p style="text-align: center;">⇩</p> <ul style="list-style-type: none"> <li>• Tester pointer does not swing. → Replace the electronic circuit unit and sensor as a set.</li> </ul>
<p>13 Measurement of current value</p>	<p>[Refer to Technical Manual Basic Course II-1-f]</p> <p>(1) Set the power cell to tester.</p> <p>(2) Set the lead pins of tester to the module, and perform the all-reset operation.</p> <p style="text-align: center;">&lt;Tester range: DC 12 μA&gt;</p>  <div style="border: 1px solid black; padding: 5px; margin-top: 10px;"> <p>Since current for alarm flows after all-reset operation, much current is consumed temporarily. Measure after it is stabilized.</p> </div>	<ul style="list-style-type: none"> <li>• Measured value of module complete is <b>under 2.2 μA.</b> → Normal</li> <li>• Measured value of module complete is <b>over 2.2 μA.</b> → Inspect train wheel and dial side mechanism, and remove dust and stain, and oil.</li> <li>• Pull the crown to reset power consumption switch.</li> </ul> <p><b>Under 1.7 μA.</b> → Normal</p> <p><b>Over 1.7 μA.</b> → Electronic circuit unit is defective.</p> <p style="text-align: center;">⇩</p> <p style="text-align: center;">Replace the electronic circuit unit and sensor as a set.</p>



Check points	How to check	Results & treatment
⑭ Check of appearance and functions	<p>[Refer to Technical Manual Basic Course II-2-f]</p> <ul style="list-style-type: none"><li>● Check inside of case for dust and stain.</li><li>● Confirm case back is tightened firmly (to 600 g·cm, for reference).</li><li>● Check operation of setting switches for normality.</li><li>● Check segment for normality (See ③ Check of LC display panel and connection part.)</li></ul>	

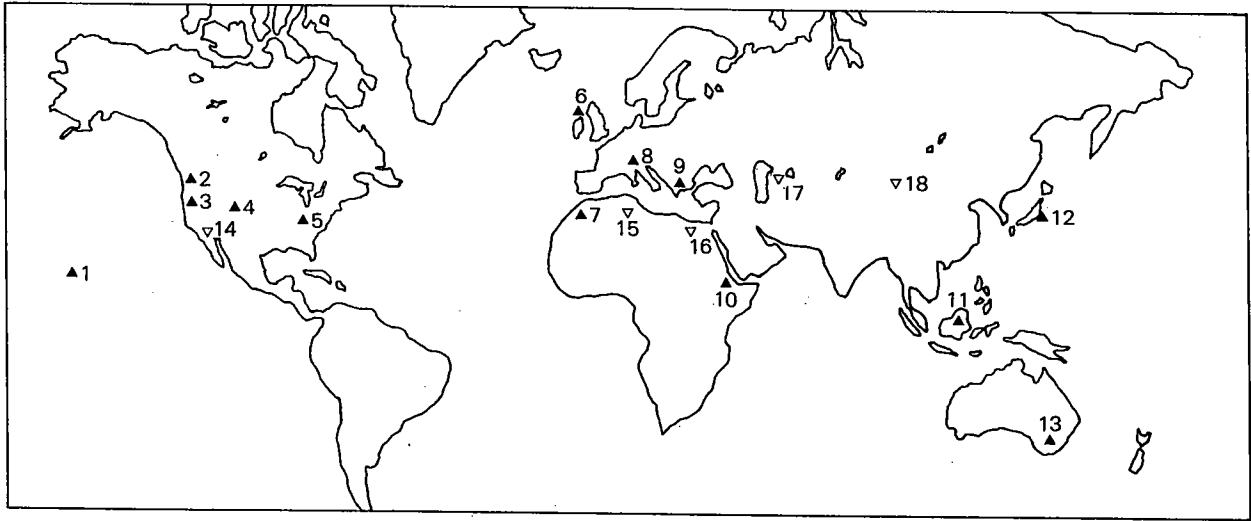

▲1 Mt. Mauna kea (U.S.A.) 4,205m	▲2 Mt. Rainier (U.S.A.) 4,392m	▲3 Mt. Shasta (U.S.A.) 4,317m	▲4 Mt. Elbert (U.S.A.) 4,398m	▲5 Mt. Mitchell (U.S.A.) 2,037m	▲6 Mt. Ben Nevis (SCOTLAND) 1,344m
▲7 Mt. Toubkal (MOROCCO) 4,165m	▲8 Matterhorn (SWITZER- LAND) 4,477m	▲9 Mt. Olympus (GREECE) 2,917m	▲10 Mt. Ras Dasham (ETHIOPIA) 4,620m	▲11 Mt. Kinabalu (MALAYSIA) 4,094m	▲12 Mt. Fuji (JAPAN) 3,776m
▲13 Mt. Kosciusko (AUSTRALIA) 2,230m	▼14 Death Valley (U.S.A.) -85m	▼15 Chotg Melrhir (ALGERIA) -24m	▼16 Qattara Depres- sion (EGYPT) -133m	▼17 Caspian Sea (U.S.S.R.) -28m	▼18 Turfan (CHINA) -154m

**CITIZEN WATCH CO.,LTD.**

Tokyo, Japan