

TECHNICAL INFORMATION

CITIZEN QUARTZ

Cal. No. A160

Cal. No. A270



(Cal. No. A160)



(Cal. No. A270)

 **CITIZEN**
CITIZEN IS A REGISTERED TRADEMARK OF CITIZEN WATCH CO., JAPAN.

Contents

§1. OUTLINE	1
§2. SPECIFICATIONS	1
§3. HANDLING OF WATCH	2
A. Solar Power Watch	2
B. Setting the Time and Calendar	2
C. Functions of the Sollar Power Watch	3
D. Time Required for Recharge	5
E. In These Cases	6
F. Care for Handling of Charge	6
G. Replacing the Secondary Battery	7
§4. PRECAUTIONS FOR DISASSEMBLY AND ASSEMBLY	7
1. How to Pull Out Setting Stem from One-piece Case	7
2. Precautions for removing and fitting the secondary battery strap	8
3. Precautions for removing secondary battery	8
§5. DISASSEMBLY AND ASSEMBLY OF MOVEMENT	9
§6. TROUBLESHOOTING AND ADJUSTMENT	11

§1. OUTLINE

This watch is an analog solar power watch which has a solar cell on its dial to convert optical energy into electric energy to drive itself.

§2. SPECIFICATIONS

Caliber NO.		A160	A270
Type		Analog solar power watch (Three hands)	
Movement size		ø30.4 × 5.6t	ø23.3 × 5.2t
Accuracy (At normal temperature)		±15 sec/month (+5°C~+35°C/41°F~95°F)	
IC		1 unit of C/MOS-LSI	
Operating temperature		-10°C~+60°C (14°F~140°F)	
Converter		Bipolar step motor	
Time adjustment		No adjustment terminal for use in market	
Measurement gate		10 sec.	
Additional functions	Date (With quick setting mechanism)	Installed	Not installed
	Quick start	Installed	
	Insufficient charge warning	Installed	
	Time setting warning	Installed	
	Over-charging prevention	Installed	
Continuous operating time	From full recharge to stop	Approx. 16 months	
	From two second interval movement to stop	Approx. 20 days	
Secondary battery	Part NO.	295-44	
	Remarks	Secondary battery block (With welded lead plate)	
Remark		For gentlemen	For ladie's

§3. HANDLING OF WATCH

A. Solar Power Watch

This watch is powered not by an ordinary battery, but by converting light energy into electrical energy.

A secondary battery is used in this watch to store electrical energy. **This secondary battery is a clean energy battery which doesn't use any toxic substances such as mercury. Once fully charged, the watch will continue to run for about 16 months without further charging.**

To use this watch comfortably, **make sure that the watch is always recharged before it finally stops.**

There is no concern for over-charging this watch. (Over-Charging Prevention Function is included)

Explain the user to expose the dial (solar cell) of this watch to light as long as possible.

B. Setting the Time and Calendar

1. Models without date display (CAL. No. A270)

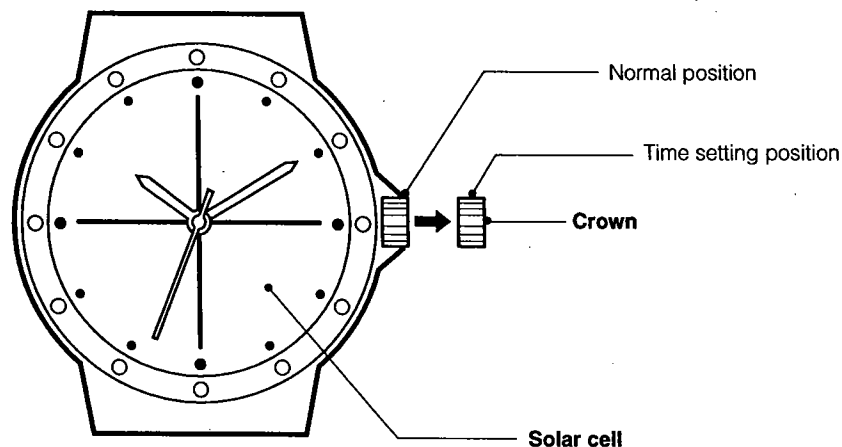

■ Setting the time

1. Stop the second hand at the 0 second position by pulling out the crown.
2. Turn the crown to set the time.
3. After setting the time, firmly push the crown back in to its normal position.

2. Models with date display (CAL. No. A160)

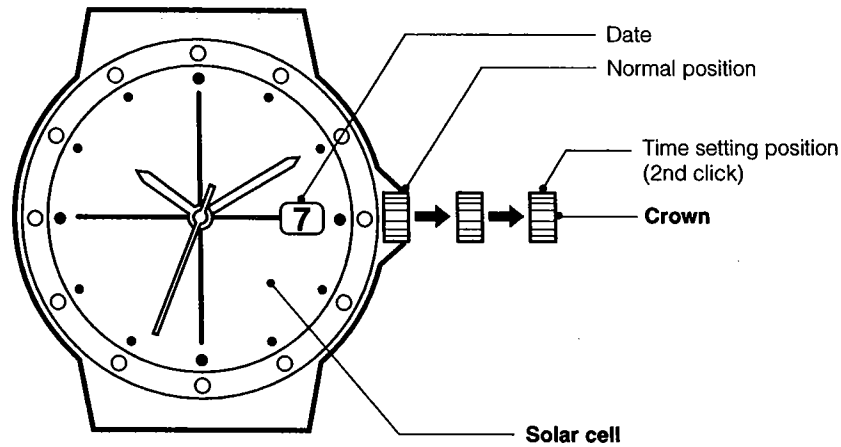

■ Setting the time

1. Stop the second hand at the 0 second position by pulling the crown out to the 2nd click.
2. Turn the crown to set the time.
3. After setting the time, firmly push the crown back in to its normal position.

■ Setting the calendar

Adjusting the date

1. Pull the crown out to the 1st click.
2. Set the desired date by turning the crown.
 - Do not adjust the date when the watch display is reading between 9:00 pm and 1:00 am, otherwise the date might not change on the following day.
3. After you have set the calendar, be sure to firmly return the crown to its normal position.

C. Functions of the Solar Power Watch

If the charge becomes insufficient, a warning function will operate and the display changes, as below.

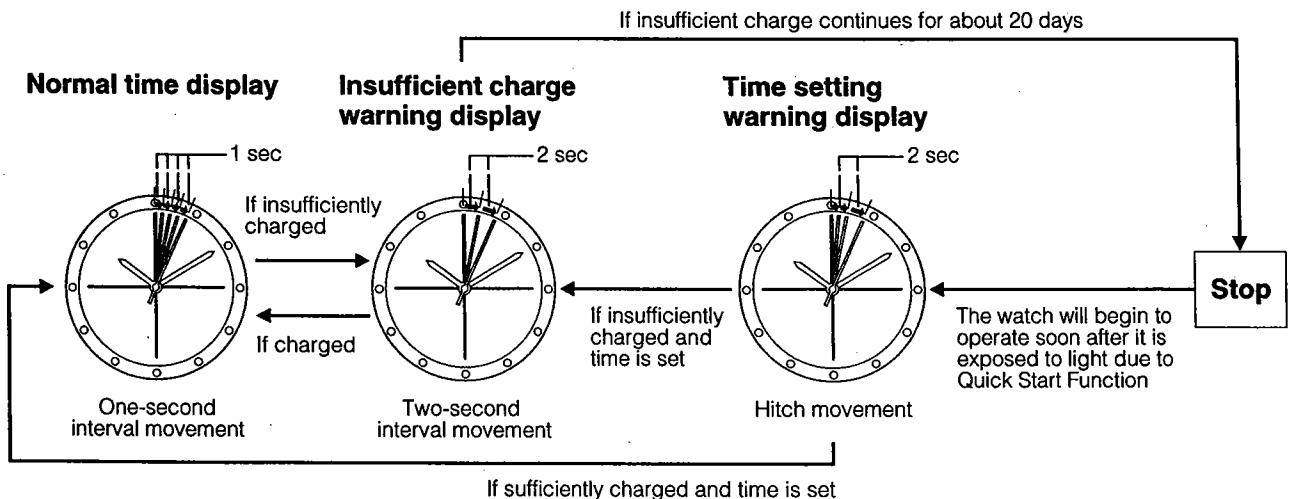

■ Insufficient Charge Warning Function

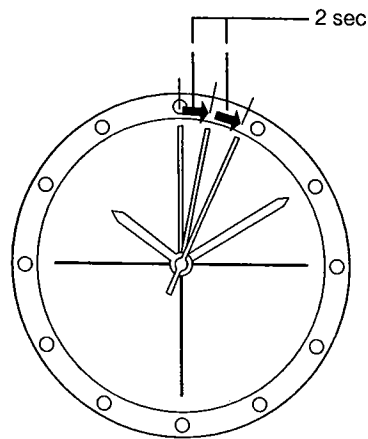

Two-second interval movement

The second hand changes to two-second interval movement to indicate insufficient recharging.

Even in such a case, the watch keeps correct time, but about 20 days after two-second interval movement begins, the watch will stop.

After exposing the watch to light, recharging takes place and the watch returns to one-second interval movement.

■ Quick Start Function

The watch will stop if it is completely discharged.

It will begin to operate soon after (within 10 second) it is exposed to light.

(However, the time to start may vary according to the brightness of the light.)

■ Time Setting Warning Function

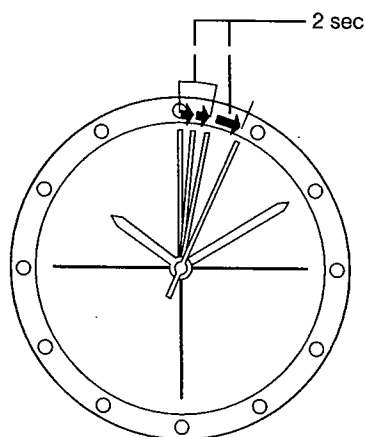

Hitch movement

If the watch stops, subsequent exposure to light allows the 'quick start' function to start again, and **the second hand moves with a hitch to indicate that the time incorrect.**

In this case, quickly recharge the watch and reset the time.

Even if the secondary battery is fully recharged, the hitch movement will continue, unless the time is reset and the crown is returned to the normal position.

■ Over-charging Prevention Function

Once the secondary battery is fully recharged, the overcharging prevention feature comes into operation and prevents over-recharging.

D. Time Required for Recharge

Time required for recharging may vary according to the caliber number, design (color of the dial, etc.) and operating environment. The following table will serve you as rough reference.

* The recharging time is the time when the watch is continuously exposed to radiation.

Please check the caliber number on the case back.

Caliber No. A160

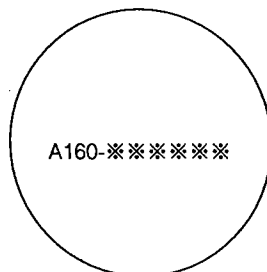

Full recharging timeThe time for fully recharge from stopped.
(Empty to full)

One day usage.....The time required for the watch to run for one day with one second interval movement.

Illuminance (lux)	Environment	Cal. No. A160		
		Time required		
		From the stop state to the one second movement	One day usage	Empty to full
500	Inside an ordinary office	12 days	2 hours	55 days
1000	60-70cm (24-28in.) under a fluorescent light (30W)	6 days	1 hour	27 days
3000	20cm (8in.) under a fluorescent light (30W)	46 hours	20 minutes	9 days
10000	Exterior, cloudy	14 hours	6 minutes	62 hours
100000	Exterior, summer, sunny	4 hours 30 minutes	2 minutes	22 hours

Illuminance (lux)	Environment	Cal. No. A270		
		Time required		
		From the stop state to the one second movement	One day usage	Empty to full
500	Inside an ordinary office	19 days	3 hours	85 days
1000	60-70cm (24-28in.) under a fluorescent light (30W)	9 days	1 hour 30 minutes	41 days
3000	20cm (8in.) under a fluorescent light (30W)	70 hours	30 minutes	14 days
10000	Exterior, cloudy	21 hours	9 minutes	96 hours
100000	Exterior, summer, sunny	7 hours	3 minutes	32 hours

E. In These Cases

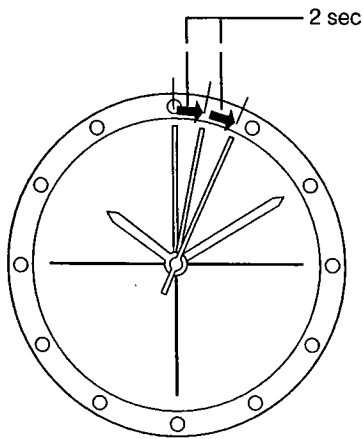

Two-second interval movement

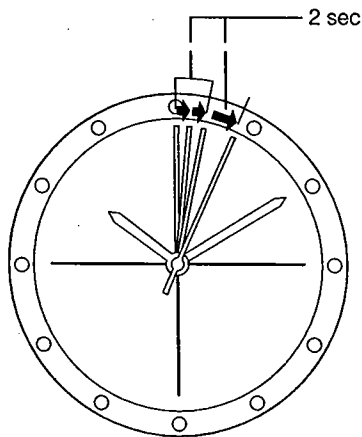

Hitch movement

[If the watch warns that the energy is running short]

The second hand starts moving at two-second increments in order to warn that the watch will stop functioning after about 20 days. **(Insufficient charge warning function)**

In such a case, expose your watch to light for a while to cancel the warning. (The second hand returns to the movement at one-second increments when the energy is recharged.)

If the watch is left short of energy, it will stop functioning after about 20 days or so.

[If the watch warns you to set the time.]

When the watch that has stopped is exposed to light, the second hand starts hitch movement. **(Quick start function)**

The time elapsed before the second hand restarts moving depends on the illuminance of the light.

After this also, the second hand keeps hitch movement to show that the watch indicates an incorrect time because it once stopped. **(Time setting warning function)**

In such a case, set the hands to the correct time.

* If the watch is insufficiently exposed to light, the second hand will soon switch to the movement at two-second increments in order to warn that the energy is running short.

F. Care for Handling of Charge

■ Notes on Use <Give the following precaution and explanation to the user.>

Take care to charge during use.

Please note that if the user wears long sleeves, the watch can easily become insufficiently charged because it is hidden and not exposed to light.

- When the user takes off the watch, it should be placed in as bright a place as possible, and it will always continue to run properly.

■ Notes on Recharge

- Avoid recharging at high temperatures (over about 60°C/140°F), otherwise the watch will be damaged during recharging.

(eg) Charging the watch near a light source that easily becomes hot, such as an incandescent lamp or a halogen lamp.

Charging in a place that easily becomes hot, such as a dashboard.

When the user charge the watch by an incandescent lamp, take a distance about 50cm (20in.) from the light source to prevent extremely high temperature.

G. Replacing the Secondary Battery

This watch uses the secondary battery, which does not have to be periodically replaced due to repeated charging and discharging, unlike ordinary batteries.

Caution

Never use a battery other than the secondary battery used in this watch.

The watch structure is so designed that a different kind of battery other than the specified cannot be used to operate it. In case a different kind of battery such as a silver battery is used by some chance, there is a danger that the watch will be overcharged to burst, causing damage to the watch and even to the human body.

§4. PRECAUTIONS FOR DISASSEMBLY AND ASSEMBLY

1. How to Pull Out Setting Stem from One-piece Case

(1) When removing the setting stem from the case

- Pressing down the end of the unlocking lever for setting stem from above, pull out the setting stem.

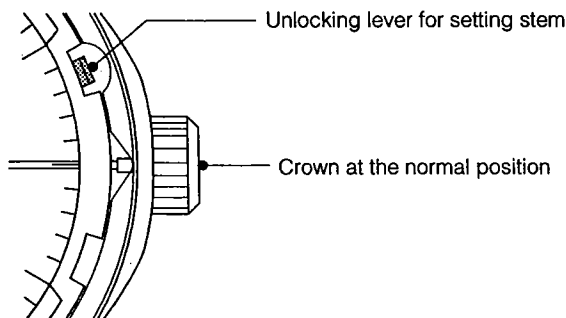

<Procedure>

- (1) Set the crown at the normal position (Push it in).
- (2) Lightly press the end of the unlocking lever for setting stem with a screwdriver, etc. from above.
- (3) With the lever pressed, pull out the setting stem.

(2) When removing the setting stem from the movement

- Pressing the base of the unlocking lever for setting stem ("PUSH →" position), pull out the setting stem.

<Note>

When the movement has been removed from the case, do not press the end of the unlocking lever for setting stem. If it is pressed in this case, it may be pressed too much to deform itself, circuit unit supporter, etc. since there is not a stopper.

If the movement is installed to the case with any part deformed, the setting stem may not be pulled out even if the unlocking lever for setting stem is pressed.

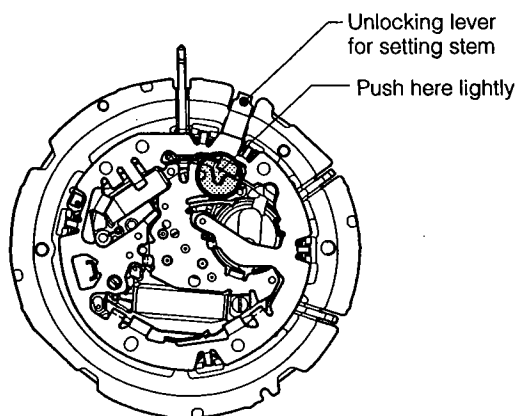

<Procedure>

- (1) Remove the secondary battery strap, secondary battery and insulator for secondary battery.
- (2) Set the crown at the normal position (Push it in).
- (3) Lightly press the base of the unlocking lever for setting stem ("PUSH →" position) with a screwdriver, etc. from above.
- (4) With the lever pressed, pull out the setting stem.

2. Precautions for removing and fitting the secondary battery strap

<How to remove secondary battery strap>

- (1) Insert tweezers in hole ① of the secondary battery strap and shift the battery strap in the direction of the arrow.
- (2) Insert tweezers, etc. in the hook of the circuit unit supporter of the battery strap (② in the figure), and open the hook lightly to remove the battery strap.

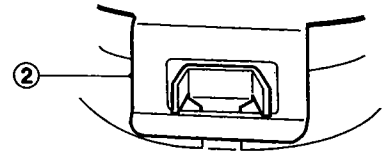
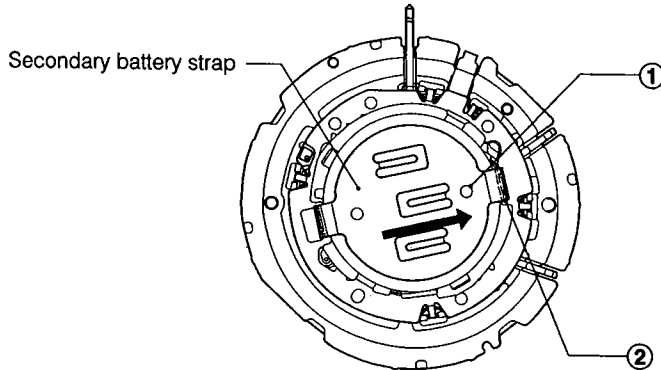

<How to install secondary battery strap>

Hitch one of the hooks of the battery strap to the hook of the circuit unit supporter, then hitch the other hook securely. Then, confirm that both hooks are hitched securely.

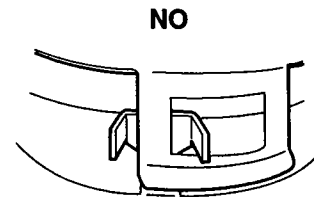
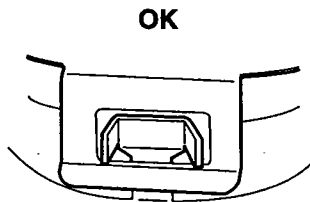

3. Precautions for removing secondary battery

<How to remove secondary battery>

- (1) Remove the secondary battery strap.
- (2) Pry up the secondary battery with a screwdriver, etc. as shown in the figure (between 6 o'clock and 9 o'clock)

☆ When inserting the secondary battery, set it with the long side of lead plates ahead.)

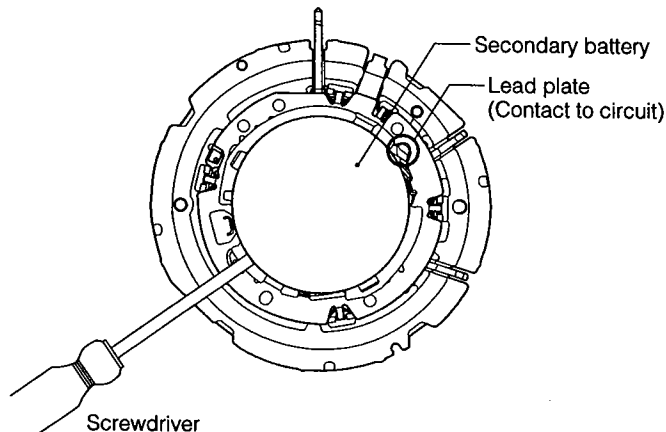

* The lead plate welded to the secondary battery reaches the underside of the circuit. Accordingly, if the secondary battery is removed from the lead plate side, the lead plate may be deformed. Take care.

§5. DISASSEMBLY AND ASSEMBLY OF MOVEMENT

Disassembly procedure: ① → ③⑤
 Assembly procedure: ③⑤ → ①

● Lubrication mark

- Ⓐ : A-Lube oil
- Ⓥ : V-Lube oil
- ⓕ : F-Lube oil
- Ⓞ : CH-1 oil

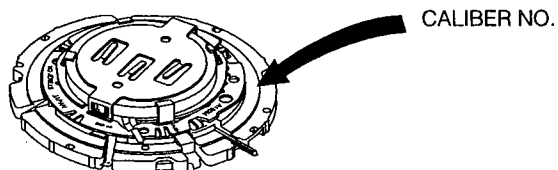
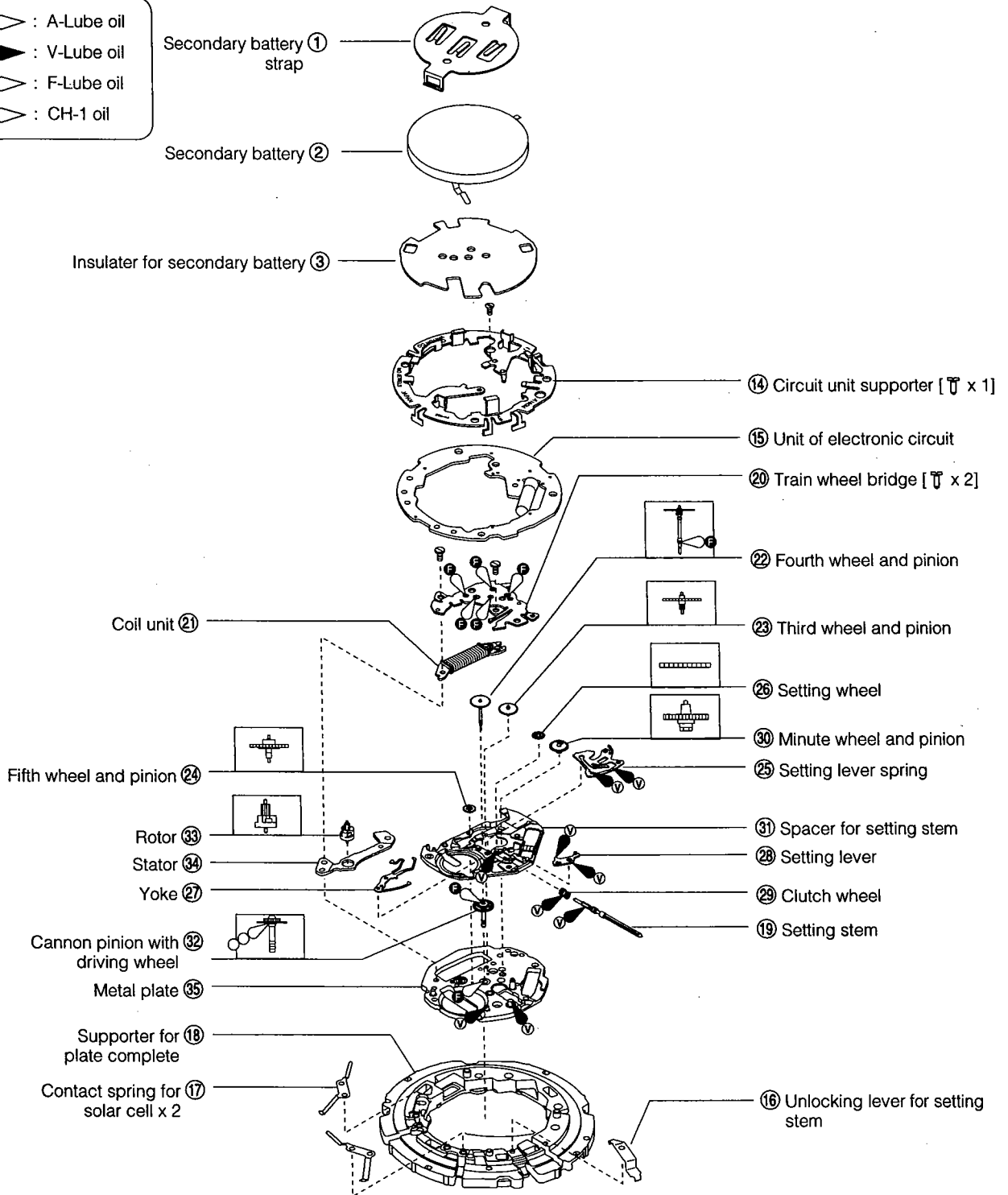

* This illustration is for Cal. A160.
 Some parts for Cal. A270 are different from those of Cal. A160.

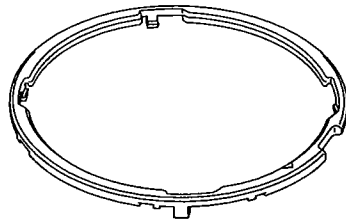

④ Support ring for solar cell

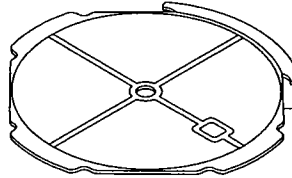

⑤ Solar cell

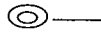

⑥ Dial washer

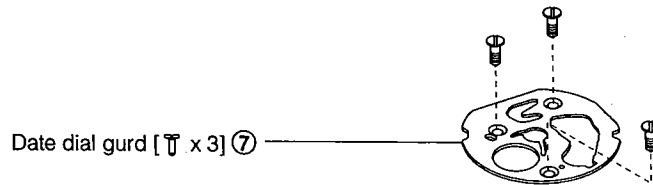

Date dial gurd [3 x 3] ⑦

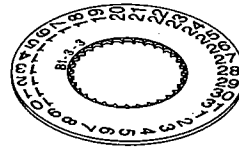

⑨ Date dial



⑫ Lower plate



⑧ Date jumper



Hour wheel ⑬

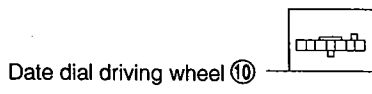

Date dial driving wheel ⑩

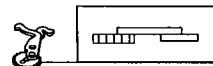
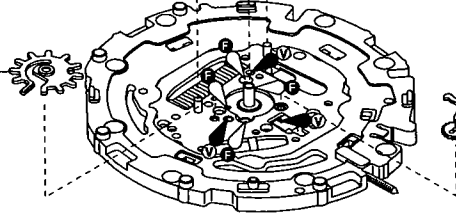

⑪ Date corrector lever

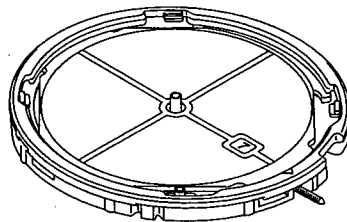

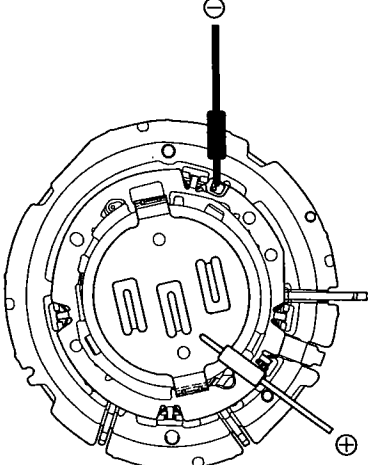
Check Items	How to Check	Results and Treatments
<p>① Measurement of secondary battery voltage</p>	<p style="text-align: right;"><Tester range: DC. 3V></p>  <p>Reference:</p> <ul style="list-style-type: none"> • 0.9V ~ 1.3V: Two-second interval movement mode • 1.3V ~ 2.6V: One-second interval movement mode <p>These voltages may vary slightly from watch to watch.</p> <ul style="list-style-type: none"> • Hitch movement is a function that signals that the watch has stopped and restarted. This mode will continue until the watch is set to the correct time, irrespective of the voltage. • A quick-start is activated by the small-capacity tantalum capacitor which has been incorporated in the circuit, in addition to the primary secondary battery. After the watch is illuminated (right after it begins running), the secondary battery voltage will display an extremely low value because the secondary battery has not been fully charged. <div style="border: 1px solid black; padding: 5px; margin-top: 10px;"> <p>Note: When measuring the voltage, be careful not to place the ⊖ tester pin on the secondary battery strap (a short circuit will occur.)</p> </div>	
<p>② Confirmation of output signal</p>	<p>Since the output pattern is hidden under the secondary battery, the output signal cannot be checked with a tester. Check the output signal according to the following procedure.</p> <ol style="list-style-type: none"> 1) Confirmation of transmission (SIGNAL) <ul style="list-style-type: none"> • Confirm with a time rate tester that the watch is transmitting. 2) Measurement of coil resistance <ul style="list-style-type: none"> • Measure the coil resistance. 	<ul style="list-style-type: none"> • Watch is transmitting. → Normal. • Watch is not transmitting. → Check coil resistance. • Coil resistance is normal. → Check connections. • Connections are normal. → Replace the electronic circuit.

Check Items	How to Check	Results and Treatments
<p>③ Check of connection parts</p>	<p>* Refer to Technical Manual, Basic Course: II-2-a.</p> <ul style="list-style-type: none"> • Check for looseness of screws, dust, stain, etc. • Check for stain and removal of the solar cell pattern (two places), deformation of connection spring, removal of welded lead plate of the secondary battery, stain of the circuit pattern, bad contact of each part. 	<p>Stain of solar cell pattern and circuit pattern. → Remove stain.</p> <p>Removal of solar cell pattern, removal of circuit pattern, removal of welded lead plate of secondary battery. → Replace parts.</p>
<p>④ Measurement of coil resistance</p>	<p>* Refer to Technical Manual, Basic Course: II-1-c.</p> <ul style="list-style-type: none"> • Remove the unit of electronic circuit and measure the coil resistance <p style="text-align: right;"><Tester range: R x 10Ω></p> <p><The tester lead pins have no polarity></p>	<ul style="list-style-type: none"> • 1.4 kΩ - 2.0 kΩ → Normal • Out of above range → Replace coil unit
<p>⑤ Check of train wheel</p>	<p>* Refer to Basic Course: II-2-b.</p>	
<p>⑥ Check of dial side mechanism</p>	<p>* Refer to Basic Course: II-2-c.</p>	
<p>⑦ Check of solar cell</p>	<ul style="list-style-type: none"> • Check the solar cell for breakage and stain, and check its electrode for stain and flaking. 	<p>Breakage of solar cell → Replace solar cell.</p> <p>Stain → Remove stain.</p> <p>Flaking of electrode → Replace solar cell.</p>
<p>⑧ Measurement of time rate</p>	<p>* Refer to Basic Course: II-2-d.</p> <p style="text-align: right;"><Measurement gate: Analog 10 sec></p> <ul style="list-style-type: none"> • The time rate cannot be adjusted. • The time rate may not be measured accurately in the 2-second interval movement or hiton movement. In this case, apply light to the watch until the second hand moves in the 1-second interval movement mode, then measure the time rate. 	<ul style="list-style-type: none"> • The watch loses or gains substantial time → Replace the electronic circuit

Check Items	How to Check	Results and Treatments
<p>⑨ Confirmation of using condition</p>	<p>* Refer to Basic Course: II-2-e.</p> <ul style="list-style-type: none"> • Since this watch is energized by light, it should receive light as much as possible. If the watch is placed near a light source which generates heat (above 60°C) such as an incandescent lamp, a halogen lamp, etc., its functions and parts may be deteriorated or deformed by the heat. Accordingly, take care when applying light to it. <p>Example: When the watch is hidden under a long sleeve or the customer works in a dark place, it needs to be exposed to light on purpose.</p>	
<p>⑩ Measurement of current consumption</p>	<p>* Refer to Technical Manual, Basic Course: II-1-f.</p> <ul style="list-style-type: none"> • This watch uses the secondary battery block, instead of a ordinary battery. Accordingly, prepare a silver battery (1.55V) and measure the current consumption according to the following procedure. <ol style="list-style-type: none"> (1) Remove the secondary battery strap, secondary battery and insulator for secondary battery. (2) Referring to Technical Manual, Basic Course, set the silver battery (1.55V) to the adapter of the tester correctly. (3) Pull out the crown. (4) Set the tester. <div data-bbox="613 1115 987 1535" style="text-align: center;"> </div> <p style="text-align: center;"><Tester range: DC 10μA></p> <ol style="list-style-type: none"> (5) Return the crown to the normal position and measure the current consumption of the movement. <div data-bbox="480 1696 1110 1871" style="border: 1px solid black; padding: 5px; margin-top: 10px;"> <p>Note: When measuring the current consumption, do not apply any light to the solar cell. If any light is applied, the voltage changes and correct current consumption cannot be measured.</p> </div>	<ul style="list-style-type: none"> • Current consumption of the movement Under 1.4μA → Normal • Over 1.4μA → Check train wheel and dial-side mechanism. → Remove dust and dirt. <p style="text-align: center;">↓</p> <ul style="list-style-type: none"> • Current consumption measured again Over 1.4μA → Replace the electronic circuit.

Check Items	How to Check	Results and Treatments
① Check of appearance and function	* Refer to Basic Course: II-2-f.	