

***TECHNICAL
INFORMATION***

**CITIZEN QUARTZ
Cal.No.79※※※**

§1. OUTLINE

(Except Cal. 7900*)



The Cal. Nos 7930E (center second) and 7920E (excluding center second) are full-dress and high-ranking quartz crystal watches of analog type for gentlemen's use.

It features the highest level both in the function and the design as well as an ultra-slim structure of the movement.

§2. MAIN FEATURES

- 1) **High-class and ultra-slim type analog quartz crystal watch for gentlemen**
The movement measures only 1.95mm thick, and the total thickness including the power cell is just 2.5mm.
- 2) **High accuracy produced by an ultra small-size quartz crystal oscillator**
A high accuracy of ± 5 seconds per month (in normal temperatures) is ensured thanks to the high and stabilized oscillations produced by an ultra small-size quartz crystal oscillator plus the temperature compensation circuit.
- 3) **High-output step motor**
The step motor, manufactured through a new process, is small in size yet high in output of power.
- 4) **About 2 years of power cell life**
A high-accuracy timekeeping is ensured about 2 years by just one unit of the small-size silver oxide power cell. This is possible thanks to the low power consumption of the electronic circuit and a high conversion efficiency of an excellent step motor.
- 5) **Power conservation switch**
When the crown is pulled out to the time-setting position, the reset switch functions to cut off the current supply to the converter although the quartz crystal oscillator keeps actuation. As a result, the amount of power consumption can be reduced down to a half or less.
- 6) **Power cell life indicating device (only for 7930E)**
When the life of the power cell comes near its end, the normal 1-second step movement of the second hand changes to the 2-second step movement indicating the replacement of the power cell. In this case, however, the time is still kept correctly.
- 7) **Second hand stopping device (only for 7930E)**
The second hand stops at an optional position when the crown is set at the time-setting position, thus the correct time being set down to a second.

§3. SPECIFICATIONS

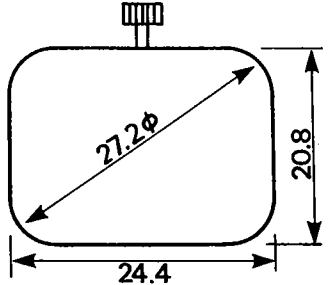
Caliber No.	7920E/7930E (7 jewels)
Type	Analog-type quartz crystal watch: 7930E (center second); 7920E (excluding center second)
Movement	<p>Size: 24.4 x 20.8 x 27.2ϕmm</p> <p>Thickness: 1.95mm 2.5mm (including power cell)</p> 
Accuracy	± 5 sec./month (in normal temperatures)
Oscillation	32,768 Hz
Effective temperature range	$-10^{\circ}\text{C} \sim +60^{\circ}\text{C}$ ($14^{\circ}\text{F} \sim 140^{\circ}\text{F}$)
Integrated circuit	C/MOS-LSI (1 unit)
Converter	Bipolar step motor
Additional mechanisms	<ul style="list-style-type: none"> ●Power conservation switch ●Power cell life indicating device (only for 7930E) ●Second hand stopping device (only for 7930E)
Power cell	<p>Small-size silver oxide power cell (1 unit)</p> <p>Parts No. : 280-27 Voltage : 1.5V Capacity : 38mAH Size : 11.6ϕ x 2.1mm Life : About 2 years</p>

§4. HANDLING INSTRUCTIONS

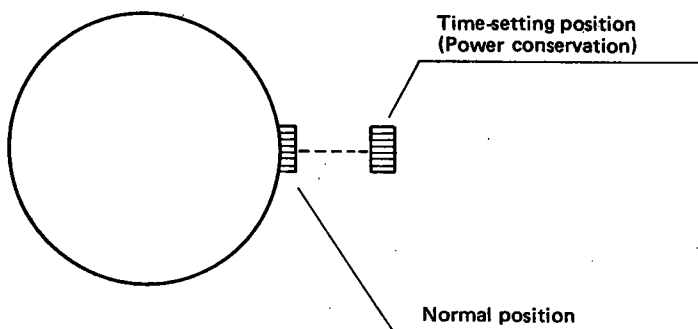

- 1) The handling method of these watches is just same as other analog-type quartz watches (center second or excluding center second).
- 2) The hands are set by pulling out the crown. In this position of the crown, the power conservation switch is also actuated.

§ 5. STRUCTURE OF MOVEMENT

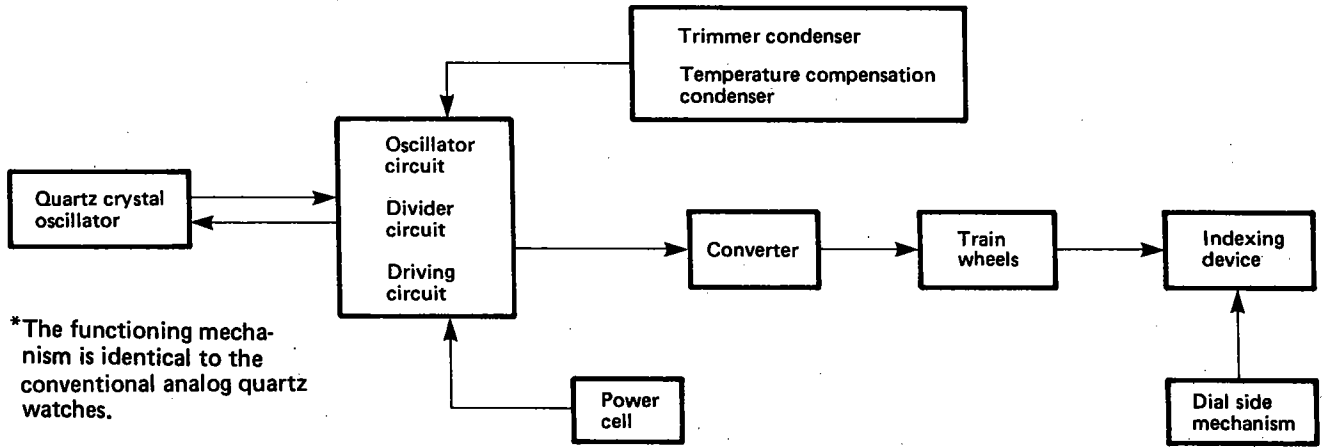

(Block Diagram of Movement)

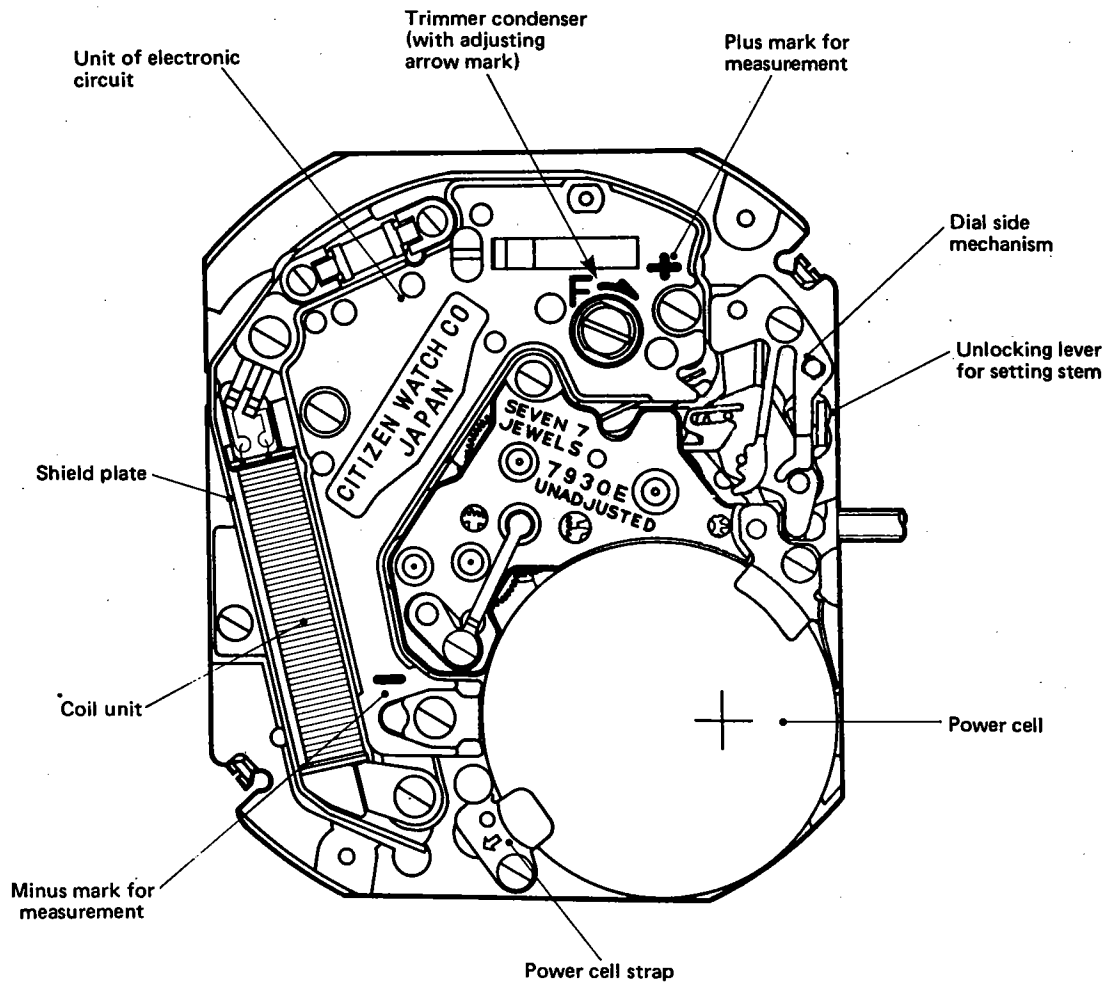



(Plan of Movement)

§6. DISASSEMBLY AND ASSEMBLY OF MOVEMENT

1) Dial side

Disassembling sequence: ① ~ ②⑧
 Assembling sequence: ②⑧ ~ ①
 The number of the screw coming with the parts is shown by the symbol like (T 1).

Lubrication mark:

-  Synt-A-Lube oil
-  Synt-V-Lube oil
-  Citizen watch oil CH-1

Note:

Avoid washing the electronic parts. Clear away the dust and stains stuck to the parts to secure a good contact.

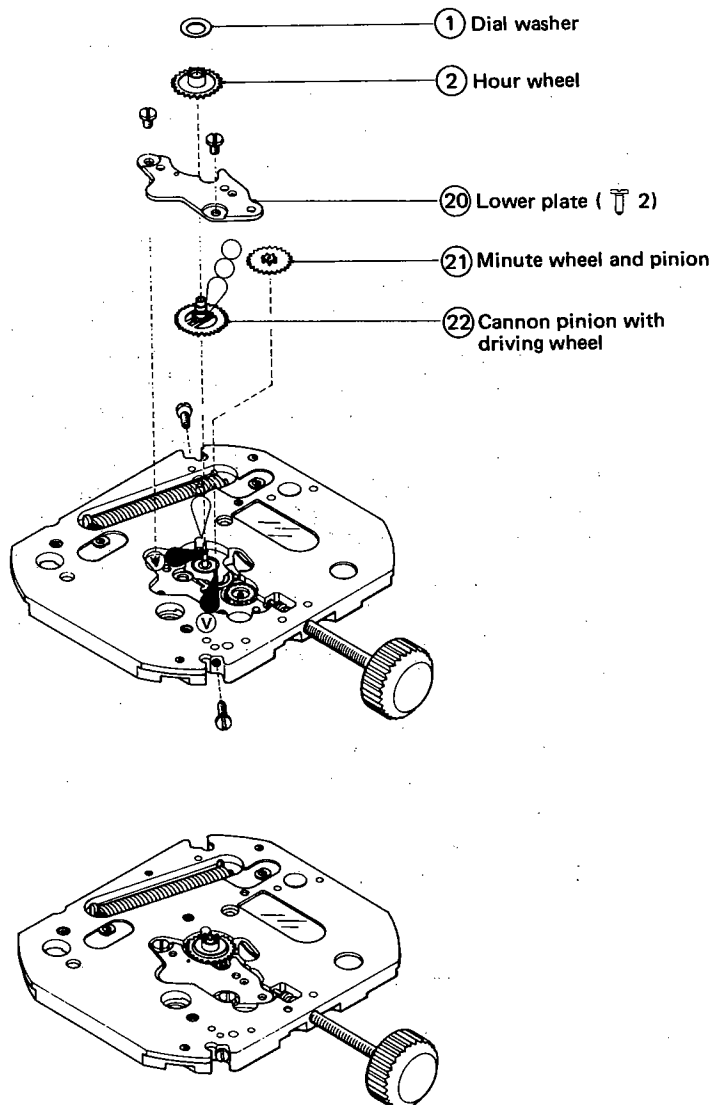

2) Power cell side

The power cell insulator is incorporated while being slid laterally after the notch part is fitted to the minus (-) lead plate.

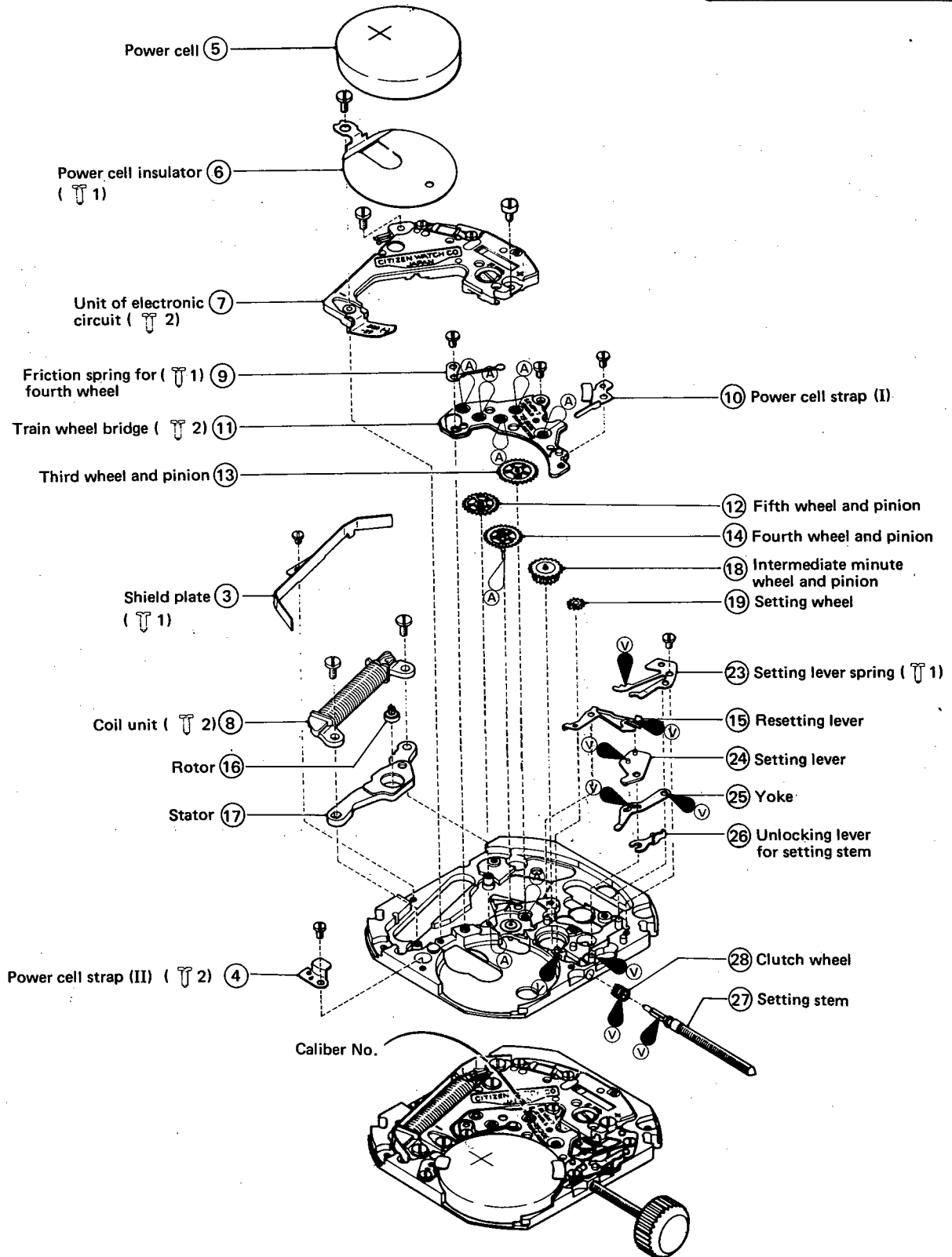

§7. TROUBLESHOOTING AND ADJUSTMENT

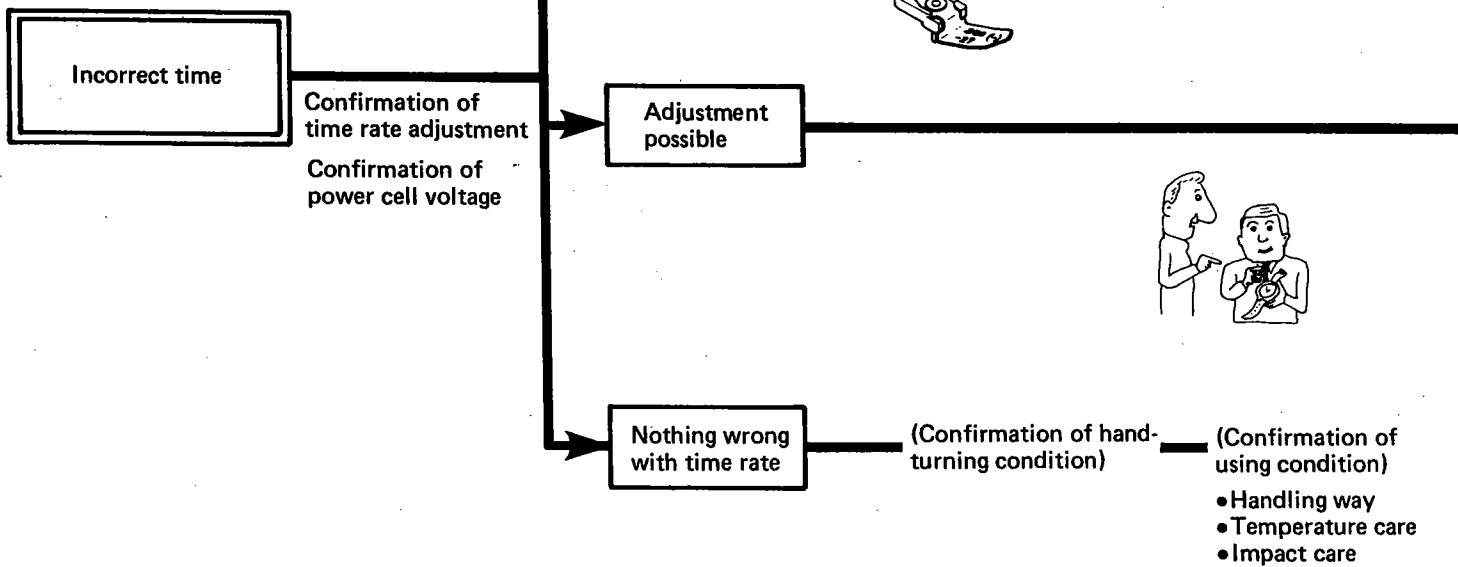
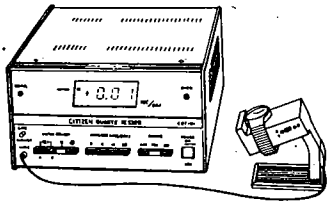
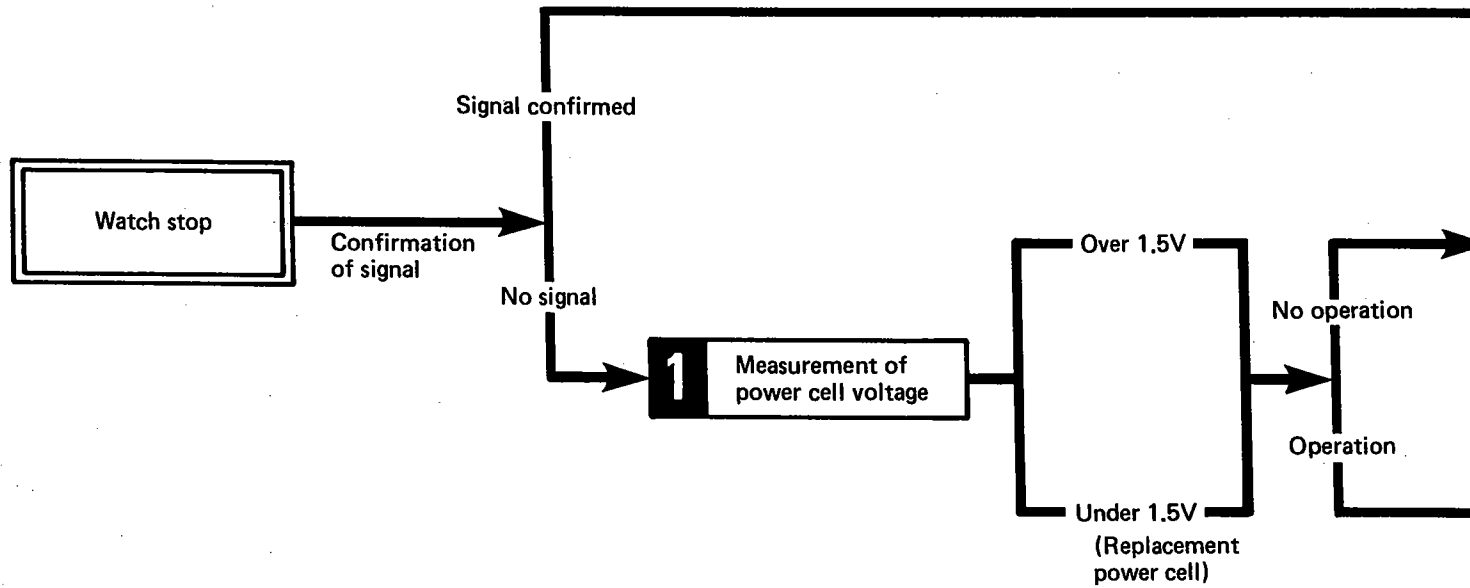

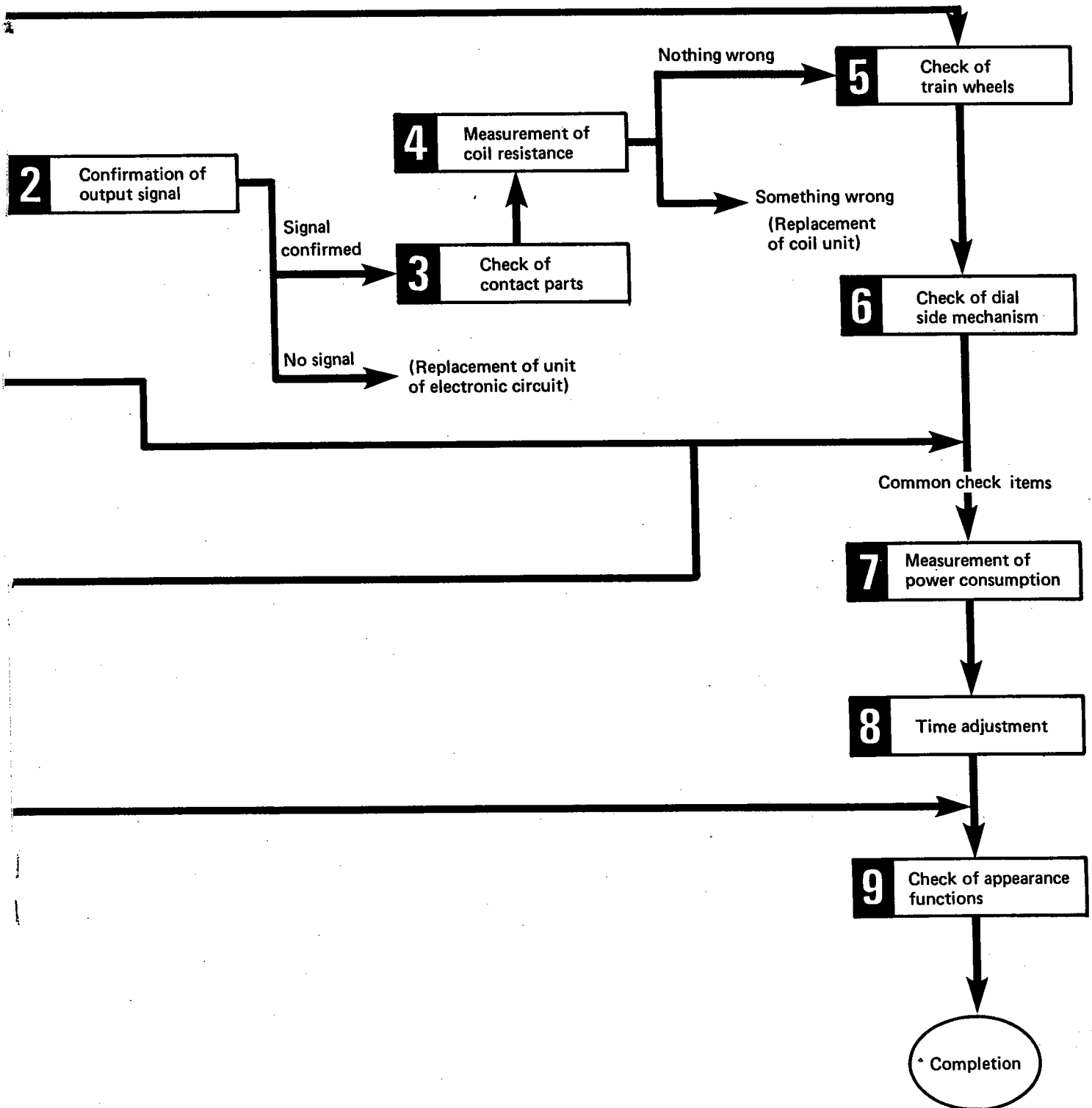

1 Measurement of power cell voltage

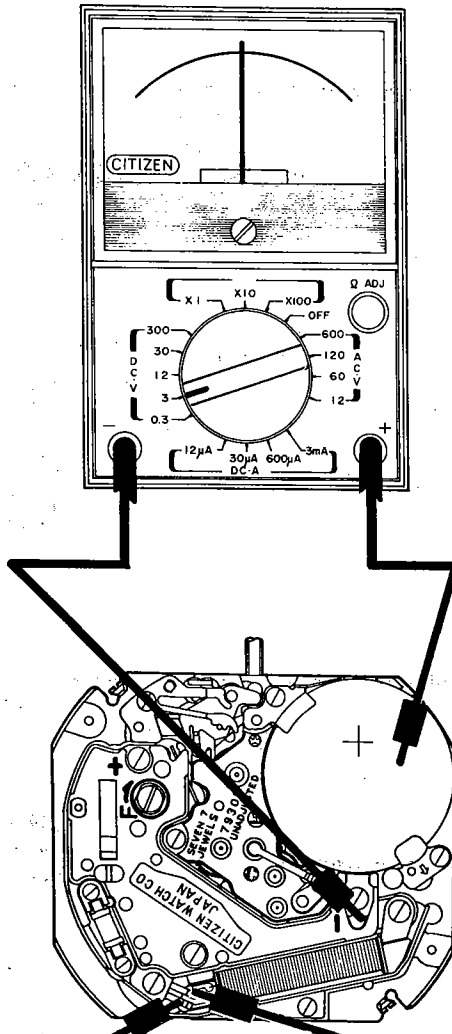

Results and Treatment

Over 1.5V
 → Nothing wrong

Under 1.5V
 → Replacement of power cell

2 Confirmation of output signal

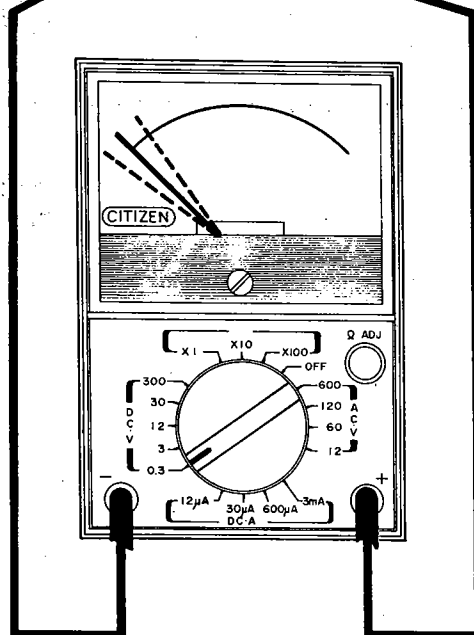

Results and Treatment

Confirmation of output signal with power cell incorporated:

Tester pointer goes and comes back every second.
 → Nothing wrong

Something wrong recognized
 → Replacement of unit of electronic circuit

*The measurement becomes easy with the shield plate removed.

Check items	How to check	Results	Treatment
3 Check of contact parts	<ul style="list-style-type: none"> • Check whether any dust or stain stick to the contact between the coil terminal and the unit of electronic circuit. • Check whether the screws are loose for the unit of electronic circuit. 	Dust or stain stuck Screws loosened	→ Clearing → Retightening

4 Measurement of coil resistance

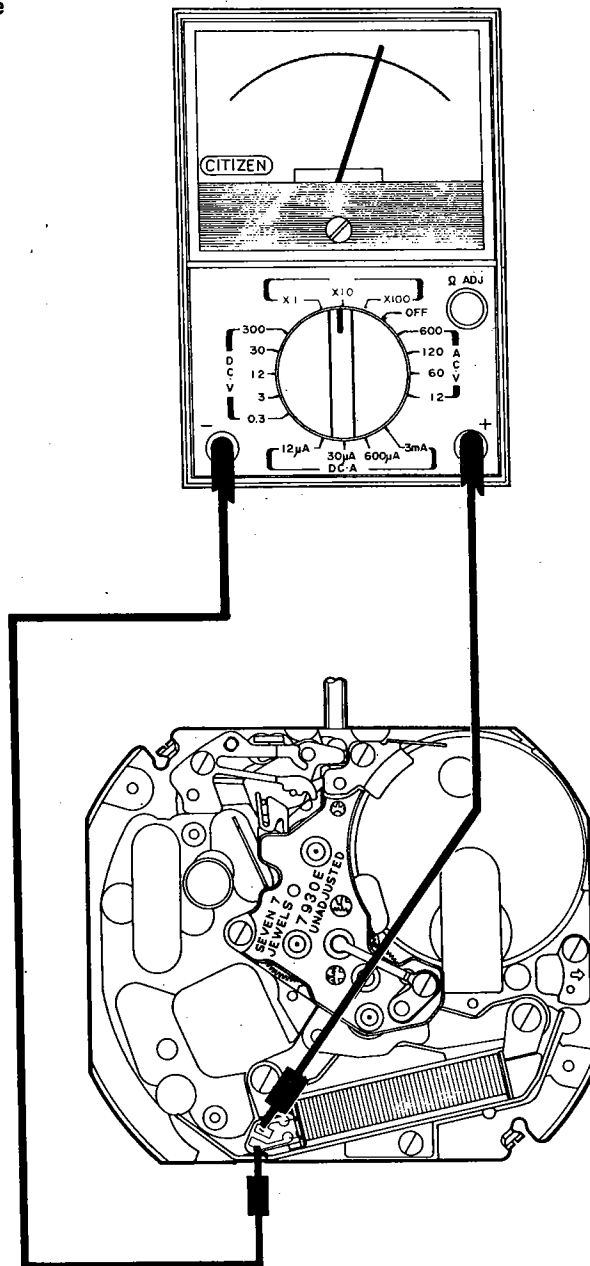

Results and Treatment

3.2 ~ 4.0KΩ

→ Nothing wrong

Disconnection is conceivable in case measurements is $\infty \Omega$.

Short circuit is conceivable in case measurements is 0Ω .

→ Replacement of coil unit in both cases

*When measuring the coil resistance, the unit of electronic circuit is removed and the tester terminals are applied as shown in the above diagram.

Check items	How to check	Results	Treatment
5 Check of train wheels	<ul style="list-style-type: none"> • Check whether the transmission is smooth or not with each wheel. (How about the play and creaking?) • Check whether the amount of oil is appropriate. • Check whether any dust or other foreign substances stick to wheels. 	Creaking detected Incorrect play Dust and others stuck	→ Replacement of wheel → make clearance → Clearing
6 Check of dial side mechanism	<ul style="list-style-type: none"> • Check whether the cannon pinion with driving wheel has a proper slip. 	Lack of oil Slip too strong Slip too weak	→ Lubrication of CH-1 oil → Replacement of driving wheel → Replacement of driving wheel

7 Measurement of power consumption

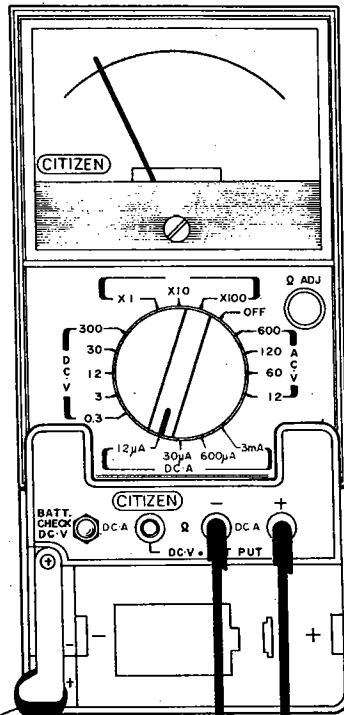

Power cell

Results and Treatment

Under 2.5 μ A

→ Nothing wrong

→ Something wrong recognized

→ Replacement of unit of electronic circuit

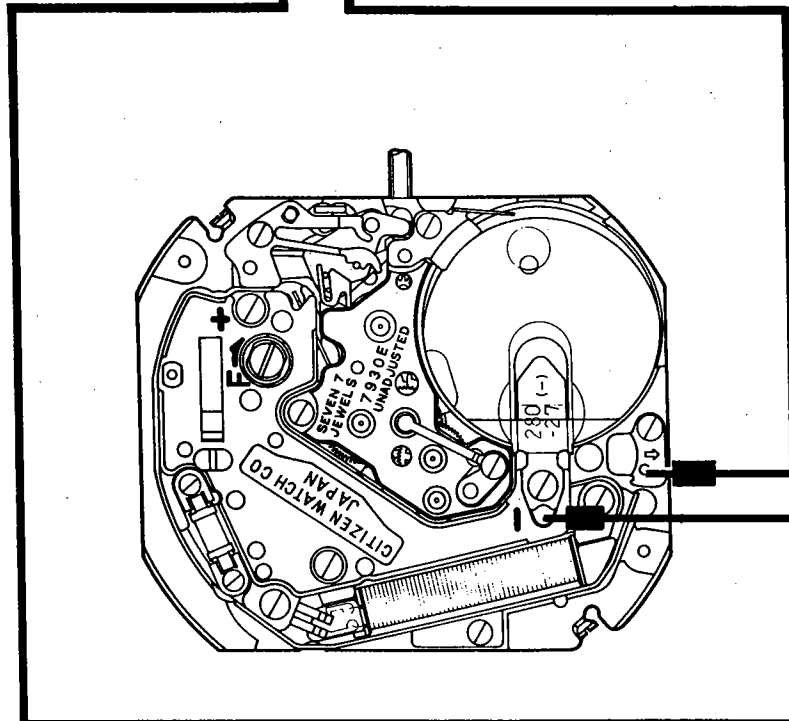

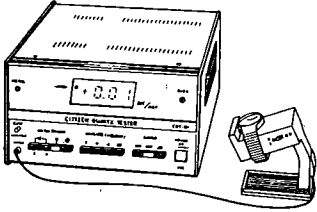
Check items	How to check	Results	Treatment
8 Time adjustment	<ul style="list-style-type: none"> The time rate is measured using a timing machine, and the time is adjusted by means of the trimmer condenser.  <p>The diagram shows a timing machine on the left and a watch movement on the right. A line points from the text 'Trimmer condenser (Clockwise turning: gain.)' to a specific component on the watch movement.</p> <p>Trimmer condenser (Clockwise turning: gain.)</p>		
9 Check of appearance functions	<ul style="list-style-type: none"> Check whether the second hand has an accurate step movement (only for 7930E). Make sure the minute hand moves after a little interval. Check whether any dust or other foreign substances stick to the movement or the dial. Check the additional mechanisms such as the second hand stopping device and others. 		

CITIZEN WATCH CO., LTD.
Tokyo, Japan