

***TECHNICAL
INFORMATION***

**CITIZEN QUARTZ
Cal.No.71 ※※※**

 **CITIZEN**

1. OUTLINE



The Citizen Quartz "71-series" is a thin-type analog watch for gentlemen, featuring an extremely high accuracy as well as various kinds of full functions. It can accordingly meet the versatile requirements of users.

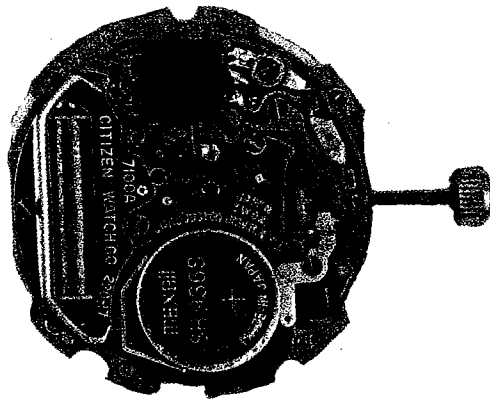

Movement
(Quartz crystal oscillator side)

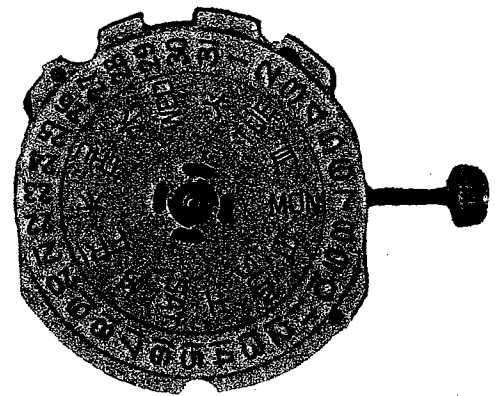

Movement
(Dial side)

2. MAIN FEATURES

1. Thin-type analog quartz watch:

The movement is completed into a thin thickness thanks to the compactness of IC, crystal and other component parts which are grouped into several blocks.

2. Second hand stopping at optional positions:

With the crown set at the time setting position, the second hand stops at an optional position. Thus, the time can be set correctly down to a second.

3. Power-conservation switch:

The power-conservation switch is actuated when the crown is set at the time setting position, thus extending the life of the power cell.

4. Continuous operation of about two years with a single unit of power cell:

Thanks to the electronic circuit driven by a low voltage and low current plus the step motor of a high energy conversion efficiency, the watch can operate continuously and accurately for about two years on just a single unit of small-size silver oxide power cell.

5. Power cell life indicating device:

When the power cell comes near the end of its life time, the normal 1-second step movement of the second hand is changed to the 2-second step movement indicating the replacement of the power cell. Even in this case, the watch keeps a correct time.

6. Second resetting device:

The gain or loss can be corrected easily down to a second by operating the second resetting button located at the 8-o'clock position.

7. Simplified disassembly, assembly and adjustment:

Owing to a reduced number of the component parts, the assembly, disassembly and adjustments are simplified greatly for the movement.

3. HANDLING INSTRUCTIONS

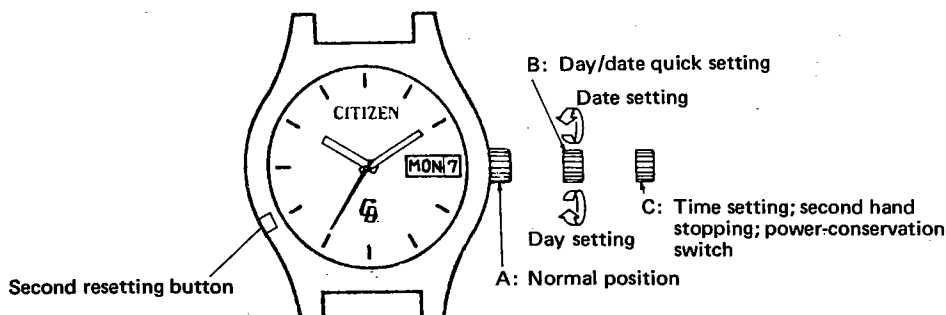

1. Time setting

Pull out the crown to C position, and turn the crown to move the hands to set to the correct time by making sure the AM and PM. The time when the date changes at 12 o'clock indicates the 12 mid-night.

2. Push the crown lightly, and the watch starts.

3. Day/date setting

Turn the crown counterclockwise at B position to set the date, and turn it clockwise to set the day. The day can be displayed bilingually, so choose either one language first, and the selected language is then displayed continuously.

4. Push in the crown until it stops when finishing the setting procedures. The day and date change automatically while using the watch.

5. Second resetting device

The gain or loss can be corrected easily by means of a second resetting button located at the 8 o'clock position.

Gain correction:

Keep pushing the second resetting button during the time equivalent to the seconds gained. The second hand starts again in one second after releasing the button.

Loss correction:

Push and release the second resetting button until the same frequency is obtained as the seconds lost. (The time gains by one second with every push of the button, without pushing the button continuously.)

4. STRUCTURE AND FUNCTION

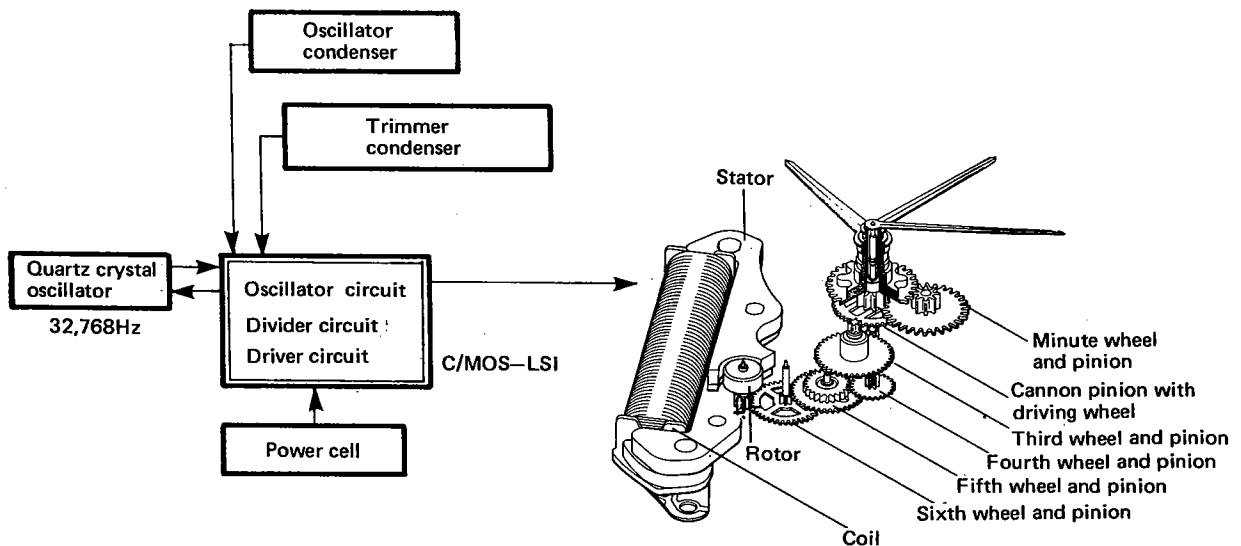

1. Driving mechanism

A high and stable oscillation of 32,768Hz produced by a quartz crystal oscillator is divided down to 1Hz through a divider circuit.

The pulse divided down to 1Hz is amplified enough through a divider circuit to drive the rotor, and is also converted to a plus and minus pulses alternately every second.

With these converted pulses, the step motor is actuated. The step motor consists of a driving coil, a stator and a rotor.

The rotor, comprising a permanent magnet of Sm-Co (samarium-cobalt), contains two poles (a pair) magnetized at the outer circumference. A stator given a stage difference adjustment is provided as if it covered the outer circumference of the rotor. Each stator is pressure-bonded across the core of a driving coil to form a magnetic path. And the plus and minus pulses flowing to the driving coil convert the magnetic pole of the stator into the N and S poles alternately.

Owing to this intermittent conversion of the magnetic pole occurring at the rotor, the rotor has a repulsion and an attraction in order to produce an instantaneous rotation by 180° in a fixed direction.

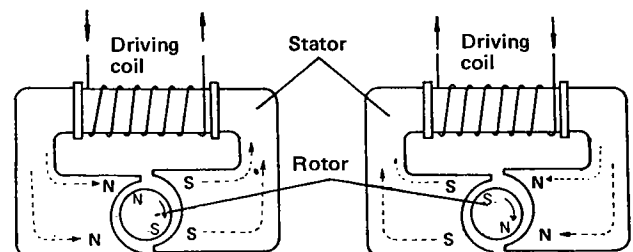
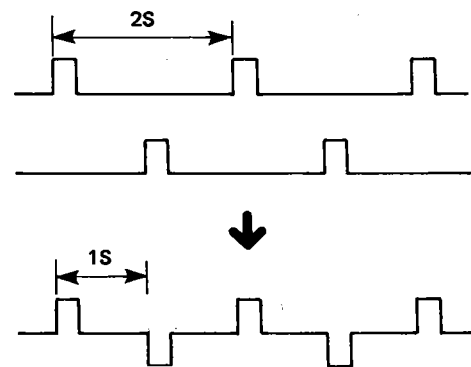

2. Structure of movement

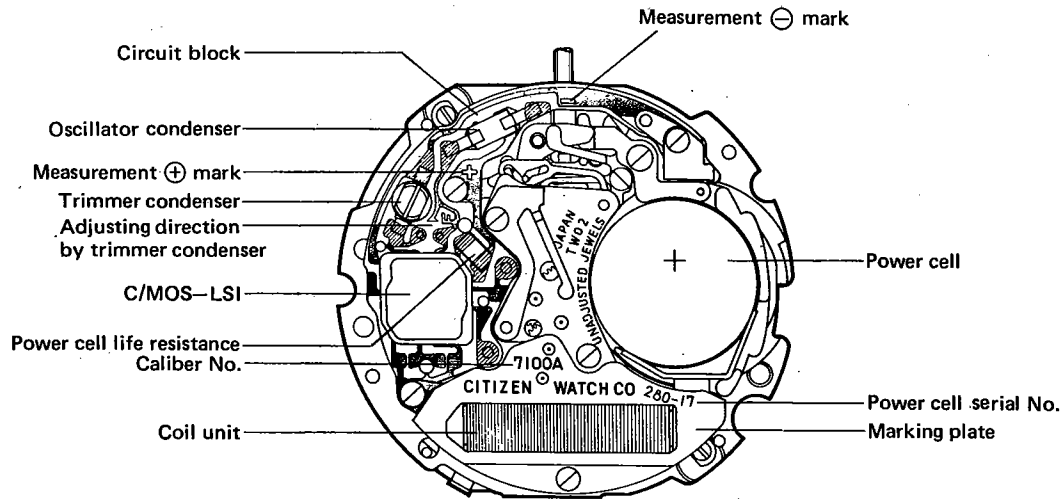

The movement comprises the circuit block, coil unit, power cell, train wheels surrounded by these parts, and the mechanical part consisting mainly of a step motor. Both the ⊕ and ⊖ marks are provided to show the adjusting direction of the trimmer condenser to facilitate an easier troubleshooting and adjustment.

3. Start-stop and hand setting mechanism

When the crown is pulled out two steps, the resetting lever hits the reset terminal. And the division output of the circuit is held to secure a power-conservation state. Thus, the second hand stops just on the second gradations at that moment. (In this case, both the second hand stopping device and the quartz crystal are operating as always.)

At the same time, the fourth wheel and pinion is stopped and the train wheels are fixed for their movement by means of the hand turning torque. The hand starts again in one second after the crown pushed in.

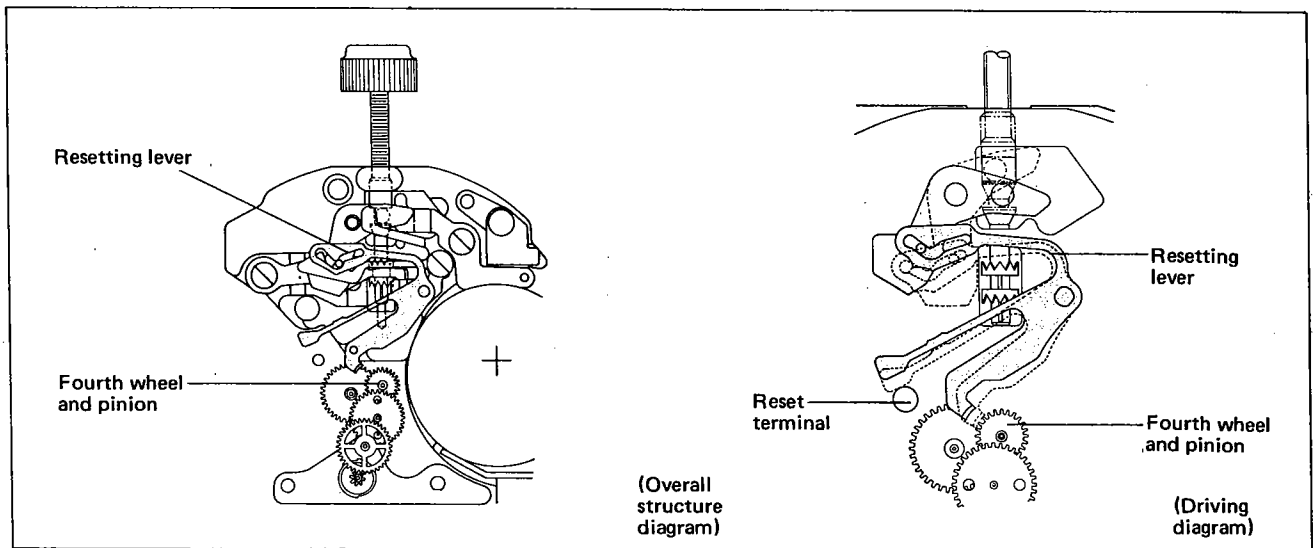

6. DISASSEMBLY/ASSEMBLY OF MOVEMENT WITH LUBRICATION

Disassembling procedure: ① → ④① (shown in diagram)
 Assembling procedure: ④① → ①
 The number of the screw coming with the parts is shown in such a symbol as (T 1).
 The kind of oil and the area to be lubricated are indicated by the following symbols. ⓐ◁ : Synt-A-Lube oil ◉▶ : Synt-V-Lube Oil
 ○◉◉ : Citizen watch oil CH-1

1. Disassembly/assembly of dial side

Use the movement holder exclusive for Cal. No. 71-series watches.

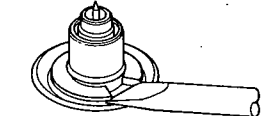
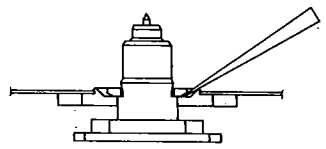
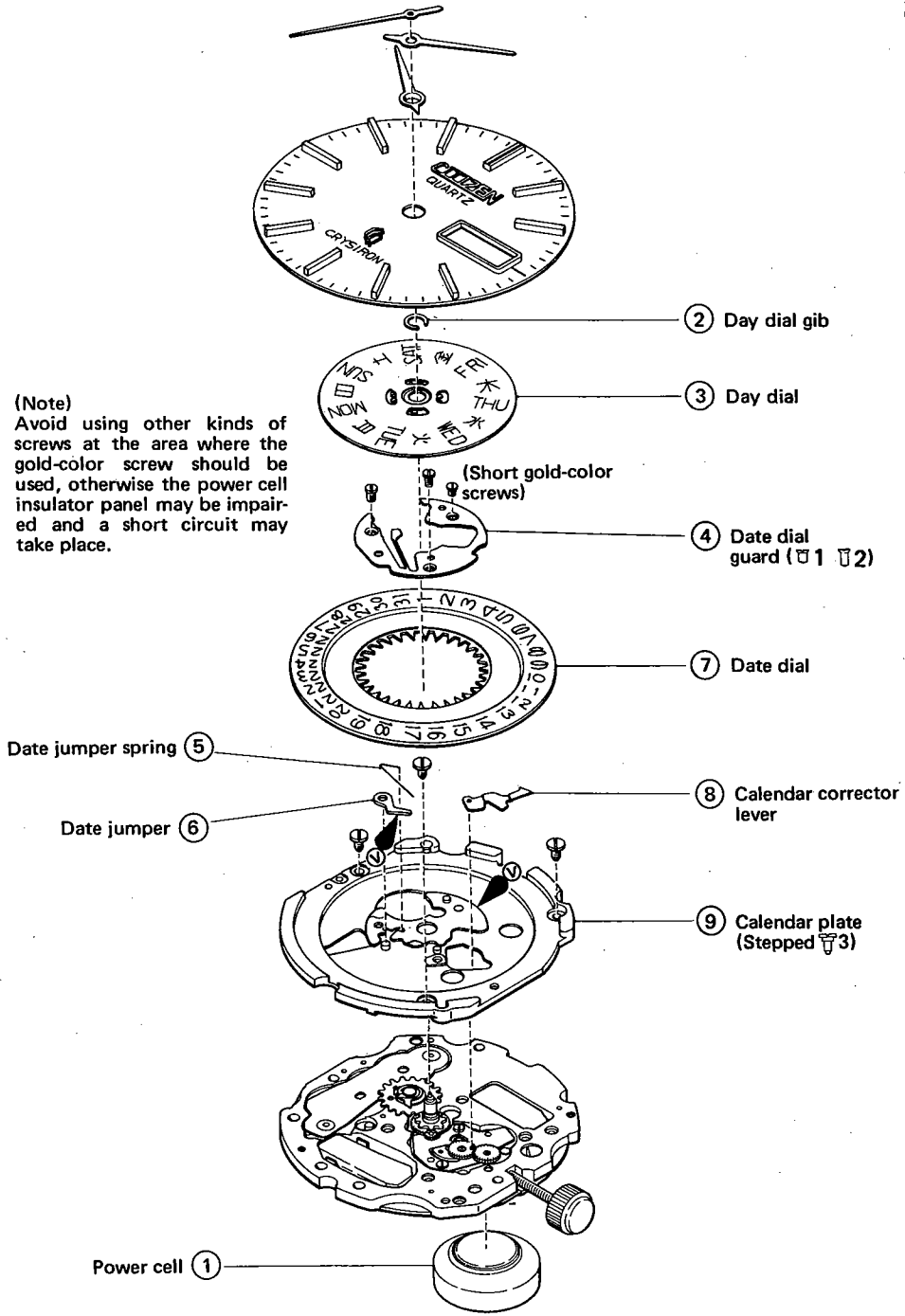

To remove the day dial gib insert a driver into a groove as shown in the diagram and pry the rest open.

⑨' Assembly of zero resetting lever (7140* only):
 The zero resetting lever is assembled on the back of the calendar plate, and not required to be removed usually. When assembling, set the lever accurately to the prescribed position on the calendar plate.

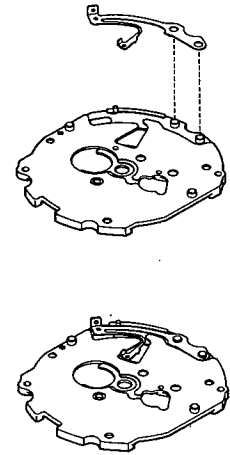

Confirm that the lever is settled correctly onto the calendar plate.

2. Disassembly/assembly of dial side mechanism

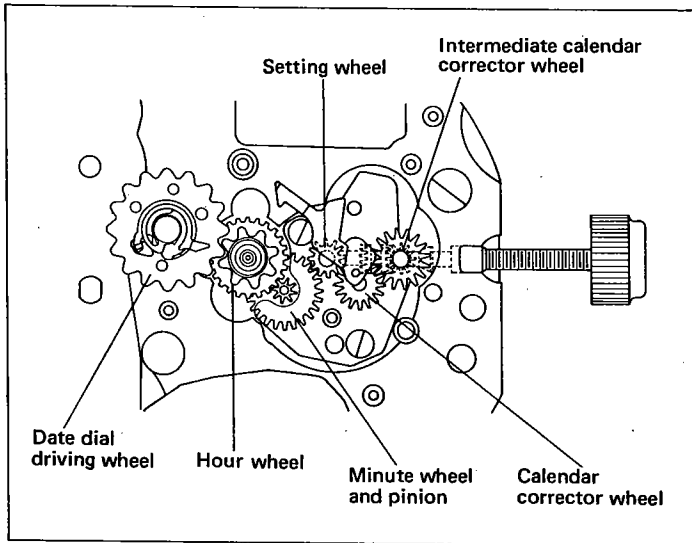

Apply CH-1 oil to the slip-area between wheel and pinion of the cannon pinion with driving wheel.

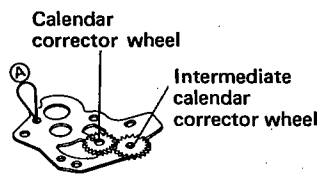
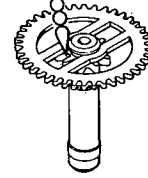

(Note)

Lubricate the pivot with A-Lube oil in case the minute wheel guard is attached with a pivot.

The plain watches (7120*, 7130*) have the minute wheel guard attached with no calendar corrector wheel nor intermediate calendar corrector wheel.

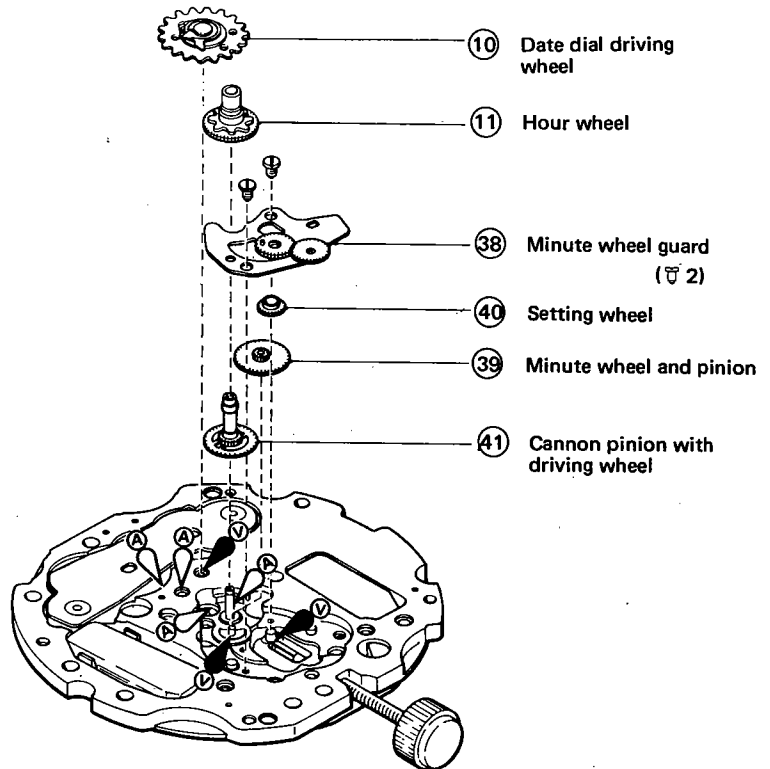

3. Disassembly/assembly of electronic circuit side

The parts of the electronic circuit side are not required to be washed, but the dust or stains stuck at the contacts must be cleared off since they may impair the circuit function.

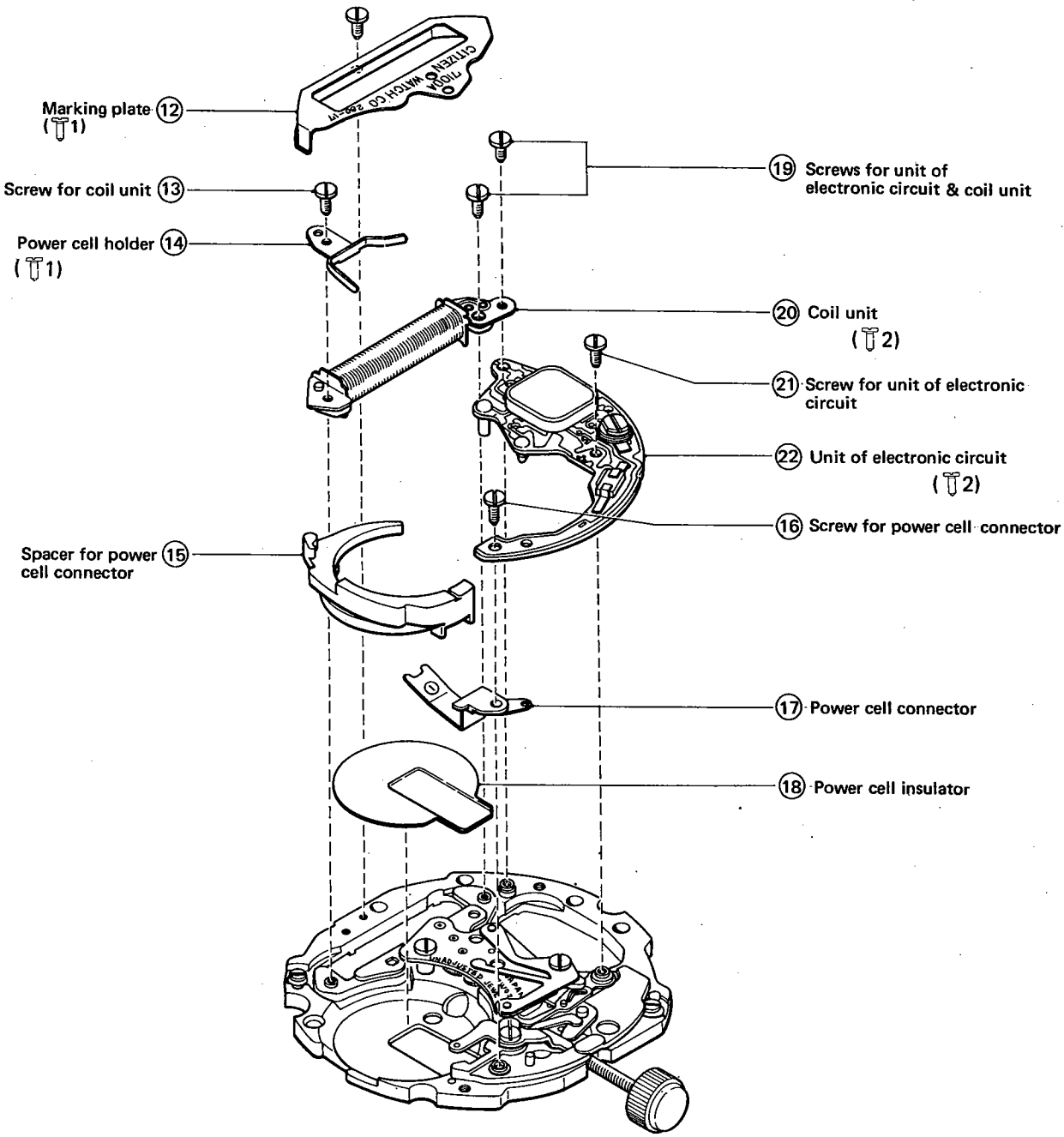

4. Disassembly/assembly of train wheels side

(Note)
Confirm the friction spring for fourth wheel guard is holding the fourth wheel and pinion correctly.

(Note)
The rotor must be handles with a non-magnetic tweezers.

(Note)
The stator is not required to be removed usually. But when removing, insert a driver into the area shown by the dotted line circle in the diagram, and pry it open. In this case, avoid pushing the shield plate.

(Note)
The unlocking lever for setting stem is assembled by sliding its tip under the setting lever. Notice that the screw is stepped.

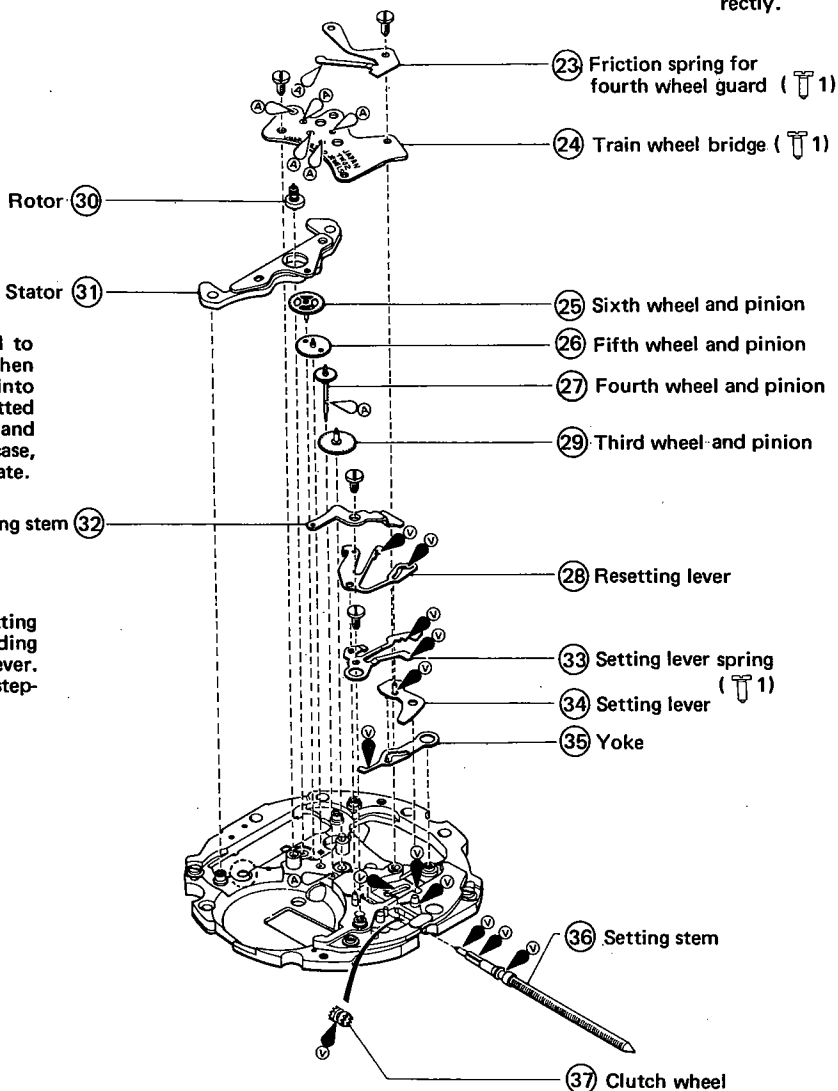

(Note)
The assembling into the pivot must be carried out carefully. Particularly, the sixth and third (with pivot) wheels must be put accurately into the lower pivot making sure no floating
The train wheels of this diagram is for Cal. No. 7100A. The shapes of the wheels differ slightly according to the calibers.

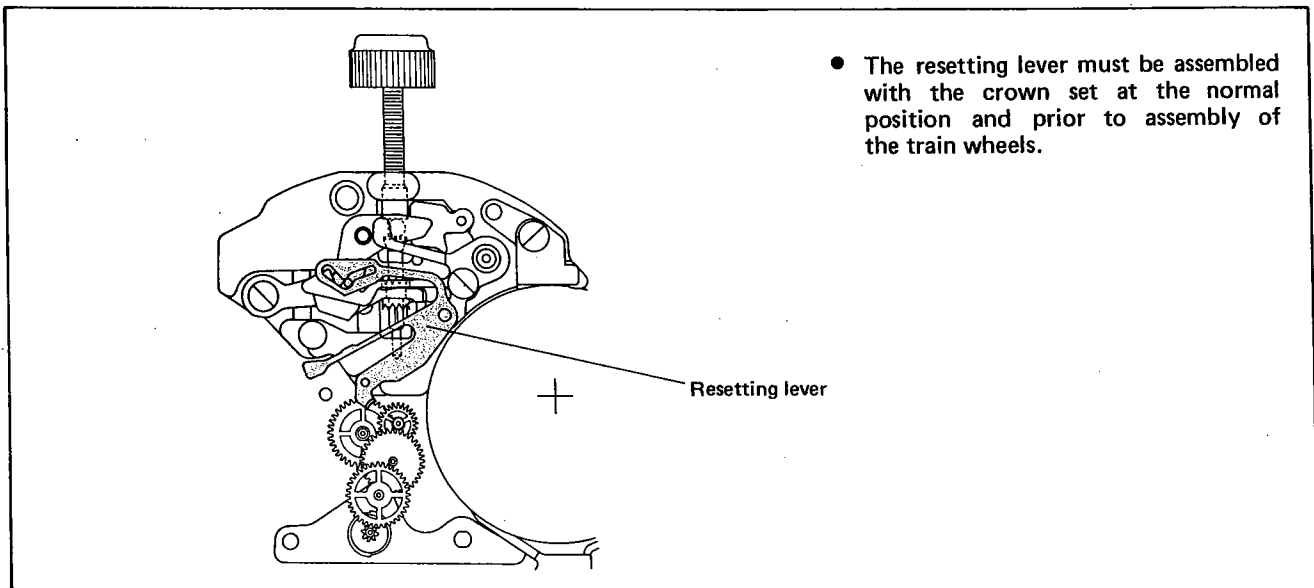

7. TROUBLESHOOTING AND ADJUSTMENT

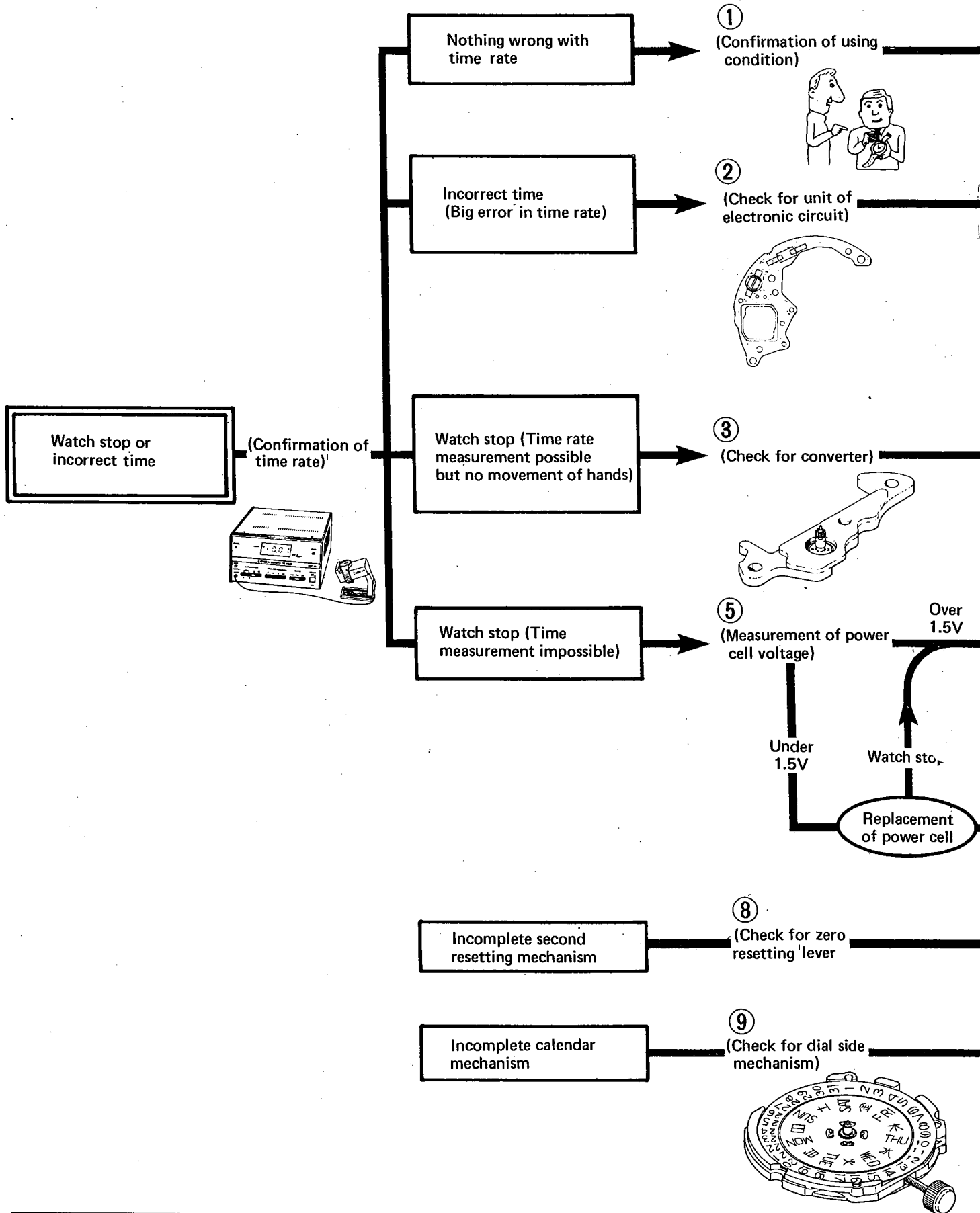

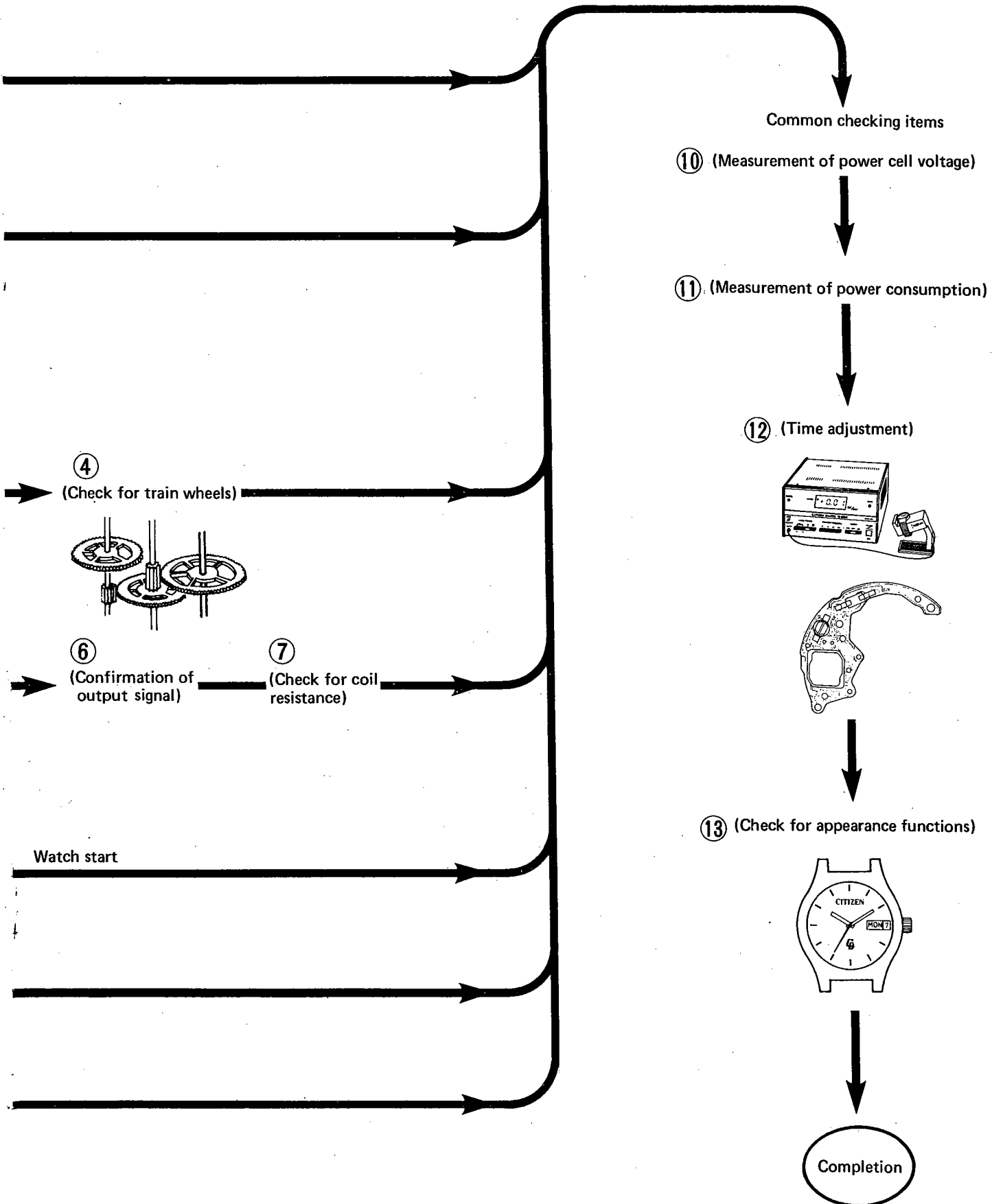

Common checking items

⑩ (Measurement of power cell voltage)

⑪ (Measurement of power consumption)

⑫ (Time adjustment)

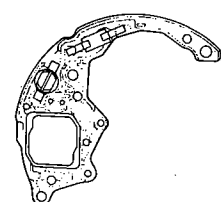
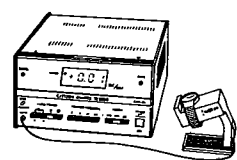

⑬ (Check for appearance functions)

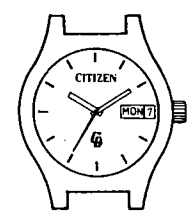

Completion

Nothing wrong with time rate

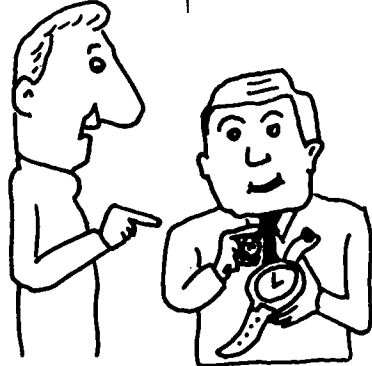
Check item	How to check	Results	Treatment
1 Confirmation of using condition	Confirm how the customer used the watch. (Ex) Wasn't there any mistake in handling the watch?		

Incorrect time (Big error in time rate)

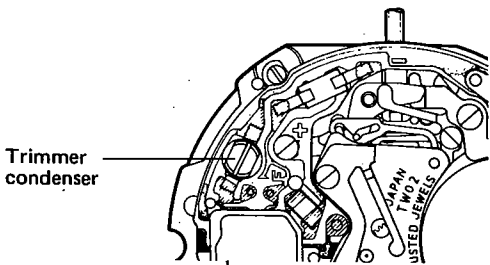
Check item	How to check	Results	Treatment
2 Check for unit of electronic circuit	<p>The cause for a big error in the time rate may lie in the fact that there is a big error in the frequency of the quartz crystal oscillator. Conduct the check for the above on the basis of the following check points.</p> <ol style="list-style-type: none"> 1. Make sure the trimmer condenser can adjust the time or not. 2. When the time adjustment is impossible by the trimmer condenser, the cause of the trouble may be in the faulty quartz crystal oscillator. 3. The trimmer condenser can well adjust the time. 		<p>→ Replacement of unit of electronic circuit</p> <p>→ Common check items</p>

Watch stop (Time rate measurement possible but no movement of hands)

Check item	How to check	Results	Treatment
<p>3 Check for converter</p>	<p>The converter functions to convert the electrical energy into the mechanical energy. In this respect, conduct the check on the basis of the following check items.</p> <p>1. Check of rotor and related mechanism:</p> <ul style="list-style-type: none"> • Is the rotor's play appropriate? • Isn't there any trouble in the rotor's pinion? • Isn't there any dusts or iron filings attached on the upper dowel of the rotor? <p>Check points In case the watch stops but the time rate measurement is possible, there will be no trouble in the electrical factors. The cause of the trouble may lie in the mechanical factors. Therefore, conduct a thorough check for the converter and the train wheels and their related mechanism.</p>		
<p>4 Check for train wheels mechanism</p>	<p>1. The play must be appropriate for each of the sixth wheel, fifth wheel, fourth wheel, third wheel and cannon pinion with driving wheel. Also make sure there is no dusts or alien objects stuck between each pinion and the wheel teeth.</p> <p>2. Make sure that there is no crack or inclination in each hole jewel.</p> <p>3. Check the lubrication condition at each oiling area (oil overflow, lack of oil, stains by oil, etc.).</p> <div data-bbox="483 1297 977 1711" data-label="Diagram"> </div>		

Watch stop (Time measurement impossible)

- 5 Measurement of power cell voltage

Power cell voltage: Over 1.5V

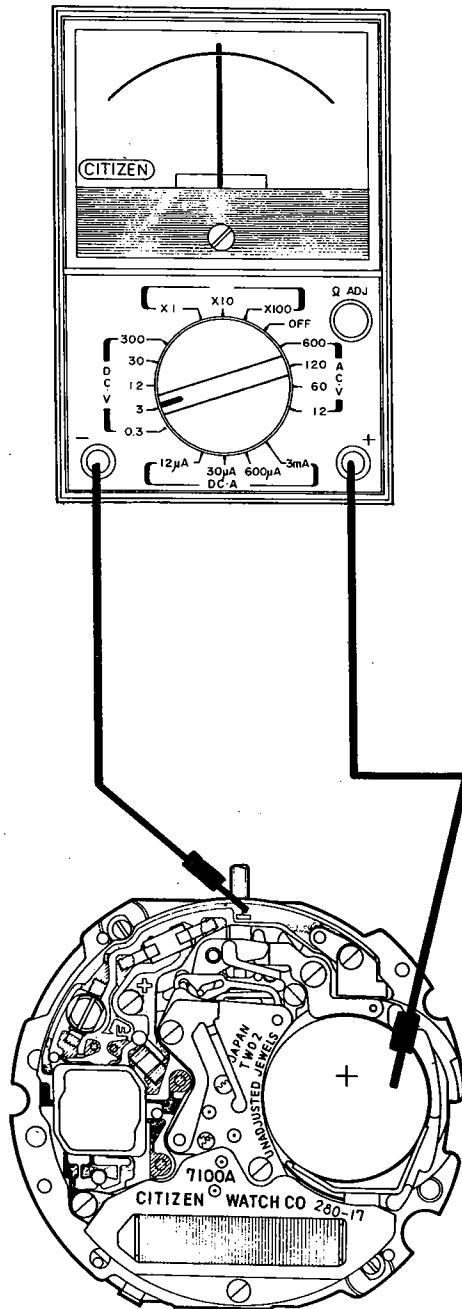

Result and Treatment

Over 1.5V

- Watch stop
→ ⑥ Confirmation of output signal
- Watch start
→ ⑪ Measurement of power consumption

Under 1.5V

Replace power cell:

- Watch stop
→ ⑥ Confirmation of output signal
- Watch start
→ ⑪ Measurement of power consumption

Note

If the watch has been used more than two years, replace the power cell with new one even if it shows more than 1.5V output power.

How to Put in Power Cell

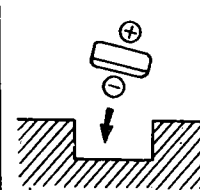

The power cell must be put in with the ⊕ side up.

6 Confirmation
of output
signal

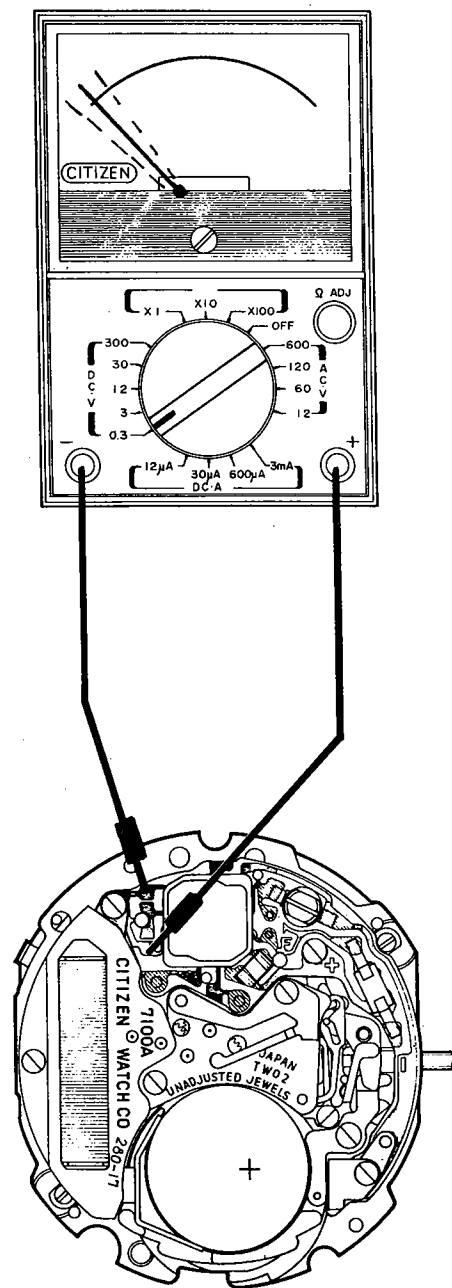

Result and Treatment

- *The crown must be set at the normal position.
- *If the indicator goes and comes back beyond "0V" at every second, it is judged that the output signals are being emitted.

Output signal recognized

- ⑦ Check for coil resistance

No output signal

- Replacement of unit of electronic circuit

Note

You can apply the test-lead to either of plus (+) and minus (-) terminals.

7 Check for coil resistance

Coil resistance value:
 2.2k Ω ~ 3.2k Ω (excluding 7120*, 7130*)
 3.6k Ω ~ 4.3k Ω (7120*, 7130*)

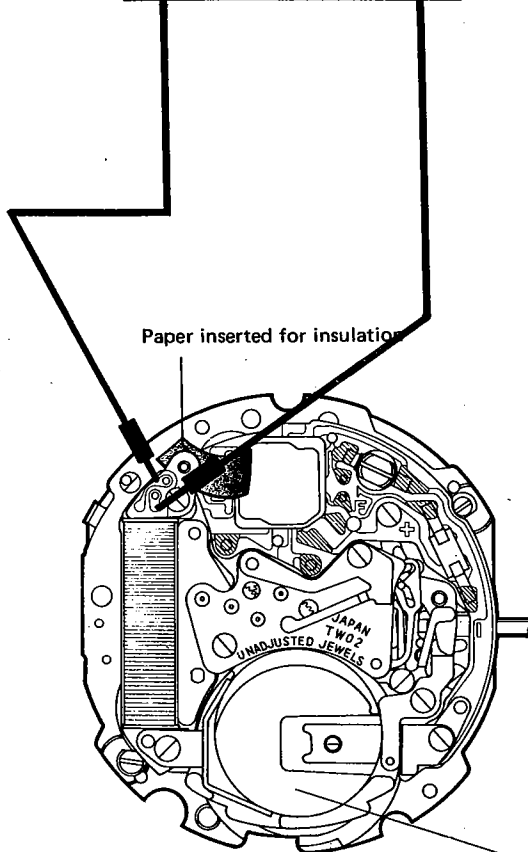
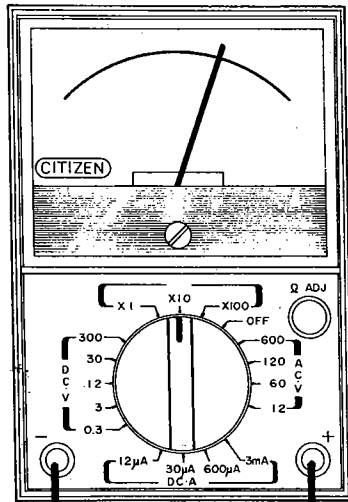

Result and Treatment

The coil resistance value:

2.2k Ω ~ 3.2k Ω
 (excluding 7120* & 7130*)
 3.6k Ω ~ 4.3k Ω
 (7120* & 7130*)

→ Common check items

The value outside the range:

2.2k Ω ~ 3.2k Ω
 (excluding 7120* & 7130*)
 3.6k Ω ~ 4.3k Ω
 (7120* & 7130*)

→ Replacement of coil unit

Note

- 1) Before measurement of the coil resistance value, never fail to conduct "0 Ω " adjustment by short-circuiting the both terminals of the tester.
- 2) Measure the coil resistance securing an insulation between the coil unit and the electronic circuit unit with insertion of paper or the like between them, after removing the screws for the marking plate, power cell and electronic circuit unit and untightening the screw for the coil unit respectively.
- 3) You can apply the test-lead either to plus (+) or minus (-) coil terminal.

Incomplete second resetting mechanism

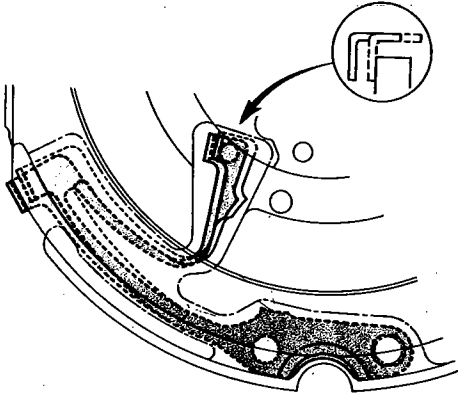
Check item	How to check	Results	Treatment
<p>8 Check for zero resetting lever</p>	 <p>1. Check whether the zero resetting lever operates properly.</p> <p>2. Check whether the push-button has a smooth operation.</p> <p>If the trouble cannot be detected through the above check, it is conceivable that some fault exists in the electronic circuit unit. So the circuit unit must be replaced.</p>	<p>Lever out of position</p> <p>Deformation of lever</p> <p>Faulty calendar plate</p> <p>Dust stuck</p> <p>Deformation or breakage of push-buttons</p>	<p>Reassembly</p> <p>Replacement of lever</p> <p>Replacement of calendar plate</p> <p>Removal</p> <p>Replacement of push-buttons</p>

Incomplete calendar mechanism

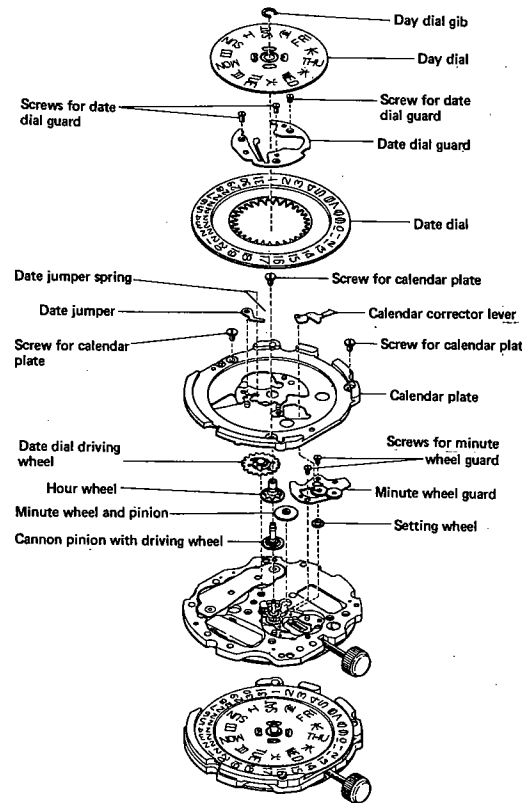
Check item	How to check	Results	Treatment
<p>9 Check for dial side mechanism</p>	<p>Check calendar mechanism by the following procedure.</p> <p>1. Make sure day and date change correctly by turning hands.</p> <p>A. Date does not change:</p> <ul style="list-style-type: none"> • Isn't the date jumper correctly fixed? • Isn't the finger of date dial driving wheel deformed? • Isn't there any creak in the date dial driving wheel? <p>B. Day does not change:</p> <ul style="list-style-type: none"> • Isn't the day dial driving wheel finger deformed? • Isn't there any creak in day dial driving wheel? <p>2. Check quick setting of day and date by pulling out the crown to the first click stop position.</p> <p>In case neither day nor date can be quick-set, or either day or date can be quick-set:</p> <ul style="list-style-type: none"> • Isn't the calendar corrector lever slipped out? • Isn't too much amount of oil supplied to the calendar corrector wheel? • Check whether the date dial's rubbing surface of the calendar plate receives an ample amount of oil. 	<p>Date jumper slipped out →</p> <p>Finger deformed →</p> <p>Finger deformed →</p> <p>Calendar corrector lever slipped out →</p> <p>Too much oil supplied →</p>	<p>Fix it again.</p> <p>Replace date dial driving wheel.</p> <p>Replace date dial driving wheel.</p> <p>Fix it again.</p> <p>Wash it out.</p>

Common checking items

- 10 Measurement of power cell voltage

Power cell voltage: Over 1.5V

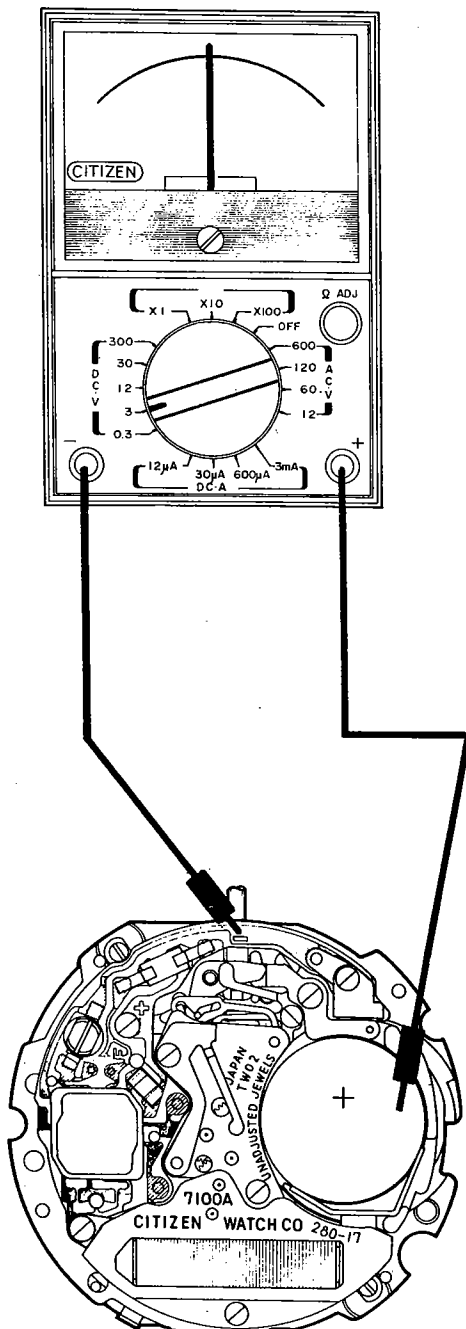

Result and Treatment

Over 1.5V

- Watch stop
→ ⑥ Confirmation of output signal
- Watch start
→ ① Measurement of power consumption

Under 1.5V

Replace power cell:

- Watch stop
→ ⑥ Confirmation of output signal
- Watch start
→ ① Measurement of power consumption

Note

If the watch has been used more than two years, replace the power cell with new one even if it shows more than 1.5V output power.

How to Put in Power Cell

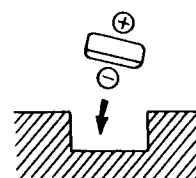

The power cell must be put in to with the ⊕ side up.

11 Measurement of power consumption

Power consumption: Under $4.0\mu\text{A}$

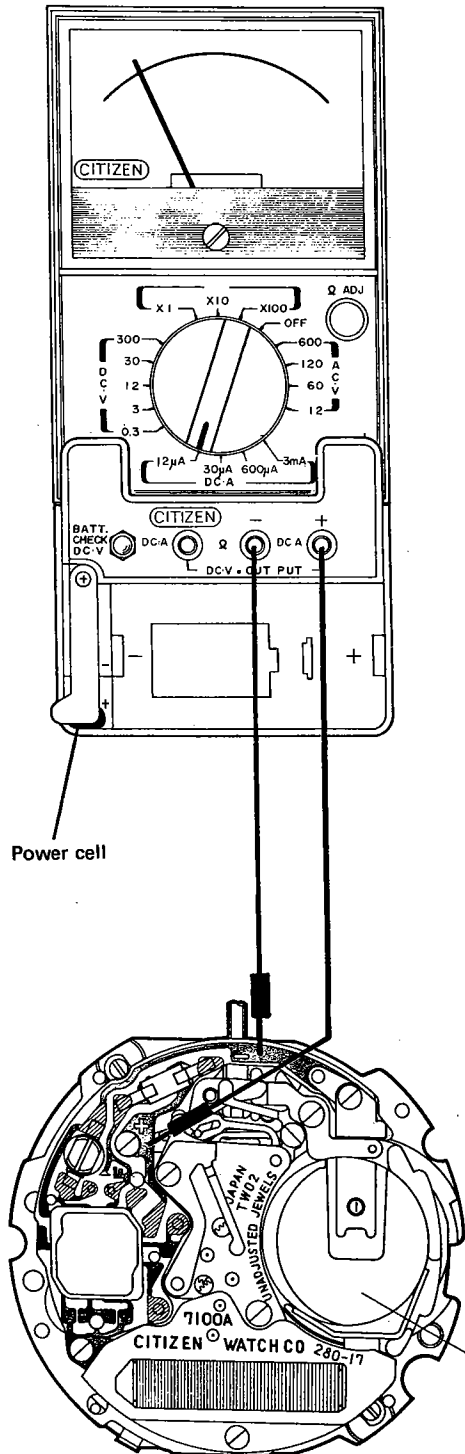

Result and Treatment

1) Power consumption value under normal condition:

Under $4.0\mu\text{A}$

→ ② Time adjustment

Over $4.0\mu\text{A}$

→ 2) Measurement of power consumption under power-conservation state.

2) Measurement of power consumption under the power-conservation state. (With crown pulled out by time setting position).

Under $2.0\mu\text{A}$

→ ③ Check for converter

Over $2.0\mu\text{A}$

→ Replacement of unit of electronic circuit

Note

Never fail to install the power cell of more than 1.5V into the power cell holder of the adaptor.

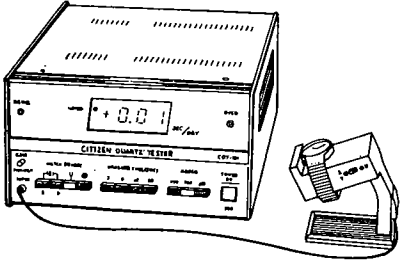
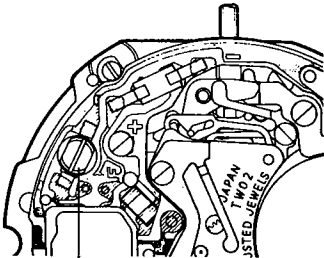
Check item	How to check	Results	Treatment
12 Time adjustment	<p data-bbox="451 283 966 336">By use of the Citizen Quartz-timer, measure the time rate.</p>  <p data-bbox="456 730 971 762">Adjust the time in the following procedure.</p> <ul data-bbox="456 785 971 865" style="list-style-type: none">• As shown in the diagram below, the time can be adjusted by turning right and left the screw of the trimmer condenser.  <p data-bbox="477 1268 659 1293">Trimmer condenser</p>		

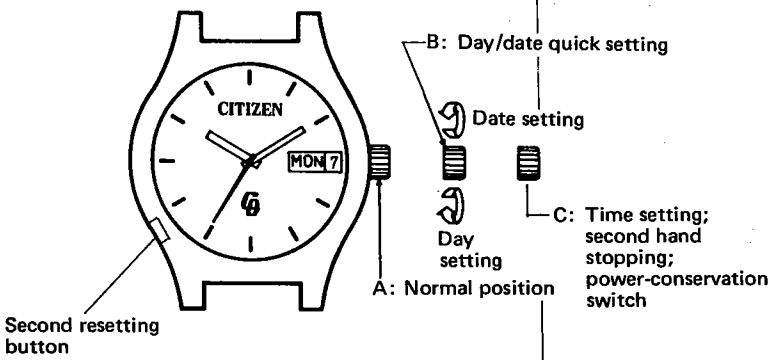
Check item	How to check	Results	Treatment
<p>13 Check for appearance functions</p>	<p>Check the appearance functions as follows.</p> <ul style="list-style-type: none"> • Check whether a smooth hand turning is possible. • Set the time with the crown pulled out two steps (C-position), and confirm that a smooth and proper operation is possible for the second hand stop and the power-conservation switch. • Confirm that a correct quick correction is possible for the date and day with the crown pulled out one step (B-position). <p>Then, check whether the second resetting device operates properly.</p> <p>(Correction of gain) Keep pushing the second correction button for the time equivalent to the seconds gained.</p> <p>(Correction of loss) Push and release pushing the second resetting button in the same pushing times as the seconds lost.</p>  <p>The diagram shows a side view of a Citizen watch. The crown is on the right side of the case. It has three distinct positions: A (Normal position), B (Day/date quick setting), and C (Time setting; second hand stopping; power-conservation switch). The second resetting button is located on the left side of the case, near the 9 o'clock position. The watch face shows the brand name 'CITIZEN', the day 'MON', and the date '7'.</p>		

CITIZEN WATCH CO., LTD.
Tokyo, Japan