

***TECHNICAL  
INFORMATION***

---

---

**CITIZEN QUARTZ**

**Cal. No. 6720**

---



 **CITIZEN**

## §1. OUTLINE

This is an analog multi-hand watch having the world-time function, which can indicate the home time (basic watch) and the time and calendar in 23 cities (districts) in the world by simply pushing a button.

## §2. SPECIFICATIONS

Caliber No.	6720-00A		
Type	Analog quartz watch (multi-hand)		
Module size (mm)	ø32.5 x 4.3 t		
Accuracy	±20 sec./month (at normal temp.)		
Oscillation	32.768 Hz		
Converter	Bipolar step motor (4 units)		
Integrated circuit	C/MOS-LSI (One CPU and one for driving motor)		
Effective temperature range	-10 °C ~ +60 °C (14 °F ~ 140 °F)		
Adjustment of time rate	Trimmer condenser		
Measurement of time rate	10 seconds		
Additional functions	<ul style="list-style-type: none"> <li>• Hand-type calendar Year (with recognition of leap year), month, and date</li> <li>• Hand-type world time City selection [Indication of 23 cities (district)/24 zones] World time (24-hour system)</li> <li>• Changeover of day-light saving time</li> <li>• Warning for incompleteness of initial setting</li> <li>• Second hand stopping device</li> </ul>		
Battery	Part No.	280-74	
	Battery code	SR936W	
	Size (mm)	ø9.4 x 3.6 t	
	Nominal voltage	1.55 V	Nominal capacity 75 mAH
	Lifetime	Approx. 3 years	
Current consumption	3.1 µA		
Coil resistance	Coil unit	2.1 kΩ ~ 2.5 kΩ	
	Date coil unit, World time coil unit City oil unit	2.0 kΩ ~ 2.4 kΩ	

### §3. OPERATING METHOD

#### A. Before Using this Watch

Before using this watch, be sure to confirm that it is so set that all the functions can be used (it is at the initial position) according to the following procedure..... Initial monitor.

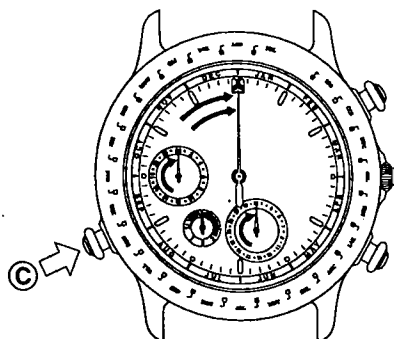

#### Keep the crown at the normal position.

If the (C) button is pressed for about 3 seconds, the hands move quickly to the following positions to confirm if they are set to the initial positions.

World time watch:

City selecting hand: 12 o'clock (top) position

World time hand: 24 o'clock (top) position

Calendar:

Date and month hands: Dec. 31th

Year hand: 12 o'clock (top) position

If any hand is not set to the above position when the initial monitoring is performed, set it according to procedures 1 to 3 in 8.

Countermeasures against troubles.

After the initial position setting is confirmed by the initial monitoring, press any one of the a, b and c buttons, the watch is returned to the present world time and calendar.

Even if none of them is pressed, the watch is returned automatically to the present world time and calendar about 20 seconds later.

#### B. How to Set Initial Positions

##### 1 Perform the All Reset Operation.

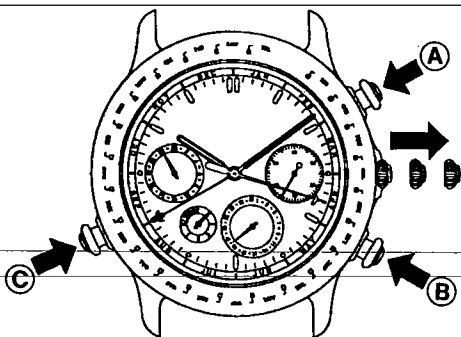

#### Pull the crown to the second click.

- 1) Press the (A), (B), and (C) buttons at the same time.
- 2) About 1 second after the (A), (B), and (C) buttons are released, the world time hand, city selecting hand, and date hand (month hand, year hand) are rotated in order.

##### 2 Set the Hands to the Initial Positions.

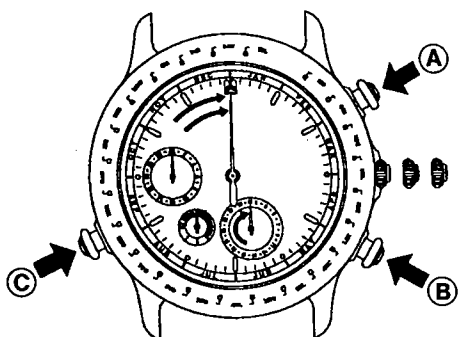

#### Keep the crown at the second click.

\* If any one of the (A), (B), and (C) buttons is pressed and held, the corresponding hand moves quickly.

- 1) Press the (A) button to set the city selecting hand to the 12 o'clock (top) position.
- 2) Press the (B) button to set the year hand to the 12 o'clock (top) position, then set the month and date hands to Dec. 28th (top) position. The year and month hands are interlocked with the date hand.
- 3) Press the (C) button to set the world time hand to the 24 hours (top) position.

### 3 Set the Watch to the Present Time/Calendar.

See 2. HOW TO SET TIME and 3. HOW TO SET CALENDAR above explained in this manual.

\* For the name of each hand, etc., see 4. NAME OF EACH PART on page 7 of this manual.

After the power cell is replaced, set watch according to the following procedure. If it is not set correctly, the world time watch (city selecting hand/world time watch) and the calendar hands do not work normally.

★ The city selecting hand moves quickly in reverse.

- This indicates that the alarm for incompleteness of initial setting is working. In this case, set the watch according to following procedure 1 to 3.

## C. Precautions for Using

- For the normal use, keep the crown pressed in (at the normal position). If the crown is kept pulled out, the power cell runs out more quickly than in the normal position. Keep the crown at the normal position while this watch is not used.
- Since the calendar of this watch does not need to be adjusted at each month end and in each leap year, you can use it without adjusting it as long as it is used normally.

## 1. How to Read the Watch

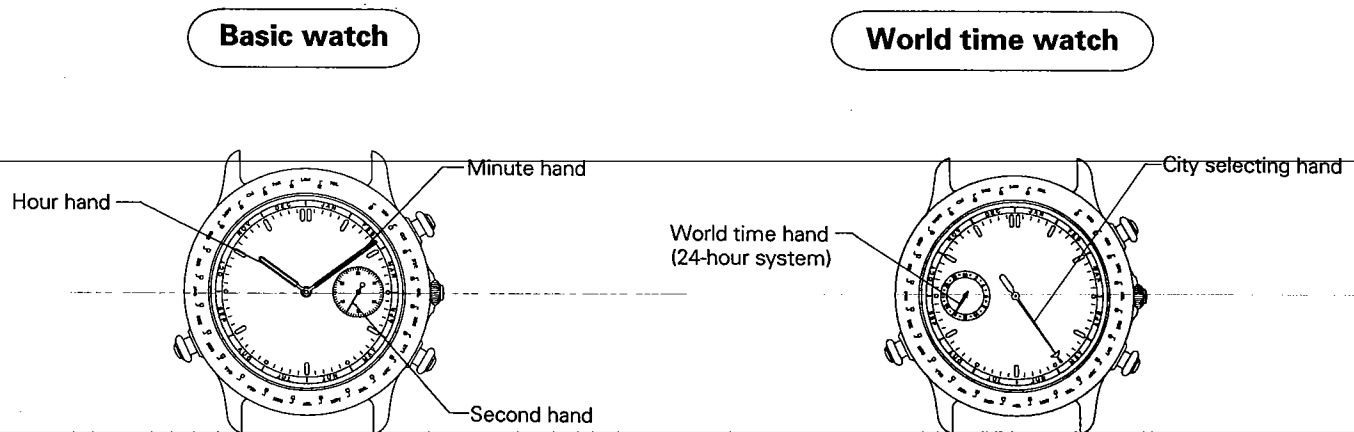

- Set the city selecting hand to the city (district) for which you wish to set the watch, and the world time hand indicates the present time of that city (district).
- Since the world time hand is an hour hand which moves every 15 minutes, it may be deviated a little from the correct position. Accordingly, read the "minutes" of the world time watch from the basic watch.

## Calendar

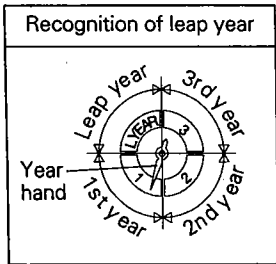

LY: Leap year

This hand indicates a leap year and how many years have passed after it. It takes four years for this hand to rotate by one turn.

### Example:

If the year hand is at the 1 position as shown above, this year is the first year after the last leap year.

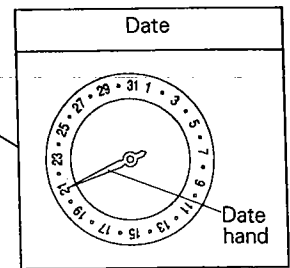
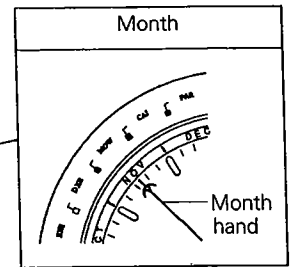

## 2. How to Set Time

### a. HOW TO SET THE BASIC WATCH

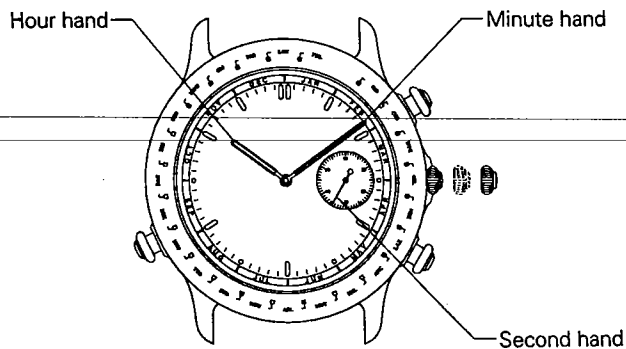

**Pull the crown to the second click so that the second hand will stop at 0 second.**

- Rotate the crown to right or left to set the time. After the time is set, press the crown to the normal position to a time signal.

\* The calendar cannot be changed by setting the time.

## b. HOW TO SET THE WORLD TIME

Before using the world time watch, set its time an (including cities) to the time of basic watch for convenience.

### 1 Set the City Selecting Hand.

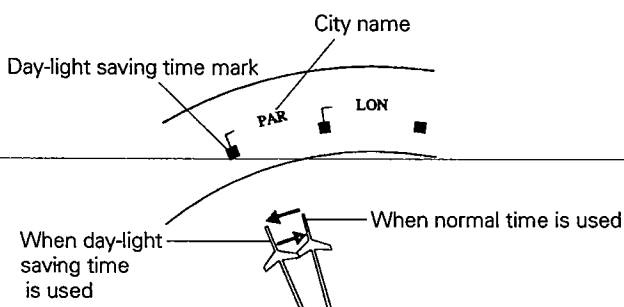
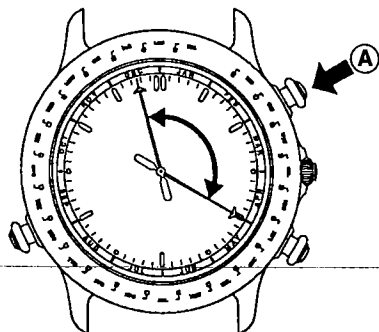

### Pull the crown to the first click

Press the (A) button to set the city selecting hand to the city (district) of the present time indicated by the base watch.

- When the basic watch is set to the normal time, set the city selecting hand to the city name, and when the former is set to the day-light saving time, set the later to the day-light saving time mark ( ).
- Every time the (A) button is pressed, the city selecting hand is move by 1/2 city, and if the former is pressed and held, the latter is moved quickly.

### 2 Set the World Time Watch

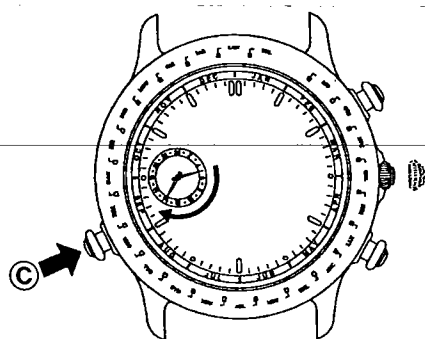

### Keep the crown pulled to the first click.

Press the (C) button to set the world time watch to the time indicated by the basic watch.

- Every time the (C) button is pressed, the world time hand is move by 15 minutes, and if the former is pressed and held, the latter is moved quickly.
- The world time hand moves by 15 minutes. It can be set more quickly if it is set when the basic watch is indicating 00, 15, 30, or 45 minutes.
- Since the world time watch operates by 24-hour system, confirm am and pm when setting it.

The world time watch stops when the crown is pulled to the first or second click, and the former starts when the latter is returned to the normal position.

### 3. How to Set Calendar

The calendar is interlocked with the world time watch, but not with the basic watch. The calendar changes when the world time indicates 00:00 am.

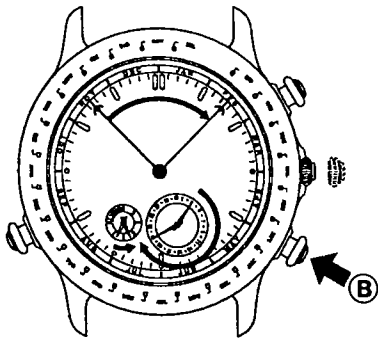

#### **Pull the crown to the first click.**

Press the Ⓑ button to set the calendar to today of this year. The day hand, month hand, and year hand are interlocked with one another. Confirm how many years have passed by this year since the last leap year in advance. (see the leap years list shown below.) Set the year hand, month hand, and date hand in order.

\* Every time the b button is pressed, the date hand is advanced by one day, and if the former is pressed and held, the latter is advance quickly.

This watch does not need to be adjusted at each month end and in each leap year.

#### **Example:**

- No need of adjustment at month end:  
The date is automatically changed from Nov. 30 to Dec. 01.
- No need of adjustment in leap year:  
The date is automatically changed from Feb. 29 to Mar 01 leap year and from Feb. 28 to Mar 01 in normal year.

- \* Return the crown to the normal position after the calendar is changed. If it is kept at the first click, the calendar does not change.
- \* The month hand may deviates at the borderline between the end of each month and the beginning of the next month. In this case, judge the correct month by the position of the date hand.

---

### 4. How to use World Time Watch (How to Read the Present Time in Various Places in the World)

---

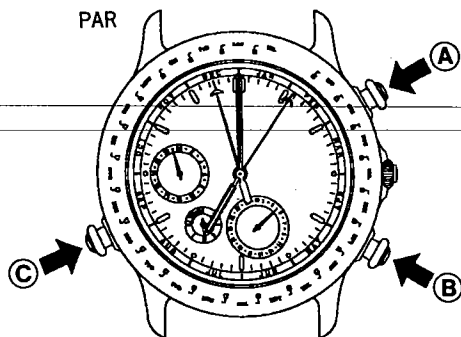

#### **Keep the crown at the normal position.**

If the city selecting hand is set to a city (district) by pressing the Ⓐ or Ⓑ button, the world time watch indicates the present time of that city (district). At this time, the calendar also indicates the date of that city. The city selecting hand can be moved with the Ⓐ and Ⓑ buttons as follows.

- Ⓐ: Turning in reverse
- Ⓑ: Turning forward

Every time the Ⓐ or Ⓑ button is pressed, the city selecting hand moves by one city (district), and if either of them is pressed and held, the latter moves quickly.

#### **Example:**

Present time (Tokyo): 7:00 AM  
Time in Paris: 11:00 PM

---

## <How to set day-light saving time>

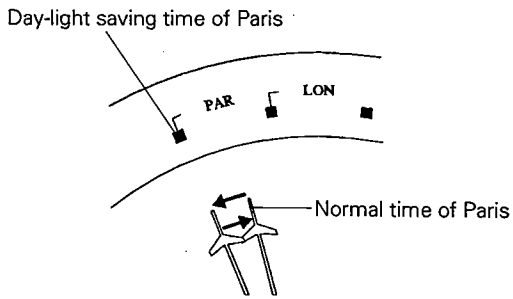

If day-light saving time is used in the city (district), the time of which you want to know, press the © button to set the city selecting hand to the day-light saving time memory (■). At this time, the world time watch is advanced by one hour to indicated the day-light saving time. If the © button is pressed again, the world time watch is returned to the normal time.

\* Mark of ■ indicates the cities (districts) where the day-light saving time is used, and that of □ indicates the cities where the day-light saving time is not used (as of 1989).

## 5. Name of Each Part and List of Operations

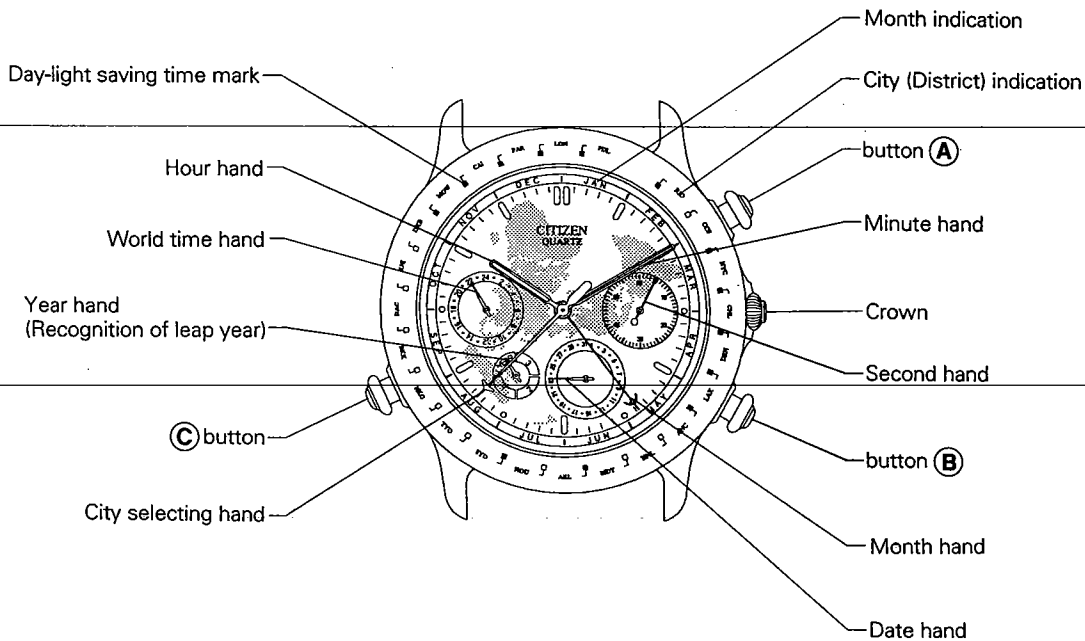

Crown \ Button	Pressing (A) button	Pressing (B) button	Pressing (C) button	Turning crown
Normal position	Selection of city (City selecting hand moves in reverse)	Selection of city (City selecting hand moves forward)	Change over of day-light saving time (Note)	
1st	Setting of world time watch (City selecting hand)	Setting of calendar	Setting of world time watch (World time hand)	
2nd				Setting of base watch

### Note:

- If the © button is pressed while the day-light saving time is indicated, the watch is returned to the normal time.
- If the © button is press and held for about 3 seconds with the crown at the normal position, the initial monitor can be performed.



# LIST OF TIME DIFFERENCES FROM GREENWICH MEAN TIME

UTC (Universal Time Coordinated)

Time difference	Main city	City Code	Country	Day-light saving time	
	Greenwich Mean Time	UTC (G.N.T)			Application period
±0	LONDON	LON	England	○	
+1	PARIS	PAR	France	○	
+2	CAIRO	CAI	Egypt	○	
+3	MOSCOW	MOW	USSR	○	
+4	DUBAI	DXB	United Arabu Emirates	X	
+5	DARACHI	KHI	Pakistan	X	
+6	DHAKA	DAC	Bangladesh	X	
+7	BANGKOK	BKK	Thailand	X	
+8	HONGKONG	HKG	English territory	X	
+9	TOKYO	TYO	Japan	X	
+10	SYDNEY	SYD	Australia (East part)	○	
+11	NOUMEA	NOU	New Caledonia	X	
+12	AUCKLAND	AKL	New Zealand	○	
-11	MIDWAY MDY	USA		X	
-10	HONOLULU	HNL	USA (Hawaii)	X	
-9	ANCHORAGE ANC	ANC	USA (Alaska)	○	
-8	LOS ANGELES	LAX	USA (Pacific Ocean Coast)	○	
-7	DENVER	DEN	USA (Mountainous area)	○	
-6	CHICAGO	CHI	USA (Midland)	○	
-5	NEW YORK	NYC	USA (East area)	○	
-4	CARACAS	CCS	Venezuela	X	
-3	RIO DE JANEIRO	RIO	Brazil	○	
-2	*	-----			
-1	* AZORES (PONTA DELGADA)	----- PDL	Portuguese territory	○	

The cities (districts) where the day-light saving time is used are marked ○, and those where the day-light saving time is not used are marked X (as of 1989).

The time difference and day-light saving time of each country are subject to change.

## LEAP YEARS LIST

### <How to Read this Table>

"L.Y" represents leap year, and 1, 2, and 3 represent the number of years after each leap year.

Example: 1992 is a leap year, and 1993 is the first year after the leap year.

LY	1988	LY	1992	LY	1996	LY	2000	LY	2004	LY	2008
1	1989	1	1993	1	1997	1	2001	1	2005	1	2009
2	1990	2	1994	2	1998	2	2002	2	2006	2	2010
3	1991	3	1995	3	1999	3	2003	3	2007	3	2011

**TIME DIFFERENCE FROM GREENWICH MEAN TIME (UPTAKE) AND 33 CITIES (DISTRICTS) INDICATED BY THIS WATCH.**

Advance date by one day ← → Turn back date by one day

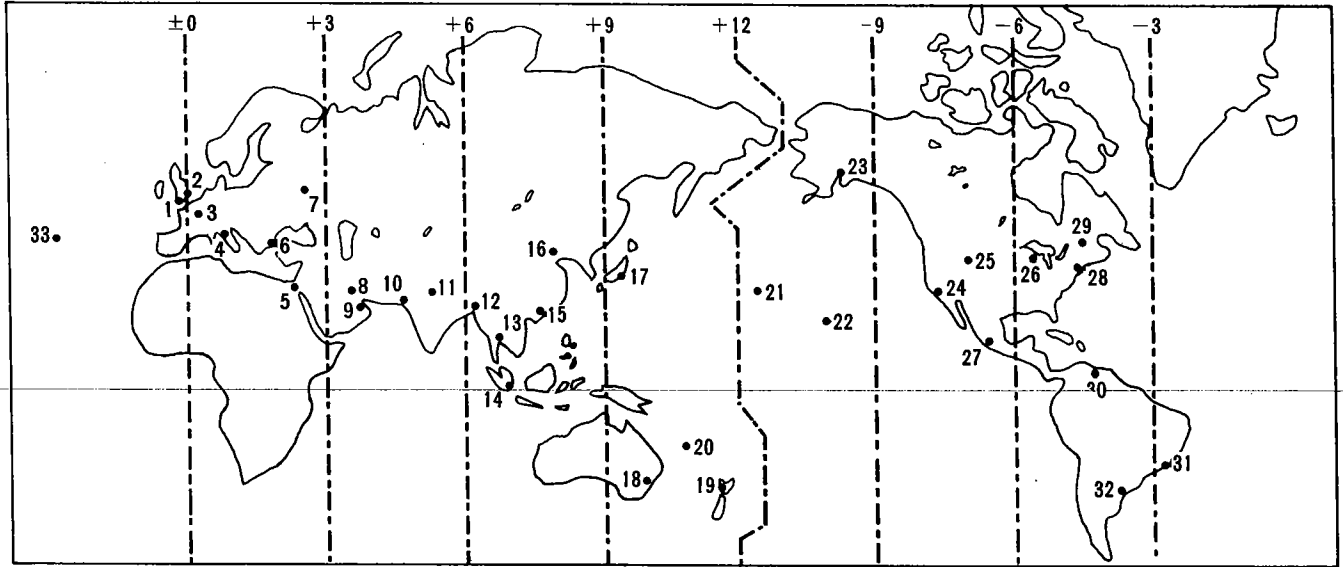

- |                    |                     |                       |                          |
|--------------------|---------------------|-----------------------|--------------------------|
| 1. Greenwich (UTC) | 9. Dubai (DXB)      | 17. Tokyo (TYO)       | 25. Denver (DEN)         |
| 2. London (LON)    | 10. Karachi (KHI)   | 18. Sydney (SYD)      | 26. Chicago (CHI)        |
| 3. Paris (PAR)     | 11. New Delhi (DEL) | 19. Noumea (NOU)      | 27. Mexico City (MEX)    |
| 4. Rome (ROM)      | 12. Dhaka (DAC)     | 20. Auckland (AKL)    | 28. New York (NYC)       |
| 5. Cairo (CAI)     | 13. Bangkok (BKK)   | 21. Midway (MDY)      | 29. Montreal (YUL)       |
| 6. Istanbul (IST)  | 14. Singapore (SIN) | 22. Honolulu (HNL)    | 30. Caracas (CCS)        |
| 7. Moscow (MOW)    | 15. Hong Kong (HKG) | 23. Anchorage (ANC)   | 31. Rio de Janeiro (RIO) |
| 8. Kuwait (KWI)    | 16. Peking (PEK)    | 24. Los Angeles (LAX) | 32. Buenos Aires (BUE)   |
|                    |                     |                       | 33. Azores Islands       |

• **FITTING PROCEDURE OF HANDS**

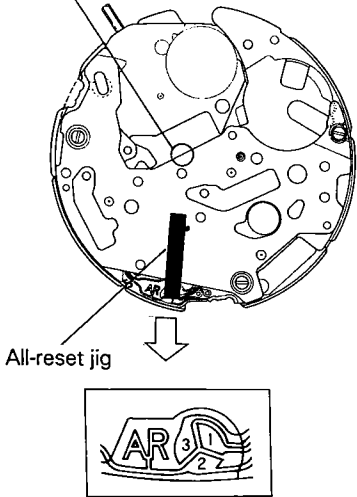
Step	Explanation and precautions
<p>❶ Pull out the crown to the second position</p>	<p>Keep the crown pulled to the second position while fitting the hands to this watch.</p>
<p>❷ Perform all-reset</p>	<p>City select wheel</p>  <p>All-reset jig</p> <p>Keep the three all-reset (AR) patterns (1 ~ 3) on the electronic circuit in contact with an all-reset jig, and electrically connect the train wheel bridge [III] for more than 2 seconds.</p> <p>* If the all-reset has been performed normally, the city select wheel starts 4 ~ 5 seconds after the all-reset condition is reset.</p>
<p>❸ Assemble parts related to hour wheel.</p>	<p>Assemble the hour wheel, month wheel, and dial washer.</p>
<p>❹ Install the dial</p>	
<p>❺ Install the second and world time hands</p>	<p>Install the second hand to 0 second position. Install the world time hand to any position.</p>
<p>❻ Install the month hand and date hand</p>	<p>Install the month hand to 12 o'clock position. Install the date hand to the position of 31st.</p>
<p>❼ Install the year hand</p>	<p>Install the year hand (recognizing leap years) to 12 o'clock position. * The year hand can be installed to any position between two years such as +1 and +2.</p>

Step	Explanation and precautions
<p>⑧ Install the hour and minute hands</p>	<p>Install the hour and minute hands to 12 o'clock position.</p> <p>* The operating time of the calendar is automatically set by setting the world time hand to the 24-hour position by the following initial setting.</p>
<p>⑨ Install the city select hand</p>	<p>Install the city select hand to the center of LON (12 o'clock position).</p> <p>* The city select hand can be set the center of any other city than LON.</p>
<p>⑩ Install the module to the case, then install the case back.</p>	
<p>⑪ Perform all reset</p>	<p>1) Pull the crown to the second position and press the (A), (B), and (C) buttons at the same time.</p> <p>2) Release the (A), (B), and (C) buttons at the same time, and confirm that the world time hand, city select hand, and date hand (Month hand/Year hand) revolve in order.</p>
<p>⑫ Perform initial setting</p>	<p>Referring to the initial setting procedure (Page 3/28) in "Handling method" of this manual, perform initial setting.</p>
<p>⑬ Set the time and calendar</p>	<p>Referring to the setting procedure of time (Page 6/28) in "Handling method" of this manual, set the time and calendar.</p>

## • BATTERY REPLACEMENT PRECEDURE

- \* When replacing the battery, remove one screw and remove the shield plate.  
When replacing the battery, the watch power consumption must be measured with the module in the case.

### 1. Measurement of Current Consumption

1 Pull out the crown to the second position.

2 Set the tester for measuring current consumption, and apply the lead bars of the tester to (+) and (-) of the module.

- \* Keep the lead bars applied until the measurement is finished.

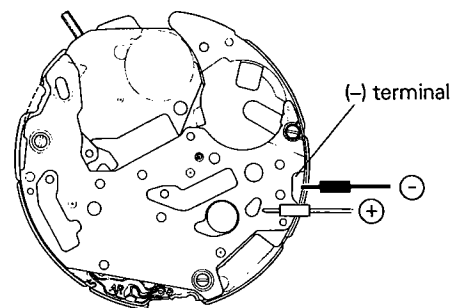

3 Keep the lead bars applied, apply the all-reset jig to the three AR patterns and train wheel bridge [II] for about 2 seconds to perform all-reset.

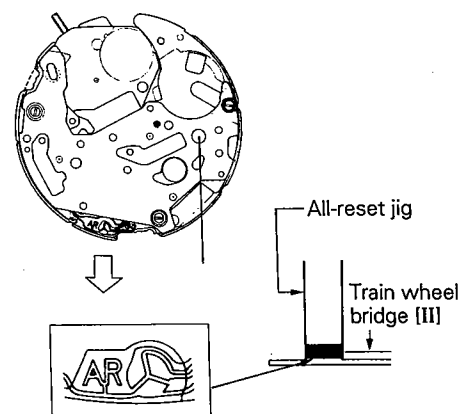

4 With the lead bars applied, press © button one time.

5 With the lead bars applied, return the crown to the normal position.

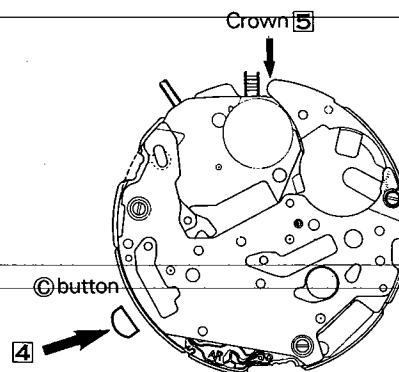

6 After the tester pointer is stabilized, read the current consumption.  
**3.1  $\mu$ A max. → OK**

After the battery is replaced, the information in IC in the watch is not matched to the positions of the calendar and world time hands.  
To operate each hand correctly, perform the initial setting operation, then set each hand.

# §6. DISASSEMBLY AND ASSEMBLY OF THE MODULE

● Lubrication narjubs

- ⊗ : A-Lube oil
- ⊕ : V-Lube oil
- ⊙ : CH-1 oil
- ⊖ : F-Lube oil

\* Three screws marked \*1 are used to fix CAL 604 block from dial side.

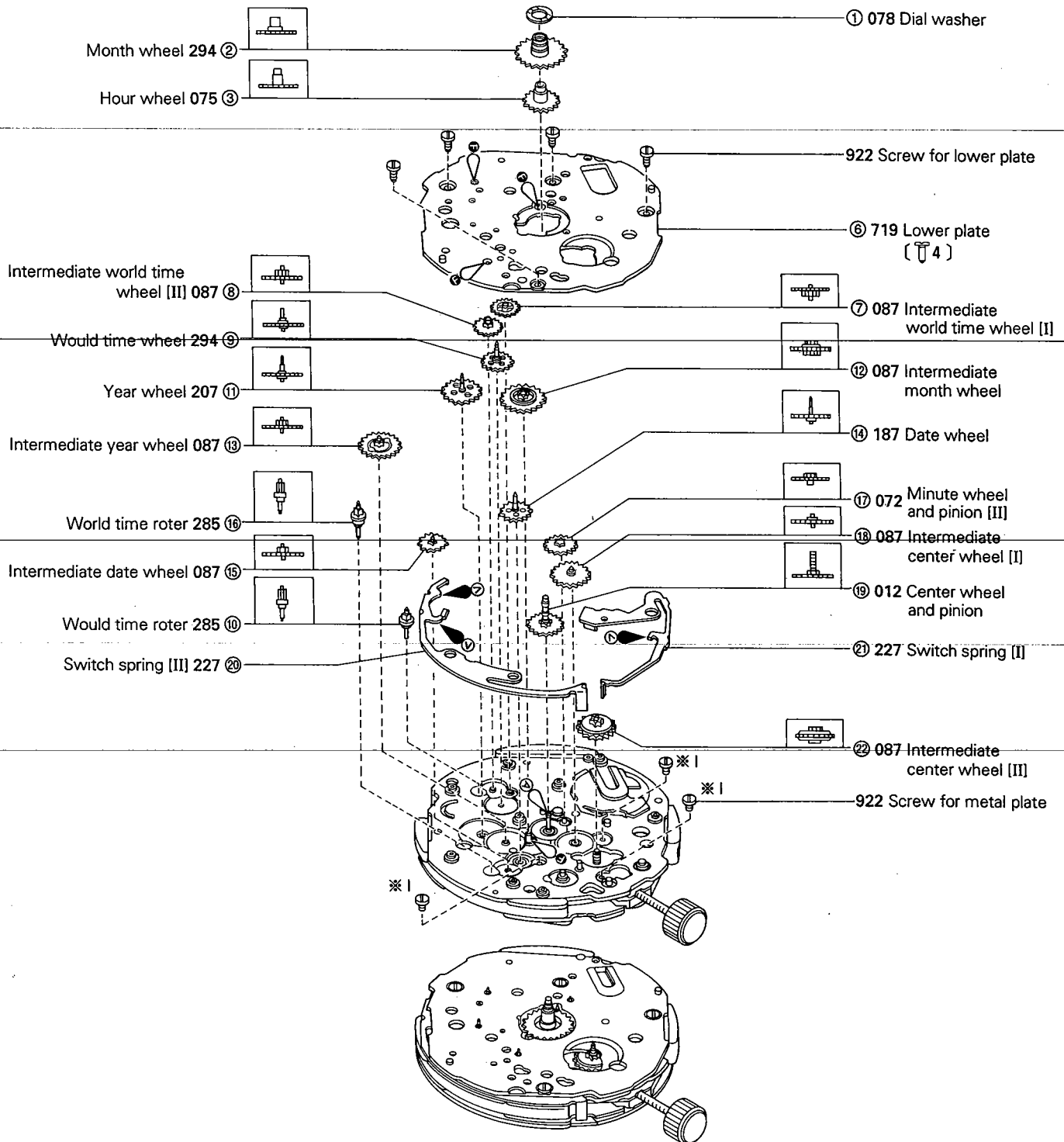

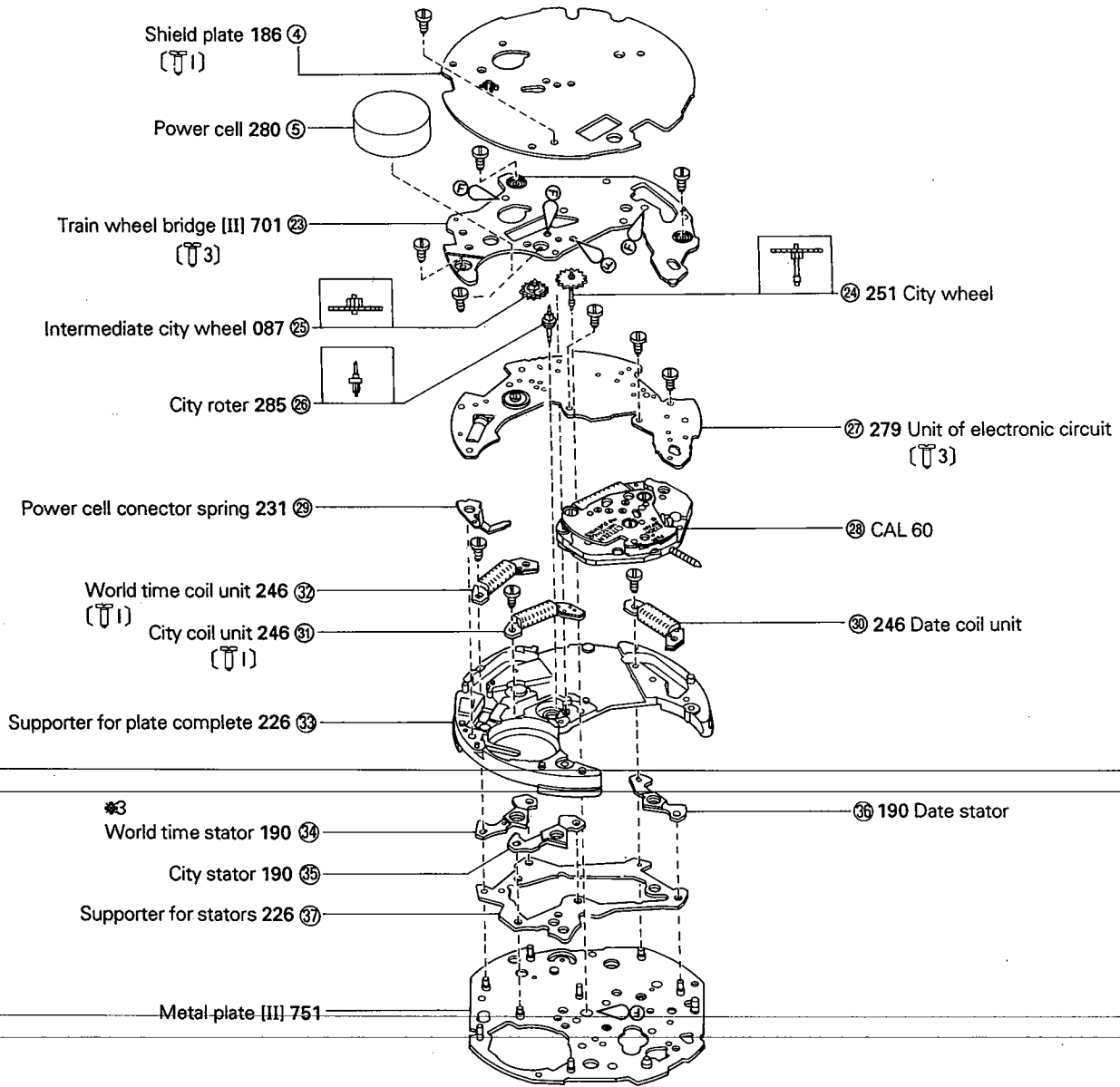

\*3 The world time stator has one more round hole near its center than other stators, thus the former can be distinguished. The date stator and city select stator are the common parts.

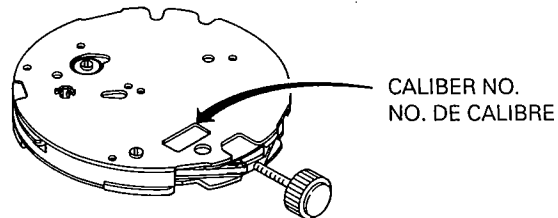

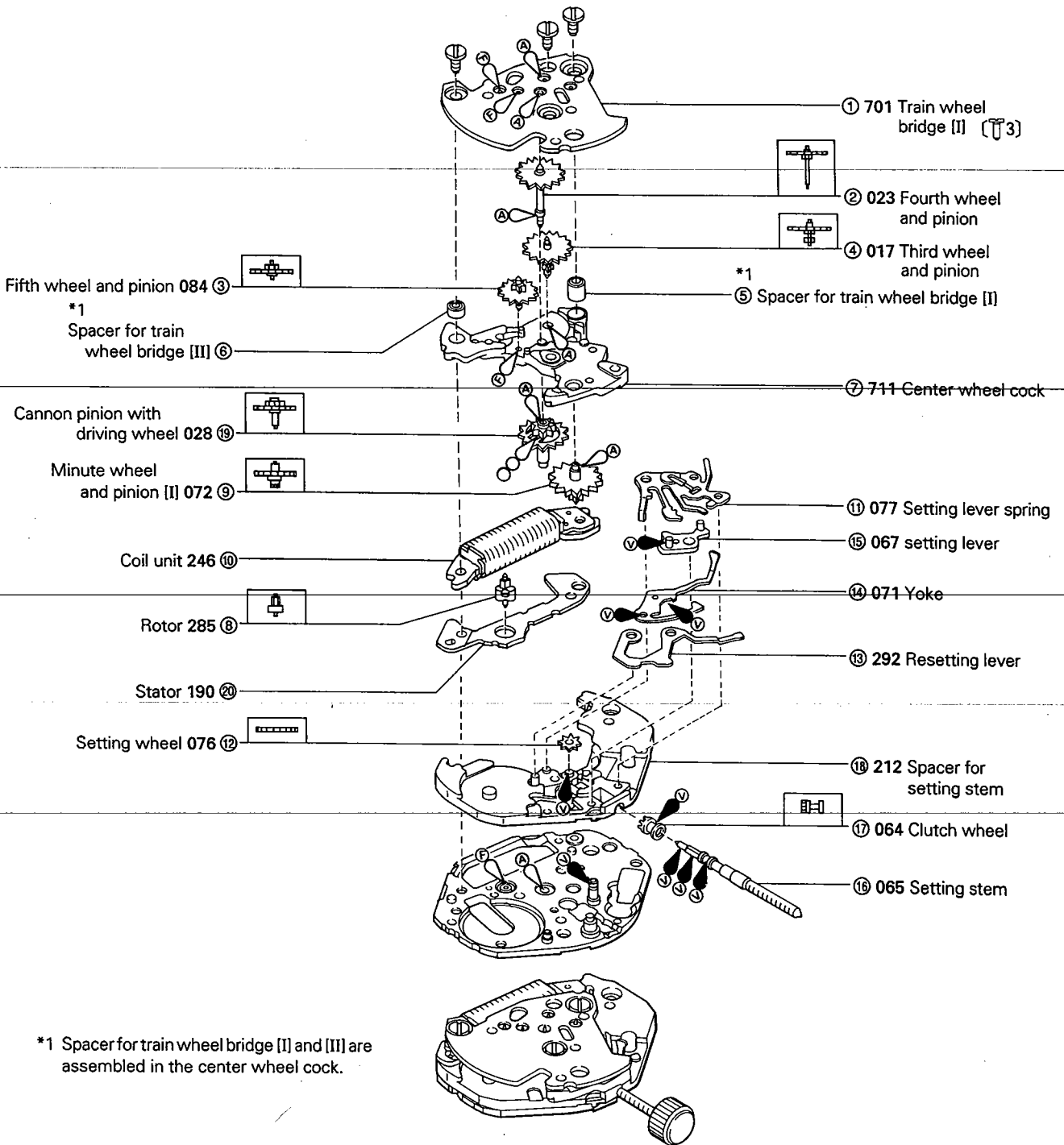



## PRECAUTIONS IN DISASSEMBLY AND ASSEMBLY

1. The world time stator has one more round hole than other stators. The date stator and city select stator are the common parts.
2. Since the intermediate second wheel and pinion (II) is fitted by pressing, pry it up with the tip of a screwdriver when removing it.
3. Install the minute wheel and pinion (II) with the pinion up.

### Arrangement of train wheels on dial side

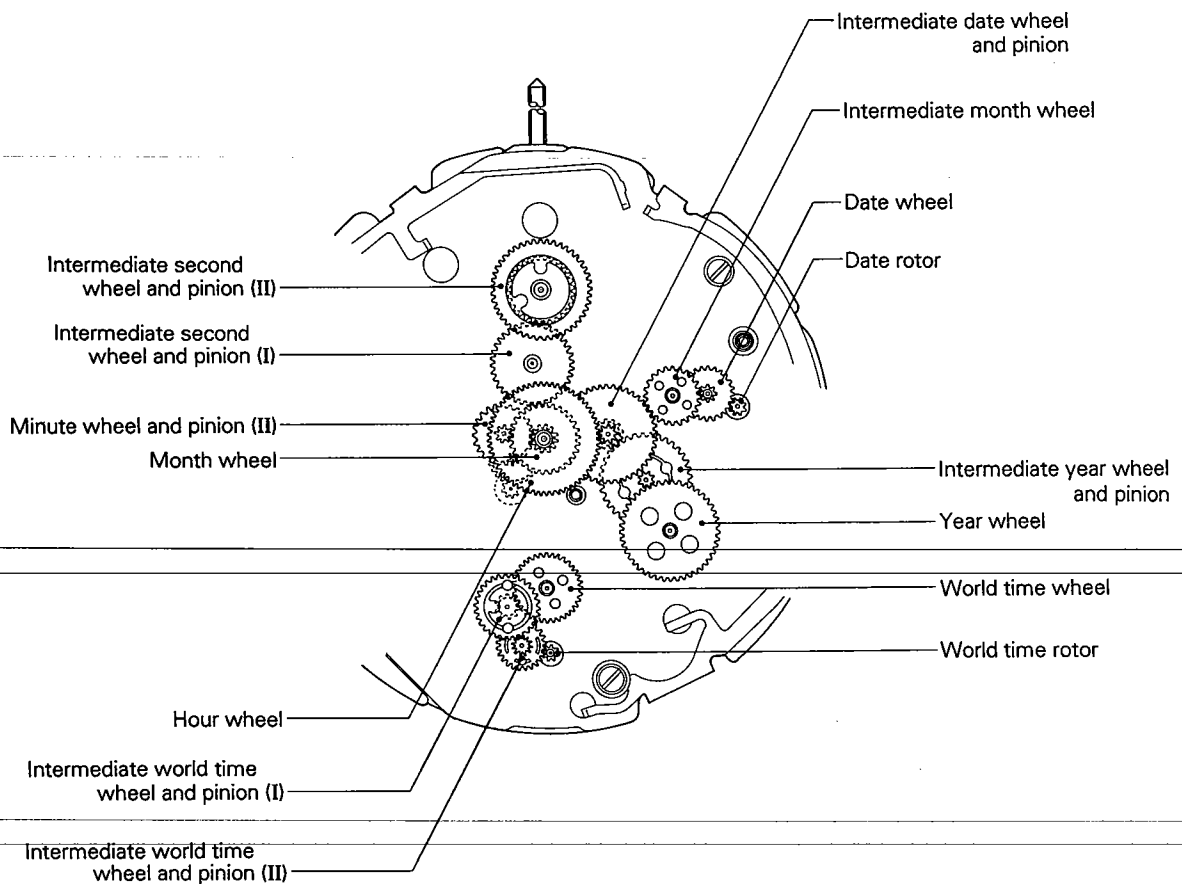

## §5. INSPECTION AND ADJUSTMENT METHOD OF MODULE

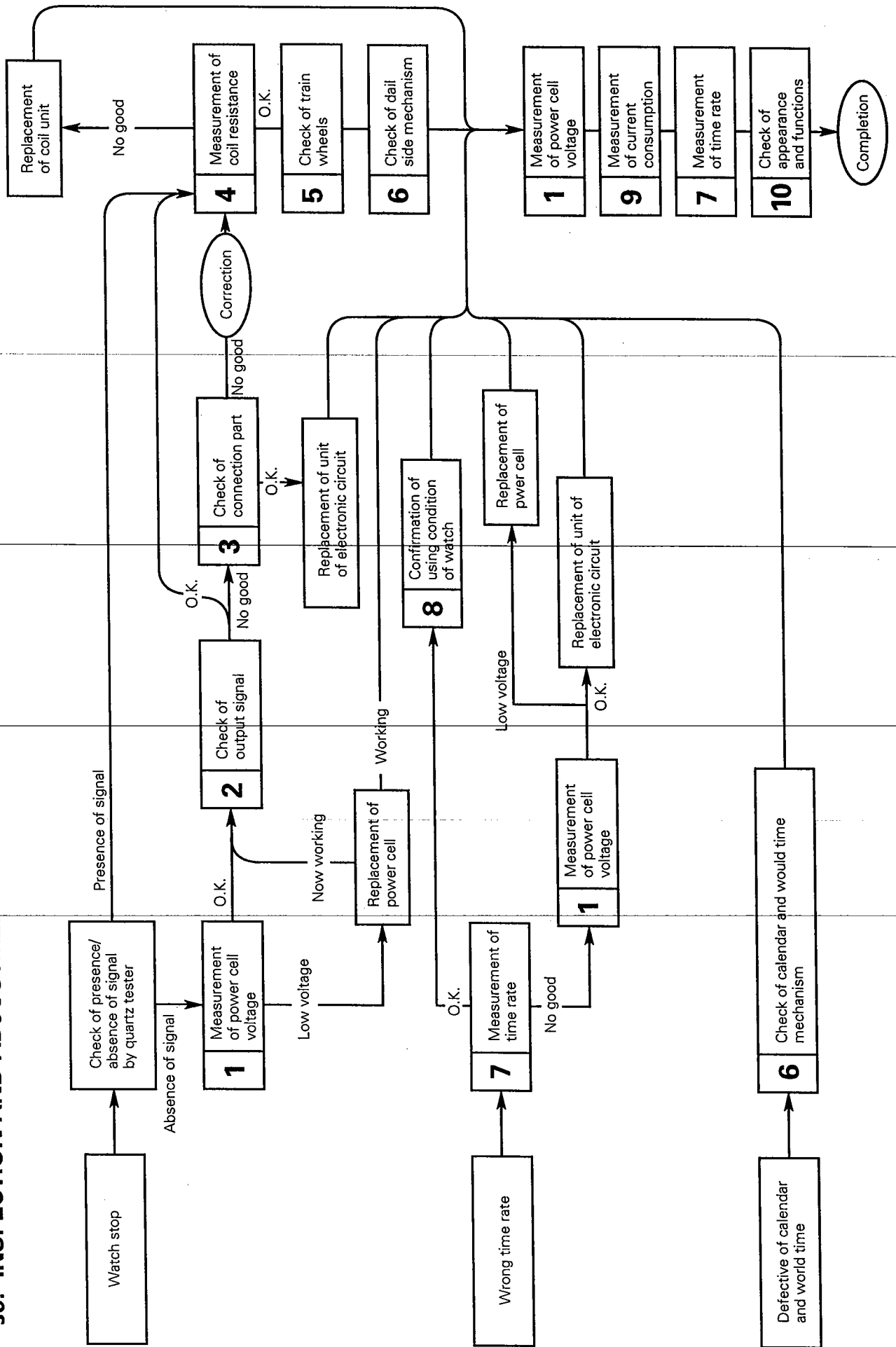

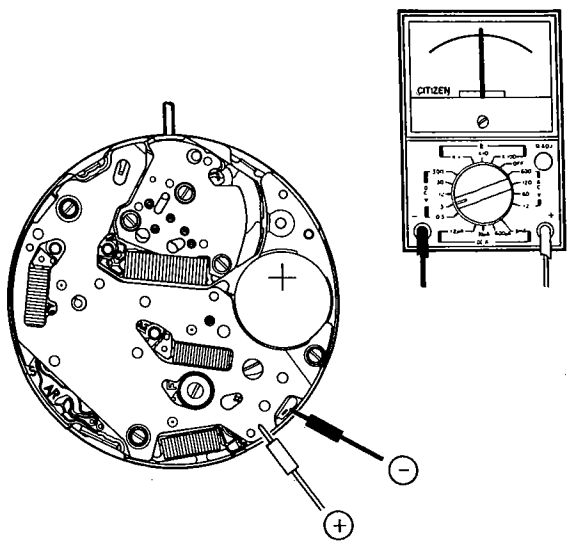
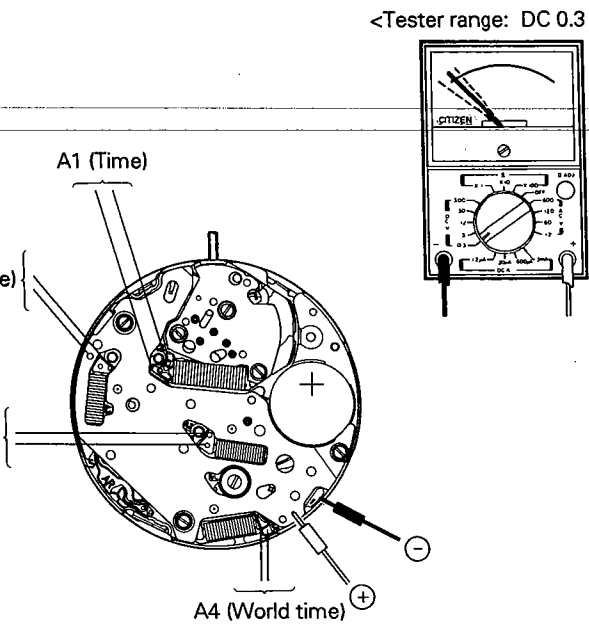
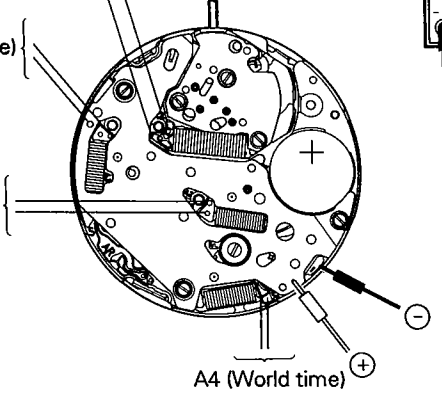
Check items	Method	Results and repair procedure
<p>① Measurement of power cell voltage</p>	<p>* Refer to Technical Manual, Basic Course II-1-a for the setting procedure of the tester.</p> <p>&lt;Tester range: DC 3V&gt;</p> 	<ul style="list-style-type: none"> <li>• Over 1.5 V → Non-defective</li> <li>• Under 1.5 V → Replace the power cell</li> </ul>
<p>② Check of output Signal</p>	<p>Confirm that the crown is at the normal position. The polarities of the lead bars do not affect the result of measurement.</p> <p>* Measuring method</p> <ul style="list-style-type: none"> <li>• A1 output signal: Measure with the crown at the normal position.</li> <li>• A2 output signal: Measure with the crown at the normal position and (A) or (B) button pressed.</li> </ul>	
	<ul style="list-style-type: none"> <li>• A3 output signal: Measure with the crown at the first position and (B) button pressed.</li> <li>• A4 output signal: Measure with the crown at the first position and (C) button pressed.</li> </ul> <p>&lt;Tester range: DC 0.3 V&gt;</p> 	<ul style="list-style-type: none"> <li>• A1 output signal (Timer) Tester pointer swings at interval of 1 sec. → OK</li> </ul>
	<p>A1 (Time)</p> <p>A3 (Year/Month/Date)</p> <p>A2 (City select)</p> <p>A4 (World time)</p> 	<ul style="list-style-type: none"> <li>• A2 output signal (city select)</li> <li>• A3 output signal (Year/Month/Date)</li> <li>• A4 output signal (World time) Tester pointer swings. → OK</li> </ul>

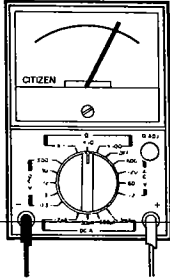
Check items	Method	Results and repair procedure
<p>③ Check of connection part</p>	<p>* Refer to the analog part of Technical Manual, Basic Course II-2-a.</p> <p>If the output signal cannot be obtained for checking, dust may be caught between electronic circuit unit and each part.</p> <p>When the fixing screws of the electronic circuit unit are loosened, the output signal may not be obtained. Tighten those screws securely.</p>	<ul style="list-style-type: none"> <li>Dust and dirt → Remove</li> </ul>
<p>④ Measurement of coil resistance</p>	<p>* Refer to Technical Manual, Basic Course II-1-c for the setting procedure of the tester.</p> <p style="text-align: center;">&lt;Tester range: X100Ω&gt;</p> <div style="text-align: center;">  </div>	<p>Resistance</p> <ul style="list-style-type: none"> <li>Coil unit <b>2.1 kΩ ~ 2.5 kΩ</b> → Non-defective</li> <li>Year coil unit/Date coil unit/ Day coil unit <b>2.0 kΩ ~ 2.4 kΩ</b> → Non-defective</li> </ul>
<p>⑤ Check of train wheel</p>	<p>* Refer to Technical Manual, Basic Course II-2-b.</p> <ol style="list-style-type: none"> <li>Confirm all the gears are meshed smoothly.</li> <li>Confirm reset lever works securely.</li> <li>Confirm all the parts are properly lubricated.</li> </ol>	
<p>⑥ Check of calendar and world time</p>	<p>If the calendar and world time are not correct, correct them according to the following procedure.</p> <p>① Check the initial setting. Press the © button with the crown at the normal position for more than 3 seconds and confirm the calendar and world time hands indicate the top (12 o'clock).</p> <p>* If the initial setting of the hands is correct but the indication is not correct, check the related wheels and pinions for deformation, lack of oil, etc.</p>	<ul style="list-style-type: none"> <li>The calendar and world time hands are not set to initial positions. → Perform initial setting.</li> </ul>

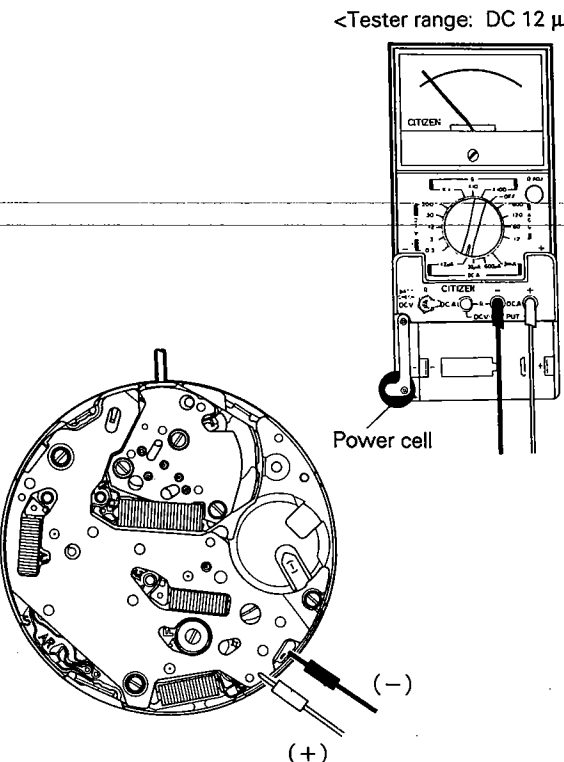
Check items	Method	Results and repair procedure
<p>⑦ Measurement/adjustment of time rate</p>	<p>* Refer to Technical Manual, Basic Course II-2-d.</p> <p>Measure the time with CITIZEN QUARTZ TESTER and adjust it if necessary.</p> <ul style="list-style-type: none"> <li>• Measurement of time rate The major time can be measured with the tester in any range.</li> <li>• Adjustment of time rate Adjust the time rate with the trimmer capacitor.</li> </ul> <p><b>Do not measure the time rate under the direct sunlight or incandescent lamp. If measured under them, the time rate may shift and may not be measured correctly.</b></p>	
<p>⑧ Check of calendar mechanism</p>	<p>* Refer to Technical Manual, Basic Course II-2-e.</p> <ol style="list-style-type: none"> <li>1. Since the accuracy may be affected by the environment of the watch, confirm the using condition of the watch (Magnetism, extremely high or low temperature and humidity, impacts, etc).</li> <li>2. Confirm how many days have passed after the time was set last time.</li> </ol>	
<p>⑨ Measurement of current consumption</p>	<p>* Refer to Technical Manual, Basic Course II-1-f for the setting procedure of the tester.</p> <p>* See for 1. Measurement of current consumption (Page 12) of this manual.</p> <p>&lt;Tester range: DC 12 <math>\mu</math>A&gt;</p> 	<ul style="list-style-type: none"> <li>• <b>Under 3.1 <math>\mu</math>A</b> → Non-defective</li> <li>• <b>Over 3.1 <math>\mu</math>A</b> → Measure the electronic circuit unit separately. Measurement of the separate electronic circuit unit</li> <li>• <b>Under 2.1 <math>\mu</math>A</b> → Non-defective</li> <li>• <b>Over 2.1 <math>\mu</math>A</b> → Replace the electronic circuit unit.</li> </ul>

Check items	Method	Results and repair procedure
	<p>* Precautions in measurement of current consumption</p> <p><b>If the module is exposed to the light of an incandescent lamp or the sun, much current may be consumed. The light of a fluorescent lamp does not affect the current consumption.</b></p>	
<p>⑩ Check of appearance and functions</p>	<p>* Refer to Technical Manual, Basic Course II-2-f.</p> <ol style="list-style-type: none"> <li>1. Confirm there is not dust, dirt, etc. on the dial.</li> <li>2. Confirm the crown and push-button works normally.</li> </ol>	