

S3. NAME AND FUNCTION OF EACH PART

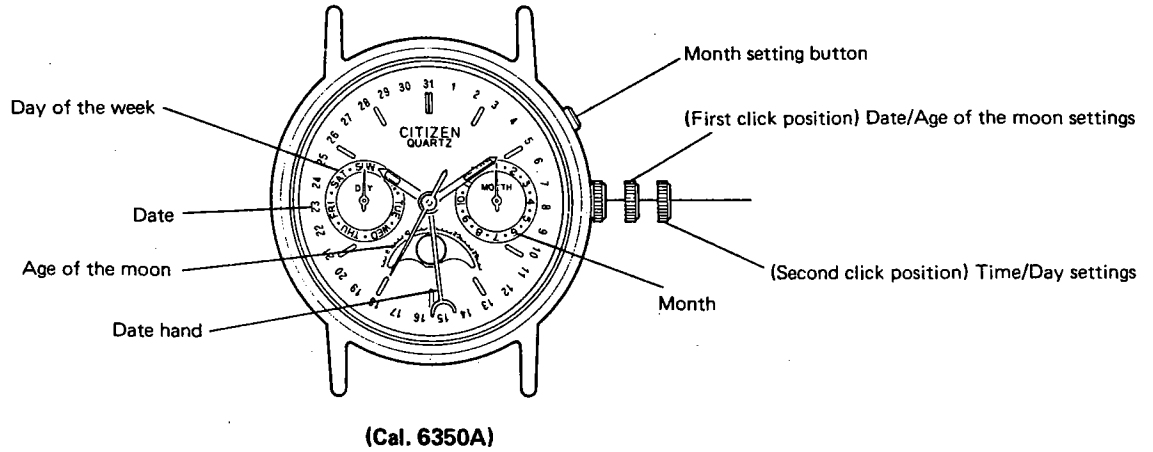

3-1. Setting each indication

a. Setting the day

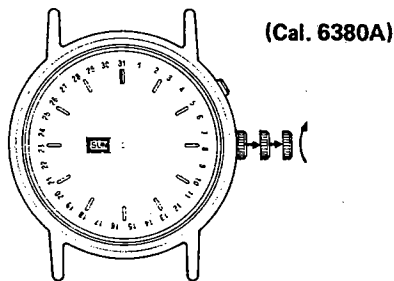
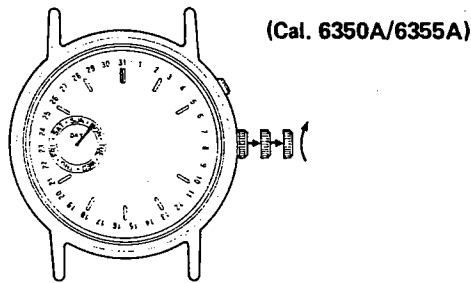

- Set the day by pulling out the crown to the second click position and rotating it forward (to rotate the hour and minute hands clockwise).
If the day is set by rotating the crown backward (rotating the hour and minute hands counter-clockwise), the date may not be changed.

Note:

The day is changed during the period from about 0:00 am to about 5:30 am.

b. Setting the normal time

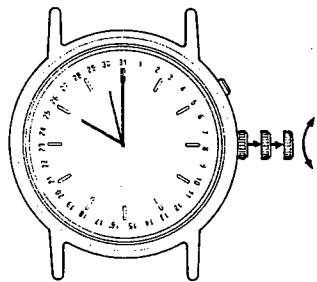

- Pull the crown out to the second click position when the second hand reaches the 12 o'clock position so that the second hand stops there. Then set the hour and minute hands. When setting the minute hand, first advance it by 4 to 5 minutes from the time it is to be set to, and then turn it back to the correct time.

Note:

Set the watch to a time am or a time pm correctly. (The day is changed during the period from about 0:00 am to about 5:30 am. After the time is set, push the crown back simultaneously with the time signal. The second hand will start running at the same time.

c. Setting the date

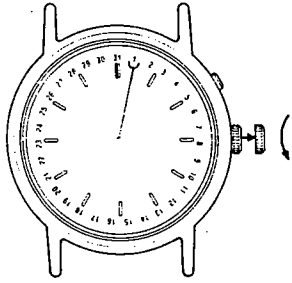

- Pull the crown out to the first click position and set the date quickly by rotating the crown backward.

If the date is set quickly between around 9:00 pm and around 0:00 am, the date will not change correctly the next day.

d. Setting the month

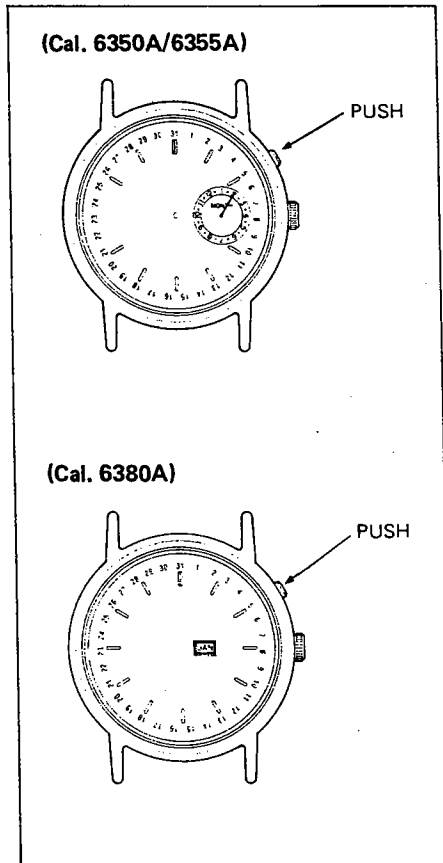

- Each time the month setting button is pushed, the month is moved clockwise by one month. If the button is not pushed to the end, the month is not changed perfectly. Be sure to press firmly.

Notes:

- Do not change the month while the date hand lies between the 26th and the 31st. Move the date hand out of this period to set the month. After this operation, set the date hand again.

- When the time passes from a end of short months (less than 31 days) to a 31-day month the month hand needs to be corrected. If the date hand is changed, the month is also changed automatically.

(Cal. 6350, 6355)

- The month starts changing at about 0:00 am on the 31th and finishes changing at about 0:00 am on the 1st of the next month. (The month is kept between this month and the next month during 31th.)

(Cal. 6380)

- The month changes around midnight of the 31st.

e. Setting the age of the moon and how to read it.

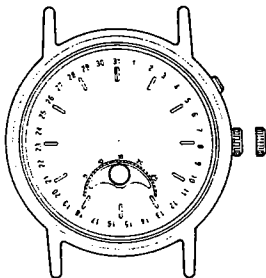

f. How to set and read age of the moon (Cal. 6350/6380)

- * This function indicates the age of the moon, but does not display the shape of the moon.
- * Use the moon dial only as a guide to the age and phase of the moon when reading and setting the watch.

1) Setting the age of the moon

- In case the watch is equipped with the age of the moon scale

(1) Confirming today's or tomorrow's age of the moon

Check today's or tomorrow's age of the moon with a newspaper.
If tomorrow's age of the moon is found, subtract one day from it.

(2) Setting the age of the moon (Example: age of the moon: 4.4)



Pull the crown out to the first click position and rotate the moon mark clockwise until the center of the moon comes to around the position of 4.4 of the age of the moon scale.

- In case the watch is not equipped with the age of the moon scale

In this case, when the age of the moon shown in a newspaper, is 0, 7, 15 or 22, set the moon mark to the corresponding position of the age of the moon as shown in 2) "How to read the age of the moon" below.

The age of the moon can be set more accurately if it is set when it is 0 (New moon) or 15 (Full moon).

2) How to read age of the moon (Example of indication)

1	New moon Age of the moon: 0 (Spring tide)	3	First quarter moon Age of the moon: Approx. 7 (Neap tide)
5	Full moon Age of the moon: Approx. 15 (Spring tide)	7	Last quarter moon Age of the moon: Approx. 22 (Neap tide)

- * The level of the tide can be seen from the indicated age of the moon.
- The age of the moon can be set more accurately if it is set when it is the New moon (the moon mark cannot be see at all — Age of the moon: 0) or the Full moon (the moon mark is at the top (position of 12 o'clock) — Age of the moon: 15).

3) What is the age of the moon

- Waxing and waning of the moon

The waxing and waning of the moon are caused by the change of the positions of the sun and moon viewed from the earth.

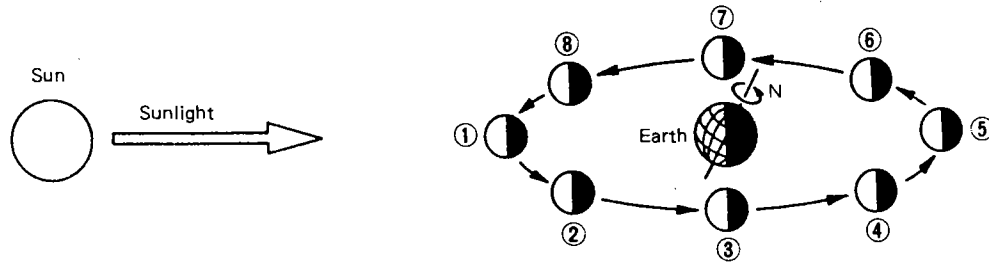

When the moon is at position (1) shown above (the sun and moon are in the same direction), the moon viewed from the earth is illuminated from its back. The moon is called the new moon at this time.

The moon can be seen at various positions as shown below.

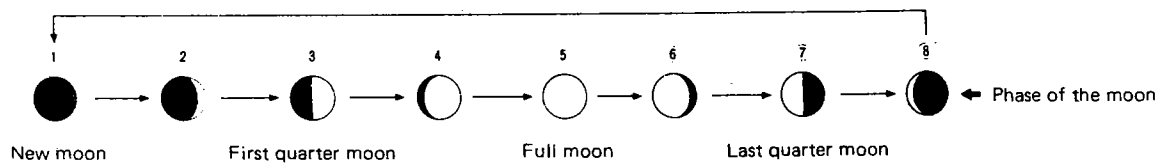

The moon waxes and wanes repeatedly in order of (1) – (8) – (1).

- The age of the moon

The age of the moon is indicated in units of days. The average period from a new moon to the next new moon is equivalent to about 29.5 days.

54. ASSEMBLY DRAWING OF HANDS AND DIALS

Cal. 6355

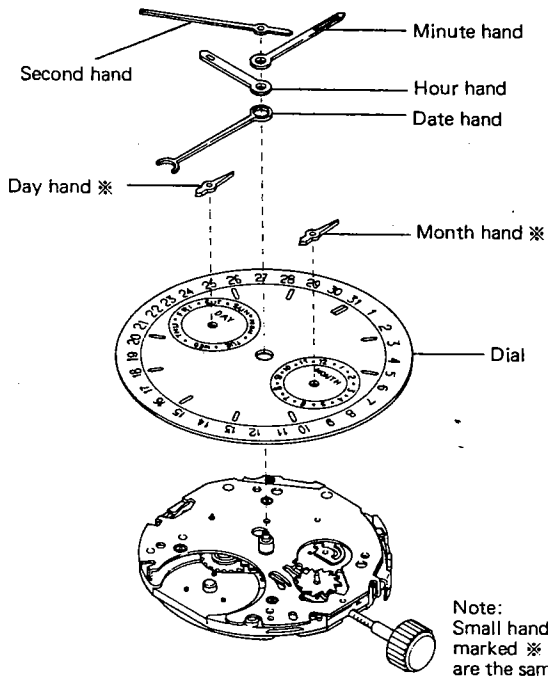

Cal. 6350

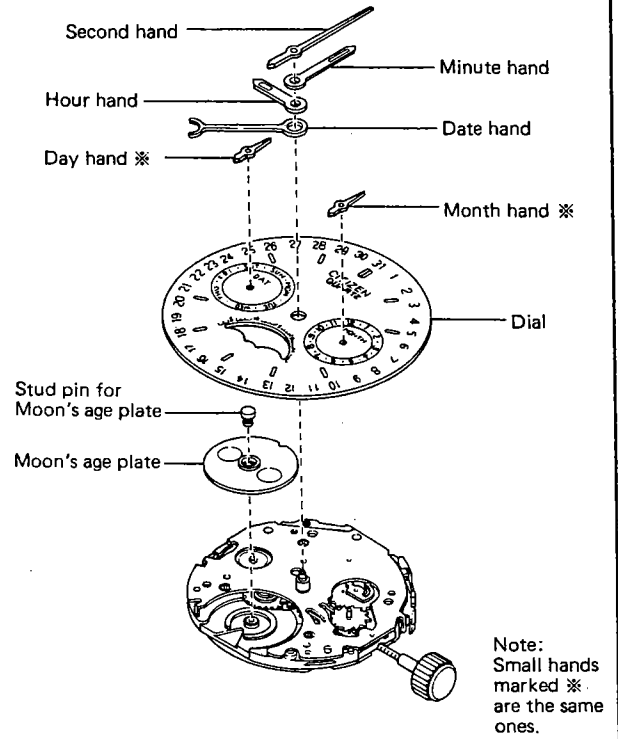

Cal. 6380

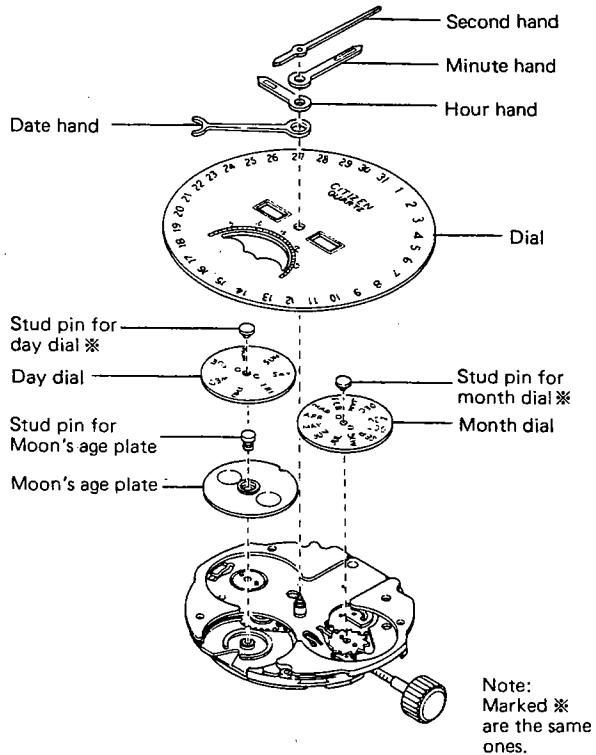

55. HOW TO SET THE HANDS

Since the following work is important for determining the correct changeover time of each indication, perform it securely.

(CAL. 6355 and 6350)

- (1) Confirm that the teeth of the month wheel and the month jumper are set as shown in Fig. 1. If they are set as shown in Fig. 2, move the month wheel by one tooth with tweezers etc.
- (2) Mount the dial.
- (3) Mount the month hand, matching it to the center of the letters of month (It may be set to any month).
- (4) Pull out the crown to the first click position and turn it toward you (counterclockwise). When the month hand is changed, set the date hand to the 1st and fix it. (Since the month hand is changed by two steps, mount the date hand when the month hand moves twice.)

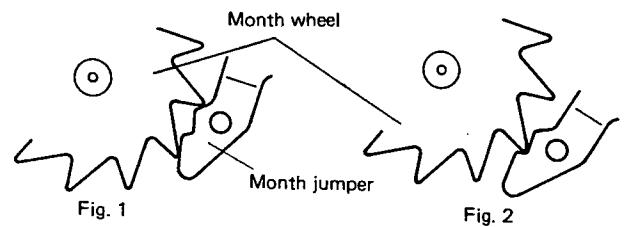
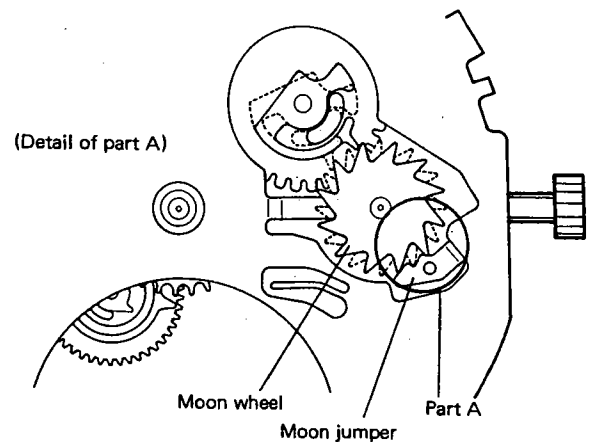

- (5) Pull out the crown to the second click position and turn it away from you (clockwise). Just after the date hand is changed to the 2nd, set the hour, minute and second hands to the correct time and fix them.
- (6) Mount the day hand, matching it to the center of the letters of the day (only when the hour, minute and second hands are indicating a time between 8:00 AM and 8:00 PM).
- (7) Move each hand to check for scratch, etc.

(CAL. 6380)

- (1) Mount the dial.
- (2) Pull out the crown to the first click position and turn it toward you (counterclockwise). When the month is changed, set the date hand to the 1st and fix it. (Since the month hand of CAL. 6380 is changed by one step, mount the date hand when the month is changed.)
- (3) Pull out the crown to the second click position and turn it away from you (clockwise). Just after the date hand is changed to the 2nd, set the hour, minute and second hands to the correct time and fix them.
- (4) Move each hand to check for scratch, etc.

56. DISASSEMBLY AND ASSEMBLY OF THE MODULE





Disassembly procedure of power cell side: ① ~ ②①

Disassembly procedure of dial side: ① ~ ①⑥ (CAL. 6350, 6355)

① ~ ②③ (CAL. 6380)

(Power cell side)

Lubrication markings

-  A lube
-  V lube
-  F lube
-  CH-1

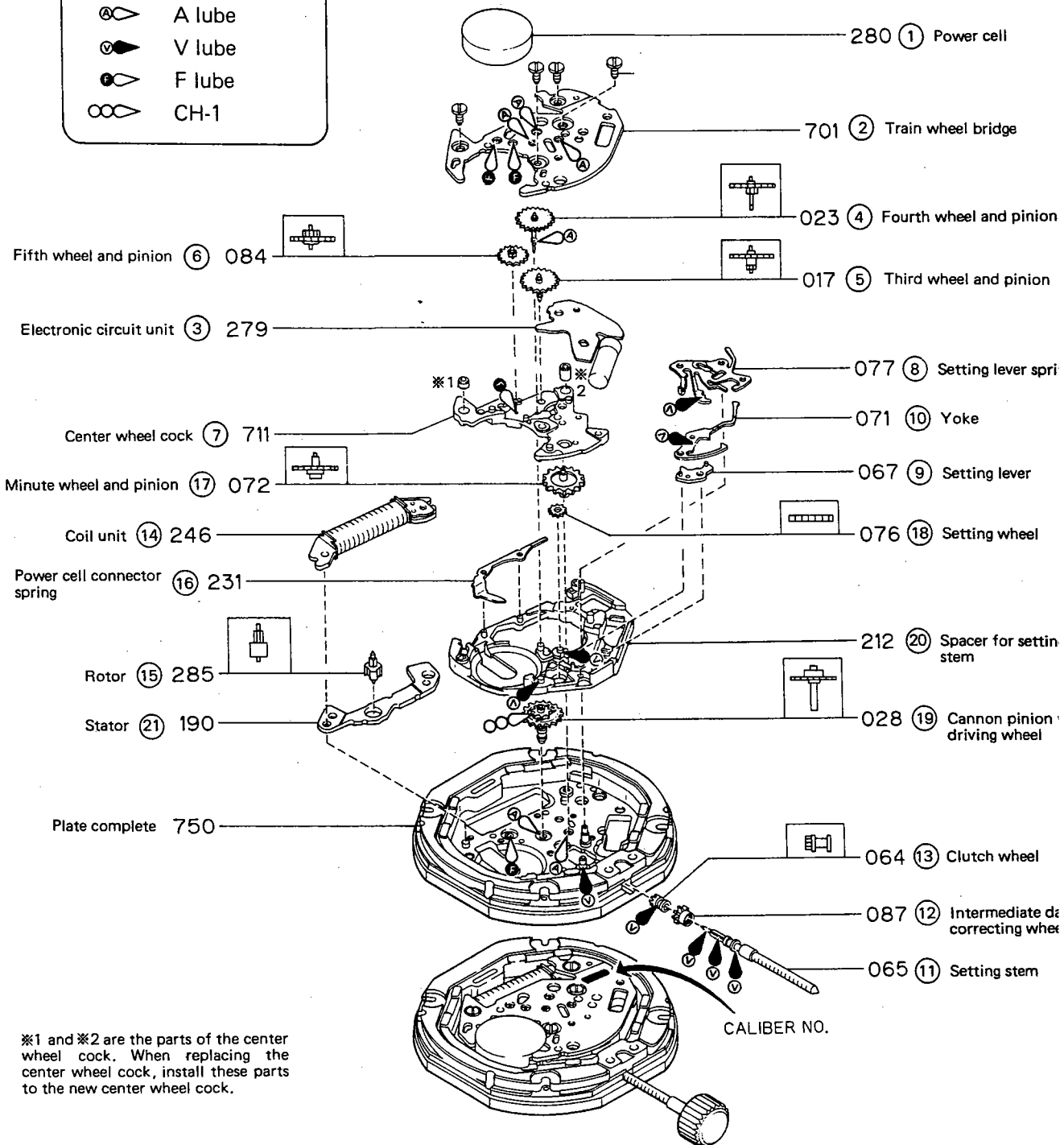

CAL. 6350, 6355

(Dial side)

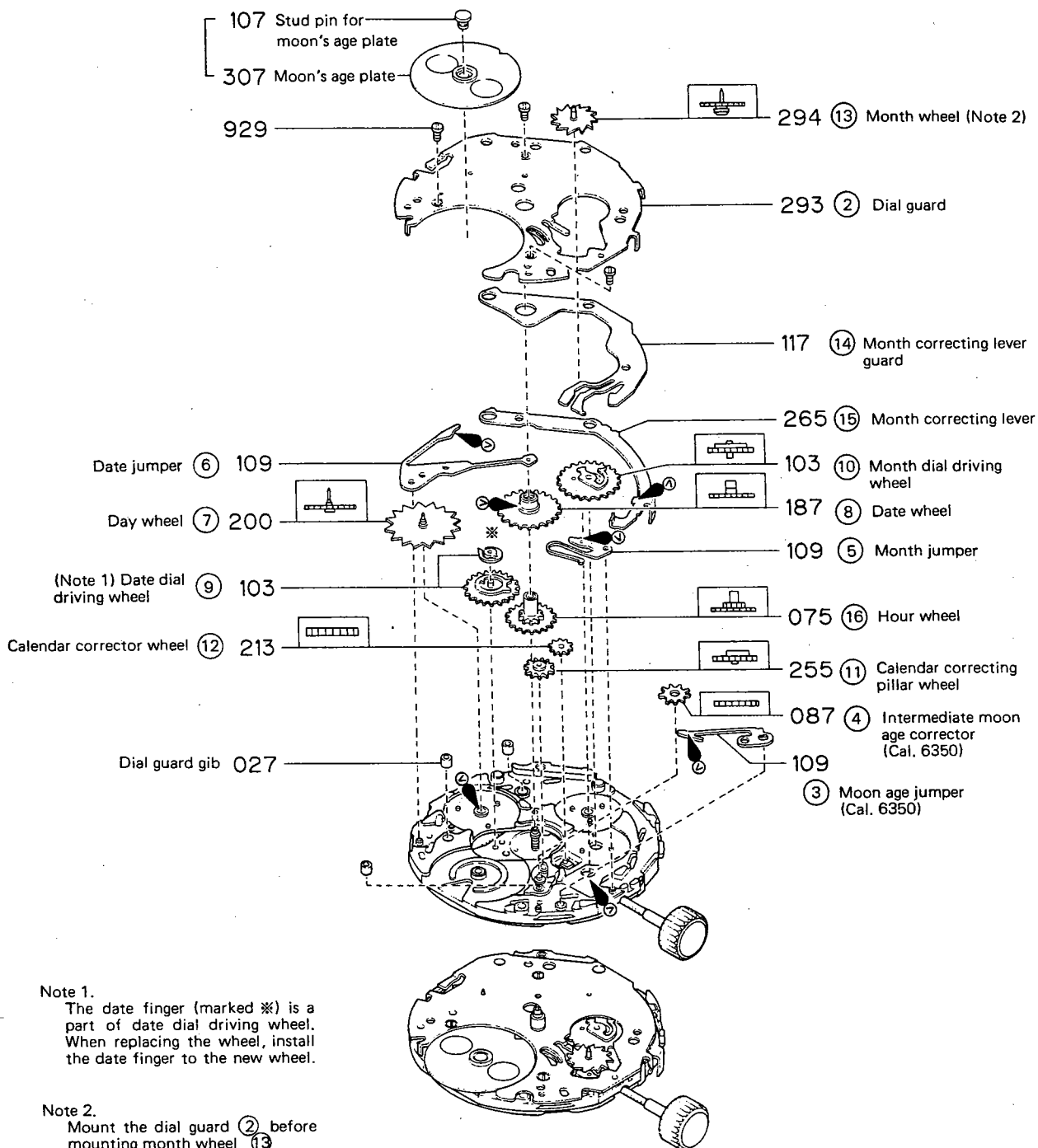

CAL. 6380

(Dial side)

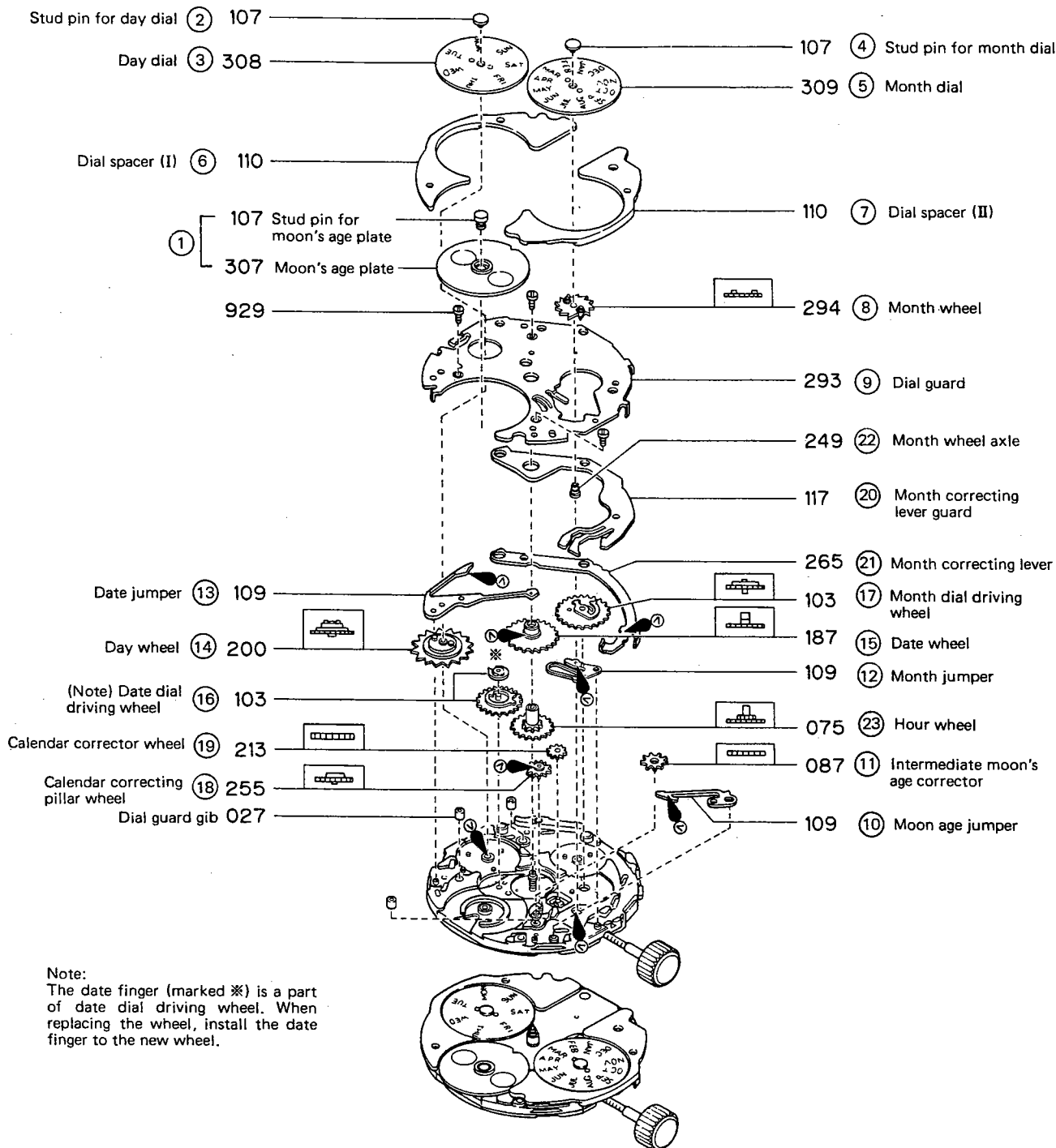

57. ARRANGEMENT OF PARTS (WHEELS) ON DIAL SIDE

(CAL. 6350)

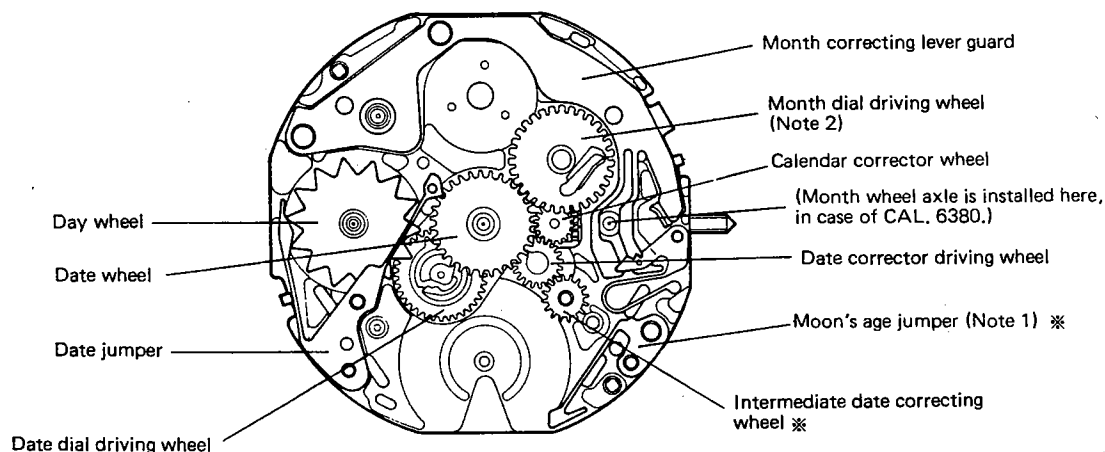

Note 1. Part marked ※ is not used in CAL. 6355.

- The dial guard, month wheel and moon's age plate are not shown in the above illustration of CAL. 6350. The arrangement of the parts of CAL. 6355 and 6380 is the same as CAL. 6350.
- Note 2. Even if the shapes of the parts in hand are different from the above illustration, they will function normally.

58. NOTES ON DISASSEMBLY AND ASSEMBLY

1. Handling of month wheel

(CAL. 6355, 6350)

Before mounting the moon wheel, mount the dial guard.

(CAL 6380)

Correctly set the moon wheel to the month wheel axle and month jumper.

Note 1. When mounting the month wheel, take care that it will not float or incline.

Note 2. Be sure to mount the month wheel in the correct position (Dowel pin must be directed up).

2. Handling of month dial (CAL. 6380)

- (1) Mount the month dial, matching the locating holes (two) of the month dial to the boss of the month wheel.
- (2) Fix the month dial with the pin. Drive in the pin with the grip of tweezers.
- (3) When removing the pin from the month dial, insert a screwdriver etc. between the month dial and pin, and pry the pin up.

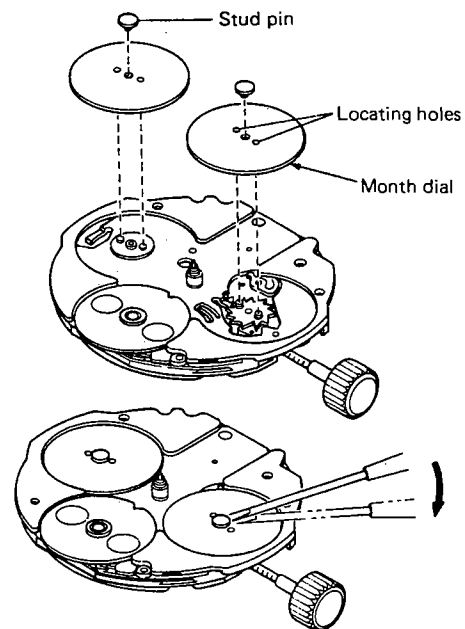

3. Handling of day dial (CAL. 6380)

- (1) Similarly to the month dial, mount the day dial, matching the locating hole (two) of the day dial to the boss of the day wheel. At this time, confirm that the printed letters of day dial (any day) is matched to the hole of the dial. If they are not matched, reverse the positions of the holes of the day dial, so that they will be matched to the hole.
- (2) Fit and remove the stud pin similarly to that of the month dial.

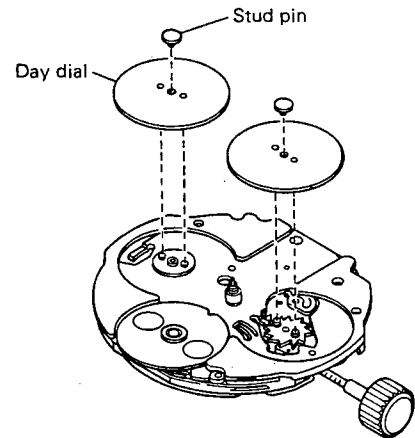

4. Handling of moon age plate (CAL. 6350, 6380)

- (1) Set the moon's age plate, matching it to the axle of the module.
- (2) Move the moon's age jumper outward with tweezers (take care not to open it too much), and mesh it with the teeth of the moon age plate.
- (3) Fit the stud pin similarly to those of the day and month dials. When removing the moon's age dial and pin, remove the moon's age plate and moon age wheel together with tweezers, and the moon's age plate and pin can be removed together.

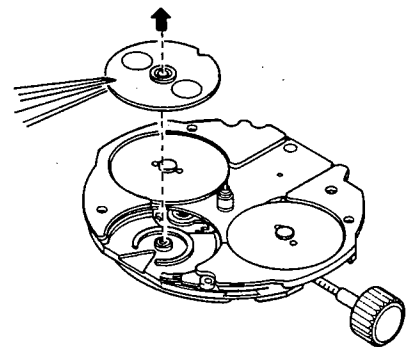
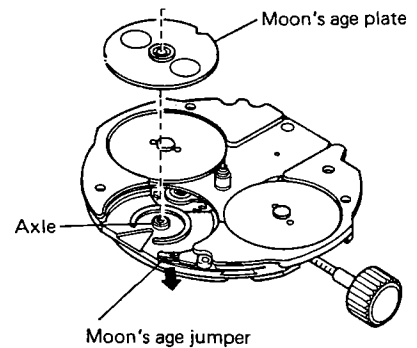

8 FLOW CHART OF TROUBLESHOOTING AND ADJUSTMENT

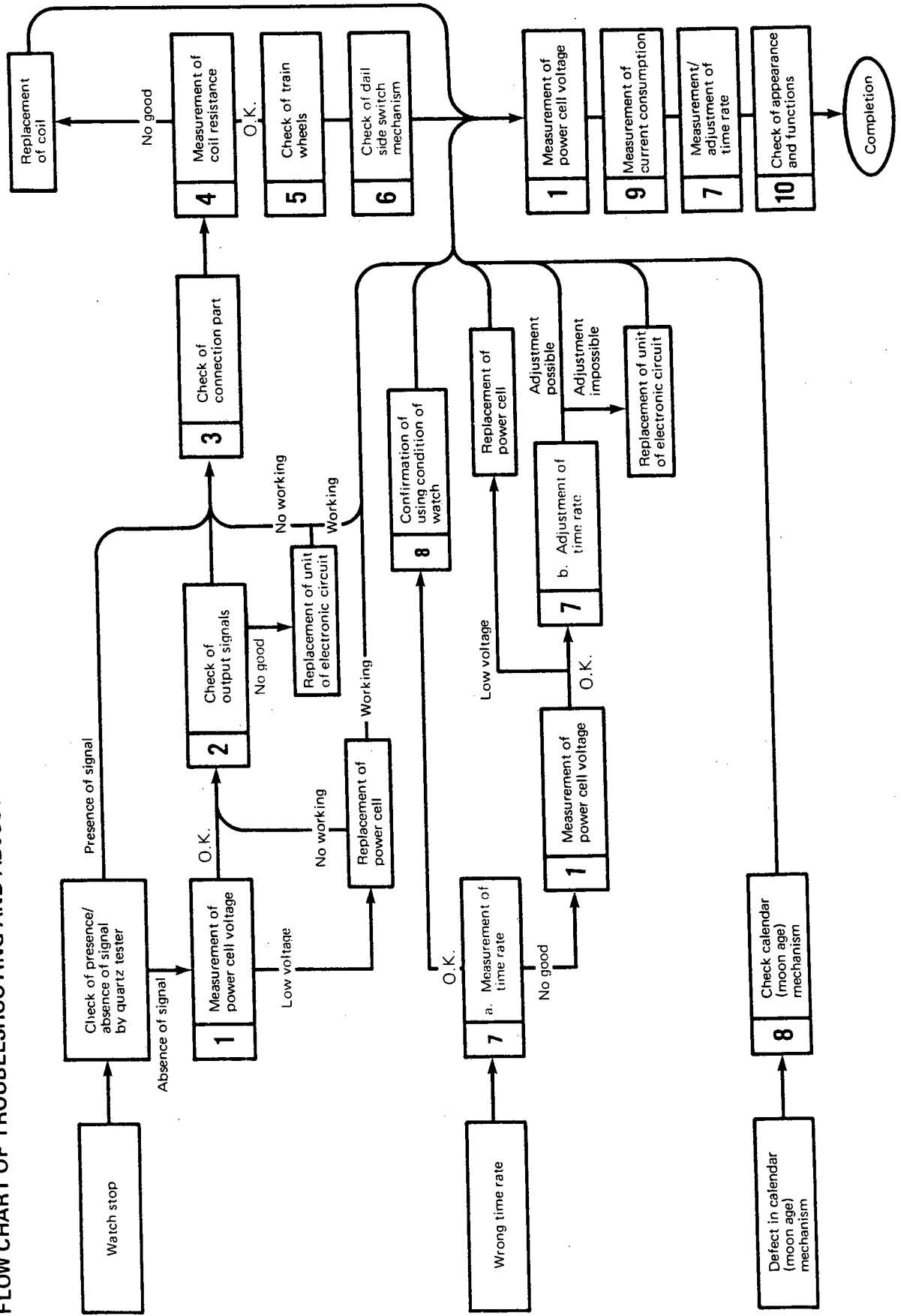

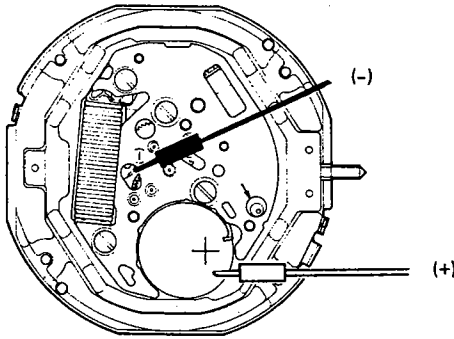
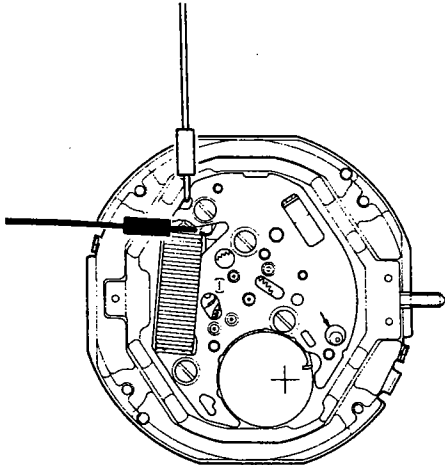
Check points	How to check	Results and Treatment
<p>① Measurement of power cell voltage</p>	<p>[Refer to Technical Manual, Basic Course II-1-a for the setting procedure of the tester.]</p> <p>< Tester range: D.C. 3V ></p> 	<p>Over 1.5V → Non-defective</p> <p>Under 1.5V → Replace the power cell</p>
<p>② Check output signal</p>	<p>[Refer to Technical Manual, Basic Course II-1-b for the setting procedure of the tester.]</p> <p>< Tester range: D.C. 0.3V ></p>  <p>(The resistor does not have polarities.)</p>	<p>The tester pointer swings every second. → Non-defective</p> <p>The tester pointer does not swing. → Check the connections.</p> <p>The connections are normal → Replace the electronic circuit unit.</p>
<p>③ Check connection part</p>	<p>[Refer to Technical Manual, Basic Course II-2-a.] Confirm that there are no loose screws, dust or stains in the connections.</p> <p>a) A loose screw in the electronic circuit unit may prevent the transmission of the driving signals.</p> <p>b) Dust or stains on the coil or the pattern of the electronic circuit unit will prevent the circuit from conducting.</p>	

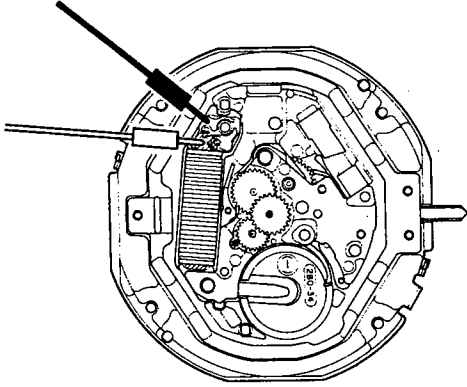
Check points	How to check	Results and Treatment
<p>④ Measurement of coil resistance</p>	<p>[Refer to Technical Manual, Basic Course II-1-c for the setting procedure of the tester.]</p> <p>○ Remove the electronic circuit unit when measuring the resistance.</p> <p style="text-align: center;">< Tester range: R x 10Ω ></p>  <p style="text-align: center;">(The signal does not have polarities.)</p>	<p>2.1kΩ ~ 2.5kΩ → Non-defective</p> <p>Outside range of 2.1kΩ ~ 2.5kΩ → Replace the coil unit.</p>
<p>⑤ Check train wheels</p>	<p>[Refer to Technical Manual, Basic Course II-2-b.]</p>	
<p>⑥ (Calendar mechanism) Check dial side mechanism (Check moon age mechanism)</p>	<p>[Refer to Technical Manual, Basic Course II-2-c.]</p> <p>Or see "5. Mounting procedure of hands and precautions".</p>	
<p>⑦ Measurement of time rate</p>	<p>[Refer to Technical Manual, Basic Course II-2-d.]</p> <p>○ Since this watch uses the D.F.C. (digital frequency control) method and has no control terminal, there is no way of adjusting its time rate in the field. (Measurement is made in a 10-second range.)</p>	<p>The watch loses or gains a substantial amount of time → Replace the electronic circuit unit.</p>
<p>⑧ Confirmation of using condition of watch</p>	<p>[Refer to Technical Manual, Basic Course II-2-e.]</p>	

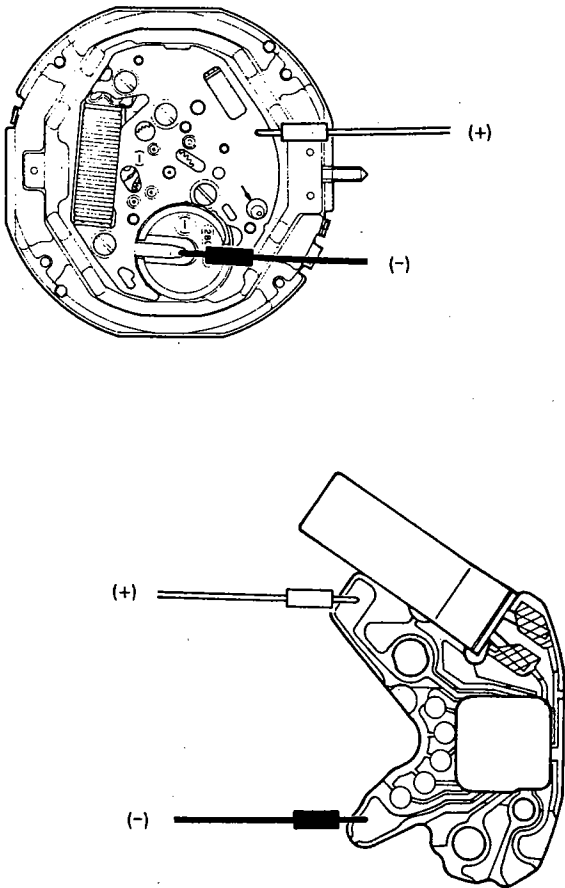
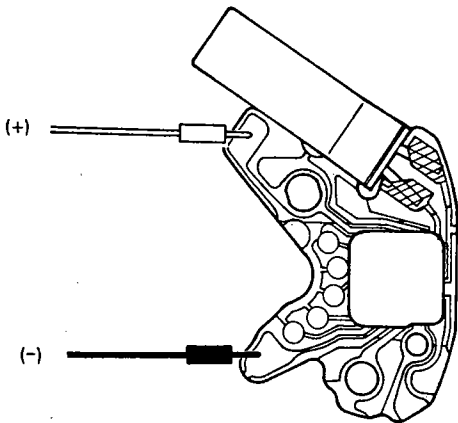
Check points	How to check	Results and Treatment
<p>⑨ Measurement of current consumption</p>	<p>[Refer to Technical Manual, Basic Course II-1-f for the setting procedure of the tester.]</p> <p>< Tester range: D.C. $12\mu\text{A}$ > Place the power cell in the adapter.</p>   <p>Influence of light</p> <p>Avoid measuring current consumption under an incandescent lamp or the direct rays of the sun, because it may cause the current value to increase.</p> <p>The light of a fluorescent lamp has no influence on the current value.</p>	<ul style="list-style-type: none"> ● Current consumption of the module <ul style="list-style-type: none"> Under $1.2\mu\text{A}$ → Non-defective Over $1.2\mu\text{A}$ → Measure the electronic circuit unit separately. ● Measurement of the separate electronic circuit unit <ul style="list-style-type: none"> Under $0.3\mu\text{A}$ → Non-defective Over $0.3\mu\text{A}$ → Replace the electronic circuit unit. <div style="border: 1px solid black; padding: 5px; margin-top: 10px;"> <p>When the current consumption of the module shows a high value, but that of the separate electronic circuit unit is normal → There may be a problem somewhere outside the circuit. Therefore, inspect the watch for stains, lubrication conditions and deformed parts, and remove the cause of the high load.</p> </div>
<p>⑩ Check appearance and functions</p>	<p>[Refer to Technical Manual, Basic Course II-2-f.]</p>	