

TECHNICAL INFORMATION

CITIZEN QUARTZ

Cal. No. 438❖❖

Cal. No. 439❖❖

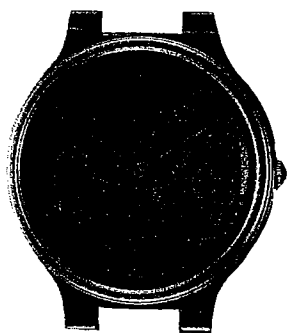

(Cal. No. 438XX)



(Cal. No. 439XX)

■1. OUTLINE

The products are analog quartz watches with a second hand, which display a representation of the constellations which changes with the time.

■2. SPECIFICATIONS

Caliber No.		4380A-01	4390A-01
Type		Analog quartz watch (with a center second hand)	
Module size (mm)		22.6 x 18.0 x ϕ 23.7 x 3.9 ^t	
Accuracy		\pm 20 sec./month (when used at normal temperatures)	
Oscillation		32,768 Hz	
Integrated circuit		C/MOS-LSI 1 unit	
Effective temp. range		-10°C ~ +60°C	
Converter		Bipolar step motor	
Time rate adjustment		D.F.C. (without a control terminal)	
Time rate measurement		10 seconds	
Additional functions	A second hand stopping device, a power saving switch	Yes	
	Constellations display	Constellation dial revolution speed: 366 rev./365 days	
		Constellation dial revolution cycle: approx. 23 hours 56 minutes 3.9 seconds	
	A planisphere function	Yes	
	Twilight identification function	Yes	
	Indication of sunshine hours and remaining sunshine hours	Yes	
Indication of the sun's mean position	Yes		
Power cell	Part No.	280-39 1 piece	
	Cell code	RS626SW	
	Size (mm)	ϕ 6.8 x 2.6 ^t	
	Voltage	1.55V	
	Capacity	26mAH	
	Life	Approx. 2 years	
Current consumption		Under 1.7 μ A (Module current value)	
Coil resistance		1.8k Ω ~ 2.4k Ω	
Remarks			

■3. HANDLING INSTRUCTIONS

1. Features

The constellation watch is an attractive three-hand analog watch. It shows the correct positions of the constellations as they move. It gives azimuth and altitude, positions and times for fixed stars, time for twilight and other functions useful in astronomical observation. It also has every-day functions that allow you to know the direction of the sun, the hours left until dawn or the remaining hours of daylight.

- Constellation display function which displays fixed stars with a visibility of 4.5 degrees or brighter (the maximum brightness of variable stars is displayed in red on the constellation dial), major constellations, the Milky Way, and ecliptic at 2,000 years.
- Constellation quick-read function that not only automatically displays the present positions of constellations but that can also be used as a constellation quick-read dial in which the constellation dial is independently turned.
- A solar mean position display function which shows the mean position of the sun on the ecliptic in the 1st, 11th and 21st of each month.
- A remaining hours of daylight and hour of sunlight display function so that you can tell how many hours are left until sunset and what time the sun is directly overhead.
- Alt-azimuth display function so that you can know the altitude and the azimuth of the sun and the major stars on the celestial sphere. (The horizontal line on the dial is corrected for an atmospheric aberration of about 0.6°).
- Sidereal time display that makes it easy to know where the constellations are located.
- Twilight identifier function that helps to judge the darkness of the sky for convenience in astronomical observation.

2. Notes on use

We have designed two kinds of constellation watches. Make sure you know which type you own and follow the instructions for proper use.

Display whole Skies at 50° North-Latitude (Cal. 4390)

This displays almost the entire celestial sphere visible at 50° north-latitude, and is very handy for viewing the entire night-time sky.

Displays about 97 percent of the sky visible at 50° north-latitude.

(Range of display is $-40.6^\circ \sim +74.3^\circ$ declination, about 640 fixed stars and 28 variable stars)

*The celestial sphere at the center of the rotating constellation dial is not displayed because that's where the hands are attached.

Display Southern Skies at 35° North-Latitude (Cal. 4380)

Displays the celestial sphere from the zenith at 35° North-Latitude along the south meridian. Offers very little distortion in the positions of the southern skies constellations. The size of each constellation is averaged and enlarged so that it is easy to see. This is an excellent watch for observing the southern skies. It displays about 77 percent of the celestial sphere visible at 35° north-latitude.

(Range of display is from $-55.6^\circ \sim +35^\circ$ declination. Displays about 590 fixed stars and 18 variables.)

3. Range of latitudes for recommended use

The constellation watch can be used in the following range of latitudes and will provide a handy guide to the positions of stars at those latitudes.

- Whole sky display at 50° north-latitude at north latitudes of 42.5° ~ 57.5°
- Display of skies from north latitude 35° south at north latitudes of 27.5° ~ 42.5°

*To know the position of stars more accurately.

Adjust the north-south position of the horizon to compensate for differences in latitude. For example, if you were using the watch that views the whole sky at 50° north latitude and your observation point is at 42.5° north-latitude, you would read the north horizon indicator as 7.5° higher and the southern horizon indicator as 7.5° lower (7.5° higher if you were using the north latitude 35° southern skies display watch). There will be almost no change in the position of the eastern and western horizon lines.

4. OPERATING THE WATCH

1. Main components

Display whole Skies at 50° North-Latitude (Cal. 4390)

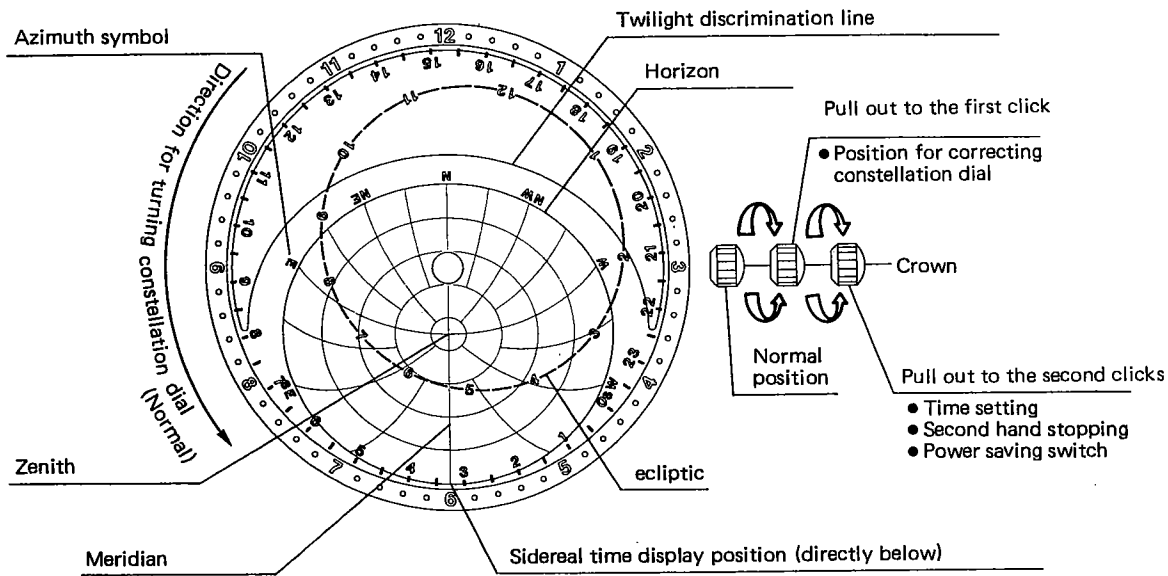

Display Southern Skies at 35° North-Latitude (Cal. 4380)

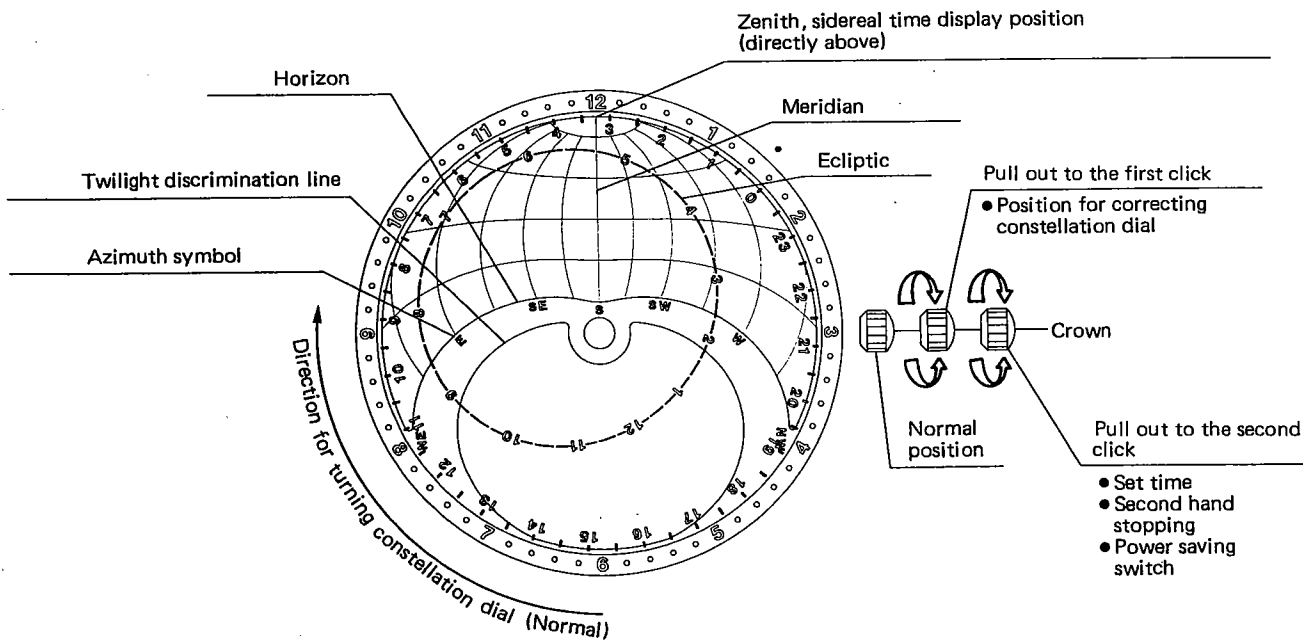

The ecliptic is the apparent path that the sun follows through the skies. The number is for the number of the month and the position of the sun is indicated for the 1st, 11th and 21st of each month (12 noon U.T. mean year).

2. Setting the time and the constellation dial (for Display whole Skies at 50° North-Latitude)

..... Setting by Sunrise Time

The description given here is for the Display Whole Skies at 50° North-Latitude watch. To make the same adjustments on the Display Southern Skies at 35° North-Latitude watch see the items in brackets [].

Use of this method makes adjusting the time and the constellation dial position easy.

- Check the newspaper to find the time of today's sunrise.
- Then set the hour and minute hand to the time of sunrise.
 - a) Pull the crown out to the second click position.
 - b) Turn the crown and set the hour and minute hands to the sunrise time.
- Then set the constellation dial to the sunrise time.
 - c) Push the crown all the way in. Then pull it out to the first click position.
 - d) Turn the crown to turn the constellation dial clockwise [counter clockwise for the Display Southern Skies at 35° North-Latitude watch]. Bring the solar mean position for that particular day (on the ecliptic on the constellation dial) so that it overlaps the dial's east horizon line.

If today were August 18 (8/18), for example, we would look at the solar mean position (gap in broken line) on the constellation dial's ecliptic between August 11 (8/11) and August 21 (8/21). Adjust the constellation dial as shown in the figure below.

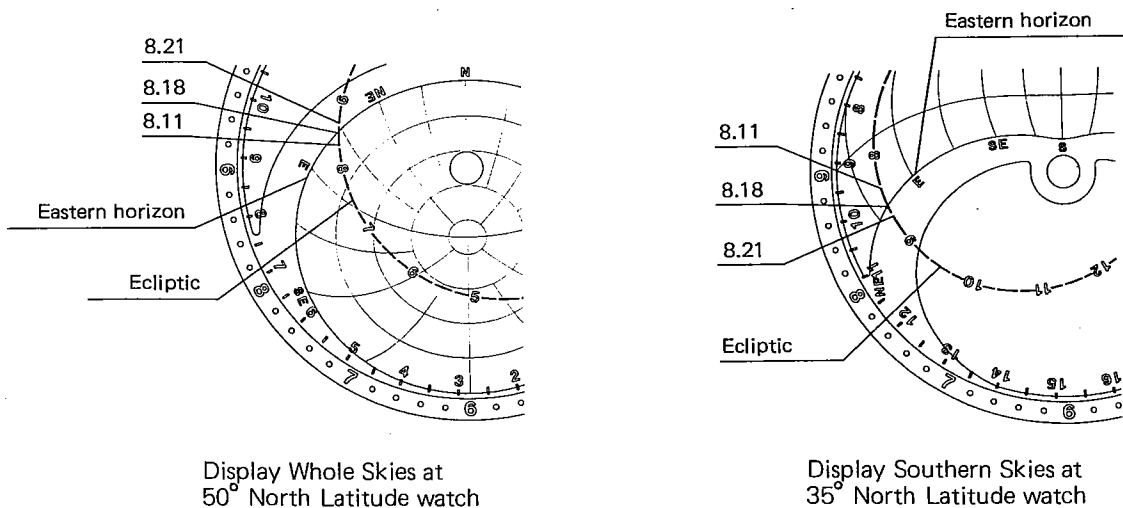

- e) When the second hand reaches 0 seconds, pull the crown out to the second click position.
- f) Turn the crown counter-clockwise. Bring the minute hand back to 20 or 30 minutes before the sunrise time. Turn the crown to the clockwise to again move the hand forward. When the sunrise time is indicated, make sure that the solar mean position for today on the constellation dial's ecliptic is on the east horizon line of the dial.

If there is a gap between the watch and the actual situation, repeat steps c) to f) to readjust the the watch.

- For the final step, set the hour and minute hand and the constellation dial to the present time and then start the watch.
- g) Turn the crown and set the hour and minute hand to the correct time making sure of whether it is AM or PM.

*If the latitude of the observation point is anything but 50° north-latitude, [or 35° north-latitude if the watch is the Display Southern Skies at 35° North-Latitude watch] there may be some margin of error in sidereal time. If you want to set the time more accurately, we suggest the method of setting the constellation dial as in "1. Sidereal Time" in (Actively Using the Constellation Watch).

5. HOW TO READ THE CONSTELLATION WATCH

1. The celestial sphere and the dial

*The dial corresponds to the celestial sphere as the diagram below shows. The dark area is the area above the horizon (the area that is actually visible) and indicates the celestial sphere that is displayed on the dial.

Display whole Sky at 50° North-Latitude (Cal. 4390)

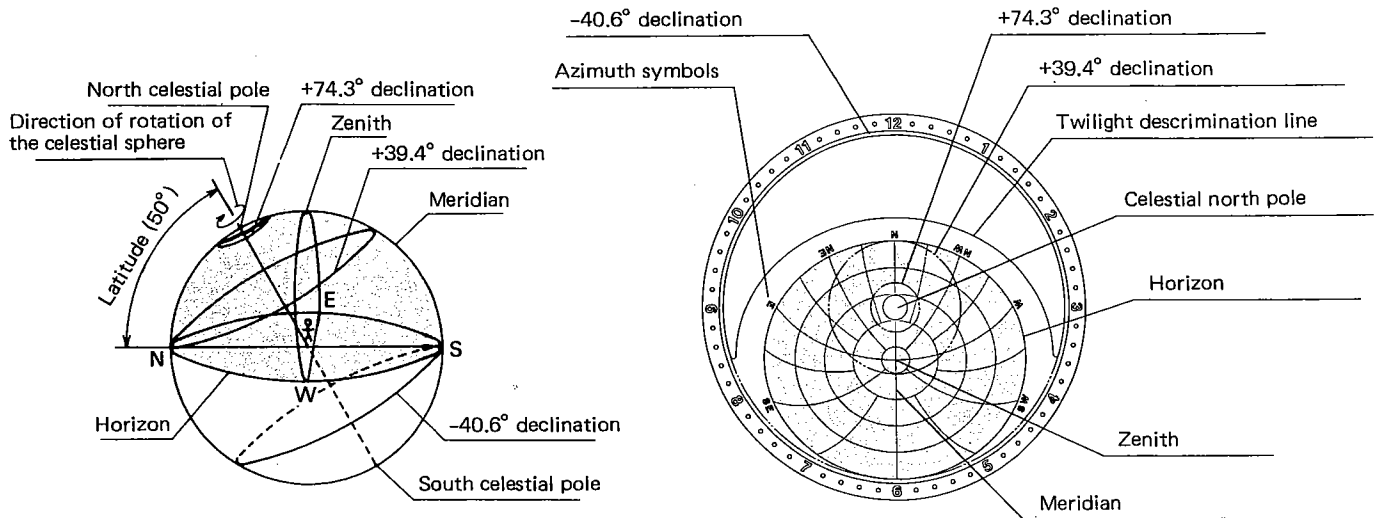

Display Southern Sky at 35° North-Latitude (Cal. 4380)

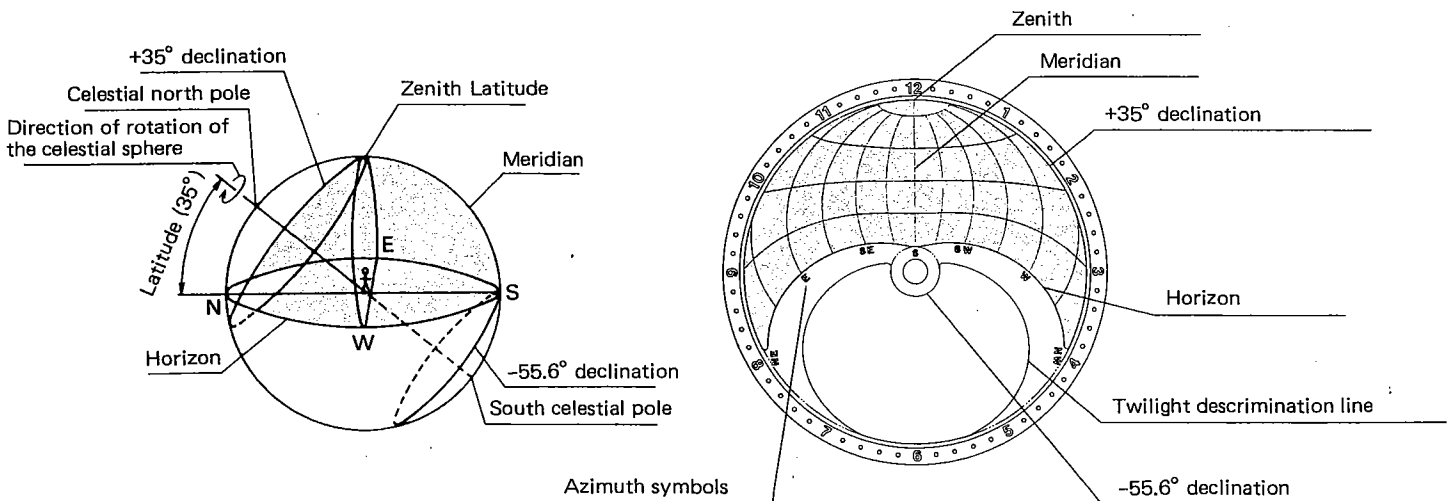

Watch for viewing the whole skies at 50° north-latitude (Cal. 4390)

Diagram showing the constellation dial

- Major constellations and stars with a luminosity of 1.6 visual magnitude or brighter

*For design and layout reasons there will be some difference in the position and size of the actual constellations and the position and size of the constellation pictures (12 zodiac constellations) as printed on the constellation dial.

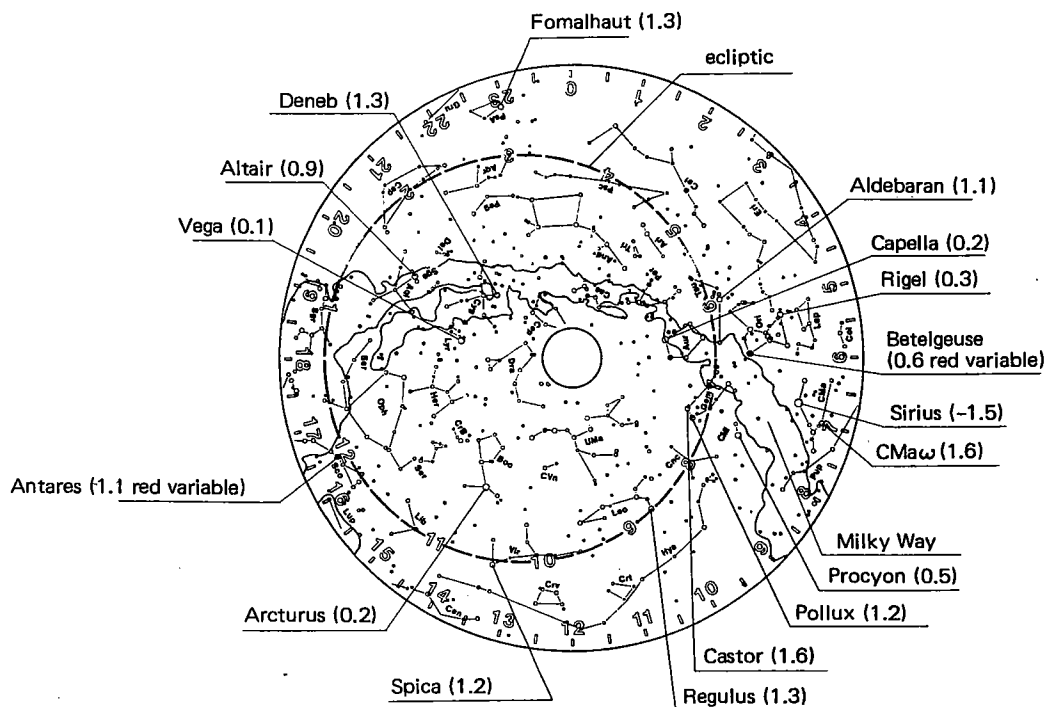

Watch for viewing the southern skies at 35° north-latitude (Cal. 4380)

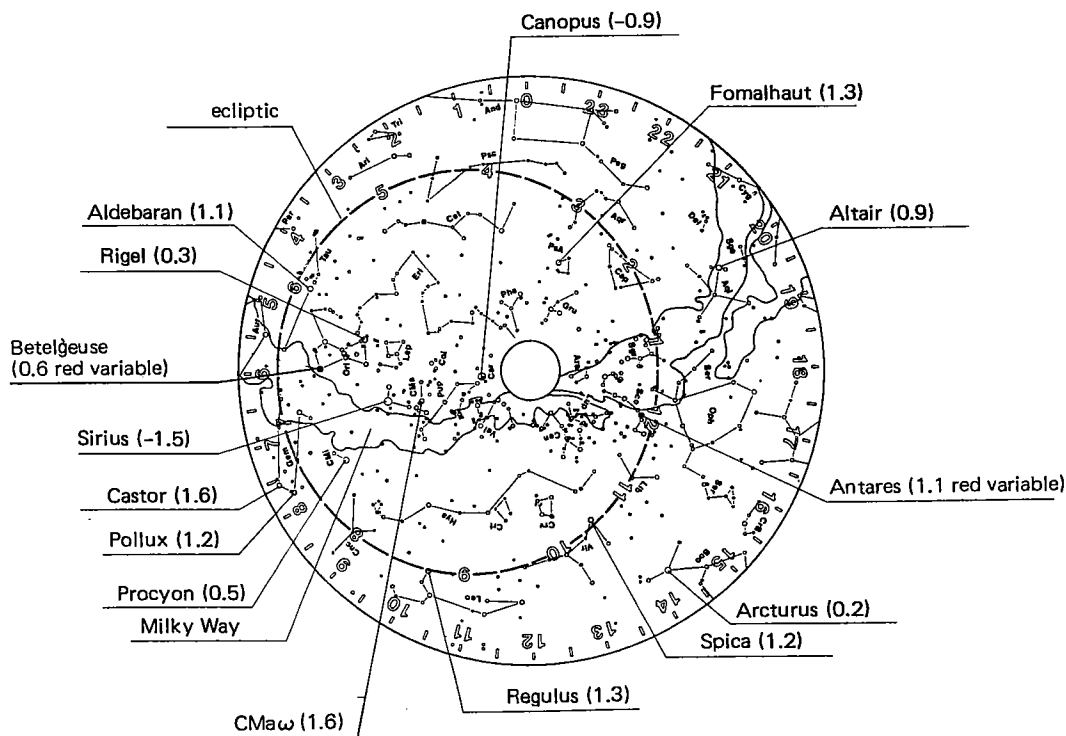

Actively using the Constellation Watch

These pages were written so that you can get the best from your constellation watch. Through an understanding of all its functions, the watch will give you maximum enjoyment.

— Contents —

1. Using sidereal time to set the constellation dial

Through the use of this method you can more accurately set the time and the constellation dial (sidereal time) than would be the case by just using the settings in ■4. of the Instruction Manual on **"Setting by Sunrise Time."**

2. The various functions and how to use them

This section describes the various functions that can be used and how to use them, such as the use of the constellation dial for the observation of astronomical bodies. Read this description thoroughly so that you can use the constellation watch in as many ways as possible.

**1. Using Sidereal time to set the constellation dial
(watch for displaying the whole sky at 50° north-latitude)**

This description is of the watch for displaying the whole sky at 50° north-latitude. Items of the watch for displaying the southern skies at 35° north-latitude are in brackets [].

Use the sidereal time table (Table 1), the table of annual compensation values (Table 2) and the table of standard time longitude correction values (Table 3).

- First check the difference in sidereal time between standard time longitude and observation point longitude.

* The difference between sidereal time per degree of longitude is 4 minutes. If the observation point is to the east of the standard time line of longitude, then the difference is advance (+), if the observation point is to the west then late (-) the time.

- Pull the crown out to the second click position.
- (1) Find the difference between sidereal time at the standard time longitude line and sidereal time at the observation point.
(2) Subtract the value in (1) from 12 noon and set the minute and hour hands to that time.

Example) If the observation point is 5° to the east of the standard time longitude line (i.e., the observation point where there is a +20 minute difference with sidereal time) set the hour and minute hands to 12:00 – 20 minutes, 11:40, because the astronomical bodies will be in meridian transit about 20 minutes ahead of the standard time longitude line.

- Pull the crown to the first click position.
- To derive sidereal time more precisely than in b) above.
1) sidereal time (Table 1, page 13. 14) + 2) value of yearly correction (Table 2, page 15) + 3) value of correction for standard time longitude (Table 3, page 15) = sidereal time

*Use values for 1), 2) and 3) that are taken from the tables that have that same number. Turn the crown to turn the constellation dial clockwise. [counterclockwise on the watch for displaying the southern skies at 35° north-latitude] and the constellation dial's graduations of right ascension, which match the derived sidereal time, are in the same direction as the dial's meridian nadir [zenith on the watch for displaying the southern skies at 35° north-latitude].

If, for example, the standard time longitude at the observation point is 0° on 24 October, 1987, set the constellation dial to a sidereal time of 14h 11m + (-1m) + 0m = 14h 10m as indicated in the chart below.

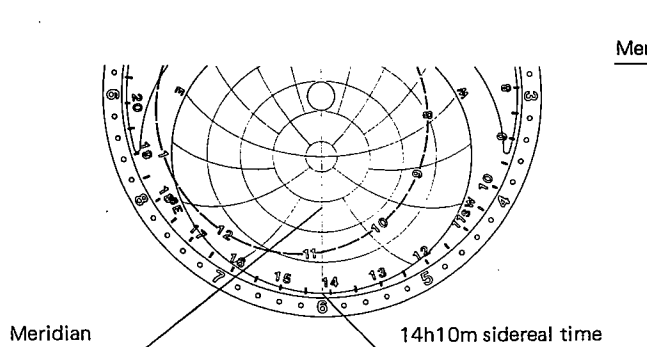

Display Whole Skies at 50° North Latitude watch

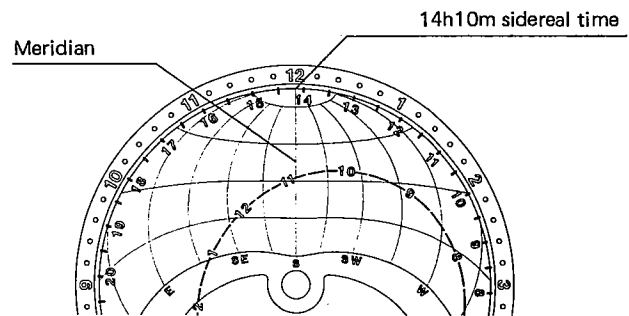

Display Southern Skies at 35° North Latitude watch

- e) When the second hand is on 0, pull the crown out to the second click position.
- f) Turn the crown counterclockwise so that the minute hand moves counterclockwise 20 to 30 minutes from the time set in b). Then, turn the crown clockwise to move the hand ahead to the time set in b). When time indicated is that set in b) check to make sure that the constellation dial's graduation of right ascension that match the sidereal time derived in d) are in the same direction as the dial's meridian nadir [zenith on the watch for displaying the southern skies at 35° north-latitude].
If there is still a noticeable difference, reset going through steps c) to f).
- g) Turn the crown and set the hour and minute hand to the correct time making sure whether it is AM or PM. Move the minute hand 4 to 5 minutes ahead of the correct position and then return it to the correct position.
- * Using the annual compensation values table and the standard time longitude compensation value table at any other time than setting the sidereal time accurately is unnecessary.

[Explanation of astronomical terminology]

- Right ascension, declination, meridian transit and sidereal time

Longitude and latitude which use the earth's axis as a reference point are the means by which a position on the surface of the earth is determined. Analogous to longitude and latitude for the celestial sphere are right ascension and declination which are used to determine the position of astronomical bodies in reference to the earth's axis.

Declination is equivalent to latitude and right ascension is equivalent to longitude so that the celestial north pole, equator and south pole are each located at $+90^\circ$, 0° and -90° . Using the vernal equinox, the point on the equator that the sun passes as it moves from south to north, as the point of origin, and moving to the left as seen with the celestial north pole at the top and the south pole at the bottom, right ascension is measured from 0h to 23h 59m 59s

If an astronomical body were to move along the meridian from the celestial north pole through the zenith to the south pole this would be a meridian transit. Sidereal time is a time system which is based on the right ascension of a body in meridian transit.

If the latitude is the same and the sidereal time is the same, then the position of a constellation on the celestial sphere is the same, so the sidereal time is a very convenient tool for finding the position of a constellation. In astronomical measurements this is as important a time system as mean solar time.

- Relation between mean solar time and sidereal time from one tropical year (about 365.2422 days at the vernal equinox) moves in the same direction as the earth is revolving around the sun, sidereal time advances one day to mean solar time in one tropical year. So there is about a 3 minute and 56.6 second advance per day. Consequently, the sidereal day is shorter than the mean solar day by that amount and is about 23 hours 56 minutes 4.1 seconds (in mean solar time).

Sidereal time at longitude 0° Average year 12 hours U.T. (universal time)

*In areas where summertime is in force, deduct one hour from the values in the sidereal time table.

Table 1

date	January	February	March	April	May	June
1	18h 43m	20h 45m	22h 36m	0h 39m	2h 37m	4h 39m
2	18h 47m	20h 49m	22h 40m	0h 43m	2h 41m	4h 43m
3	18h 51m	20h 53m	22h 44m	0h 47m	2h 45m	4h 47m
4	18h 55m	20h 57m	22h 48m	0h 51m	2h 49m	4h 51m
5	18h 59m	21h 01m	22h 52m	0h 54m	2h 53m	4h 55m
6	19h 03m	21h 05m	22h 56m	0h 58m	2h 57m	4h 59m
7	19h 07m	21h 09m	23h 00m	1h 02m	3h 01m	5h 03m
8	19h 11m	21h 13m	23h 04m	1h 06m	3h 05m	5h 07m
9	19h 14m	21h 17m	23h 08m	1h 10m	3h 09m	5h 11m
10	19h 18m	21h 21m	23h 12m	1h 14m	3h 12m	5h 15m
11	19h 22m	21h 25m	23h 16m	1h 18m	3h 16m	5h 19m
12	19h 26m	21h 29m	23h 20m	1h 22m	3h 20m	5h 23m
13	19h 30m	21h 32m	23h 24m	1h 26m	3h 24m	5h 27m
14	19h 34m	21h 36m	23h 28m	1h 30m	3h 28m	5h 30m
15	19h 38m	21h 40m	23h 32m	1h 34m	3h 32m	5h 34m
16	19h 42m	21h 44m	23h 36m	1h 38m	3h 36m	5h 38m
17	19h 46m	21h 48m	23h 40m	1h 42m	3h 40m	5h 42m
18	19h 50m	21h 52m	23h 44m	1h 46m	3h 44m	5h 46m
19	19h 54m	21h 56m	23h 47m	1h 50m	3h 48m	5h 50m
20	19h 58m	22h 00m	23h 51m	1h 54m	3h 52m	5h 54m
21	20h 02m	22h 04m	23h 55m	1h 58m	3h 56m	5h 58m
22	20h 06m	22h 08m	23h 59m	2h 02m	4h 00m	6h 02m
23	20h 10m	22h 12m	0h 03m	2h 05m	4h 04m	6h 06m
24	20h 14m	22h 16m	0h 07m	2h 09m	4h 08m	6h 10m
25	20h 18m	22h 20m	0h 11m	2h 13m	4h 12m	6h 14m
26	20h 21m	22h 24m	0h 15m	2h 17m	4h 16m	6h 18m
27	20h 25m	22h 28m	0h 19m	2h 21m	4h 19m	6h 22m
28	20h 29m	22h 32m	0h 23m	2h 25m	4h 23m	6h 26m
29	20h 33m	22h 36m	0h 27m	2h 29m	4h 27m	6h 30m
30	20h 37m		0h 31m	2h 33m	4h 31m	6h 34m
31	20h 41m		0h 35m		4h 35m	

date	July	August	September	October	November	December
1	6h 37m	8h 40m	10h 42m	12h 40m	14h 42m	16h 41m
2	6h 41m	8h 44m	10h 46m	12h 44m	14h 46m	16h 45m
3	6h 45m	8h 48m	10h 50m	12h 48m	14h 50m	16h 49m
4	6h 49m	8h 52m	10h 54m	12h 52m	14h 54m	16h 53m
5	6h 53m	8h 55m	10h 58m	12h 56m	14h 58m	16h 56m
6	6h 57m	8h 59m	11h 02m	13h 00m	15h 02m	17h 00m
7	7h 01m	9h 03m	11h 06m	13h 04m	15h 06m	17h 04m
8	7h 05m	9h 07m	11h 10m	13h 08m	15h 10m	17h 08m
9	7h 09m	9h 11m	11h 13m	13h 12m	15h 14m	17h 12m
10	7h 13m	9h 15m	11h 17m	13h 16m	15h 18m	17h 16m
11	7h 17m	9h 19m	11h 21m	13h 20m	15h 22m	17h 20m
12	7h 21m	9h 23m	11h 25m	13h 24m	15h 26m	17h 24m
13	7h 25m	9h 27m	11h 29m	13h 28m	15h 30m	17h 28m
14	7h 29m	9h 31m	11h 33m	13h 31m	15h 34m	17h 32m
15	7h 33m	9h 35m	11h 37m	13h 35m	15h 38m	17h 36m
16	7h 37m	9h 39m	11h 41m	13h 39m	15h 42m	17h 40m
17	7h 41m	9h 43m	11h 45m	13h 43m	15h 46m	17h 44m
18	7h 45m	9h 47m	11h 49m	13h 47m	15h 49m	17h 48m
19	7h 48m	9h 51m	11h 53m	13h 51m	15h 53m	17h 52m
20	7h 52m	9h 55m	11h 57m	13h 55m	15h 57m	17h 56m
21	7h 56m	9h 59m	12h 01m	13h 59m	16h 01m	18h 00m
22	8h 00m	10h 02m	12h 05m	14h 03m	16h 05m	18h 03m
23	8h 04m	10h 06m	12h 09m	14h 07m	16h 09m	18h 07m
24	8h 08m	10h 10m	12h 13m	14h 11m	16h 13m	18h 11m
25	8h 12m	10h 14m	12h 17m	14h 15m	16h 17m	18h 15m
26	8h 16m	10h 18m	12h 20m	14h 19m	16h 21m	18h 19m
27	8h 20m	10h 22m	12h 24m	14h 23m	16h 25m	18h 23m
28	8h 24m	10h 26m	12h 28m	14h 27m	16h 29m	18h 27m
29	8h 28m	10h 30m	12h 32m	14h 31m	16h 33m	18h 31m
30	8h 32m	10h 34m	12h 36m	14h 35m	16h 37m	18h 35m
31	8 36m	10h 38m		14h 38m		18h 39m

Sidereal Time Annual Compensation Values

Table 2

Year and Month	Year and Month	Compensation (minutes)
1986.3	~ 1987.2	0
1987.3	~ 1988.2	-1
1988.3	~ 1989.2	+2
1989.3	~ 1990.2	+1
1990.3	~ 1991.2	0
1991.3	~ 1992.2	-1
1992.3	~ 1993.2	+2
1993.3	~ 1994.2	+1
1994.3	~ 1995.2	0
1995.3	~ 1996.2	-1
1996.3	~ 1997.2	+2
1997.3	~ 1998.2	+1
1998.3	~ 1999.2	0
1999.3	~ 2000.2	-1
2000.3	~ 2001.2	+2

Sidereal Time Standard Time Longitude Compensation Values

Table 3

Standard time longitude	Time difference with Greenwich	Compensation value (minutes)
East longitude 142.5° and to the east	+9h 30m ~ +13h 00m	-2
East longitude 52.5° ~ 135°	+3h 30m ~ +9h 00m	-1
West longitude 45° ~ East longitude 45°	-3h 00m ~ +3h 00m	0
West longitude 135° ~ 52.5°	-9h 00m ~ -3h 30m	+1
West longitude 165° ~ 150°	-11h 00m ~ -10h 00m	+2

2. Various functions and how to use them (for the watch with the whole sky at 50° north latitude)

This explanation is for the watch with the whole sky at 50° north latitude. Notes for the watch with the southern skies at 35° north latitude are in brackets [].

1) Constellation quick read function

Set the watch for correcting the constellation dial. Set the crown to the first click position. Place the solar mean position of the month and day that you want to know over the meridian on the dial. Rotate the constellation dial from 12 noon to the left [right for the watch for viewing the southern skies at 35° north latitude] by the amount of lapsed time that you want to know. If you then advance the sidereal time you can find out what the general constellation position is.

If for example you want to know the position of a constellation at 22:00 (10 p.m.) on December 11, first set the crown to the first click position. Then place the constellation dials at the ecliptic solar mean position (breaks in the dotted line for the ecliptic) for December 11 on the meridian of the dial. Then turn the constellation dial clockwise [counterclockwise for the watch with the southern skies at 35° north latitude] 10 hours 22:00 – 12:00 from. Then by advancing the sidereal time you can obtain the general constellation position.

- * For more accurate positioning, instead of twelve hours, use the solar meridian time for the month and day that you want to know. Set the crown to the first click position. Then move the solar mean position of the month and day that you want to know so that it is on the meridian on the dial and in the solar meridian transit state. Then move the constellation dial to the left by the amount of lapsed time up to the solar meridian transit time that you want to know and then read the sidereal time to find the constellation position. Meridian transit time can be obtained by adding sunset and sunrise time together and dividing by two. The difference in length between sidereal time and mean solar time is less than two minutes in 12 hours, so there is no need to adjust for the difference when using the quick-read constellation dial.
- After checking this function, set the constellation's position (sidereal time) to its present position. Leave the crown in the first click out position and turn it clockwise [counterclockwise for the watch with the southern skies at 35° north latitude]. Then turn the constellation dial clockwise [counterclockwise for the watch for the southern skies at 35° north latitude] so that the right ascension graduations for the meridian nadir [zenith for the watch for the southern skies at 35° north latitude] are at present sidereal time. Push the crown all the way in the way in to the normal position.

2) Solar mean position display function

Look at the solar mean positions for the 1st, 11th and 21st of each month that are written on the ecliptic on the constellation dial. This is how you read the solar mean positions on the celestial sphere for any particular day. At 50° north latitude [35° north latitude for the watch for the southern skies at 35° north latitude] the time for sunrise and sunset is almost exactly when the solar mean position is on the horizon. The solar mean position in solar meridian transit time has no relation to latitude and is almost exactly on the meridian line of the dial.

3) Remaining hours of sunlight and sunlight hours display function.

Set the crown to the first click position (to correct the constellation dial). Reading the difference in time between present sidereal time at daytime and sidereal time at sunset gives the hours of sunlight remaining. Reading the difference in time between sunrise and sunset allows you to know how many hours of sunlight there are for that particular day. (Time will deviate somewhat the farther in latitude the observation site is from 50° north [from 35° north for the watch for the southern skies from 35° north latitude]). The actual hours of sunlight will also be shortened by obstacles to the sunlight such as mountains or buildings, but will lengthen if one climbs a high mountain). You can also use the same operation to read the time until the constellation that you want to see appears and consecutive time of twilight which will be explained below.

* After checking this function for setting the constellation's position (sidereal time) to its present position.

4) Azimuth and altitude display functions

On the dial are inscribed isogonic lines azimuth symbols and almucantar lines (every 20°). Matching these to a fixed star on the constellation dial or to the solar mean position (in the daytime) will allow you to know the azimuth and altitude of that fixed star or solar mean position.

* There will be differences in azimuth and altitude the farther in latitude the point of observation is from 50° north latitude [or 35° north latitude with the watch for the southern skies at 35° north latitude].

5) Sidereal time display function

Sidereal time can be known by reading the right ascension graduations on the constellation dial in the direction of the nadir [zenith for the watch for viewing the southern skies at 35° north latitude] of the meridian on the dial.

6) Twilight identification function

Because of the reflection and diffraction of light by the earth's atmosphere, the sky will not be completely dark for some time after the sun sets or before the sun rises. That state of light is known as twilight, and is not suitable for the observation of astronomical objects. This watch will indicate the celestial sphere 18° below the horizon (the twilight discrimination line) in the upper side of the dial [downside of the dial in the watch for the southern skies at 35° north latitude]. If today's solar position is in it, it shows that twilight caused by the sun is not occurring.

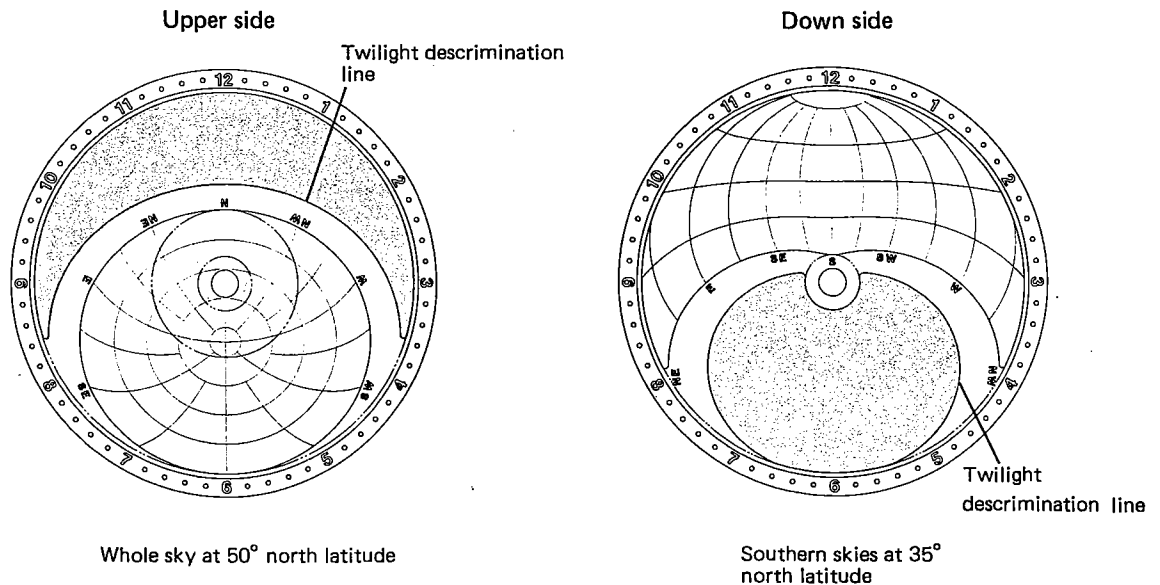

■4. DISASSEMBLY, ASSEMBLY AND LUBRICATION OF THE MOVEMENT

Disassembling procedure : ① → ②⑦

Assembling procedure : ②⑦ → ①

● Lubrication markings

- Ⓐ A lube
- Ⓥ V lube
- Ⓕ F lube
- ∞ CH-1

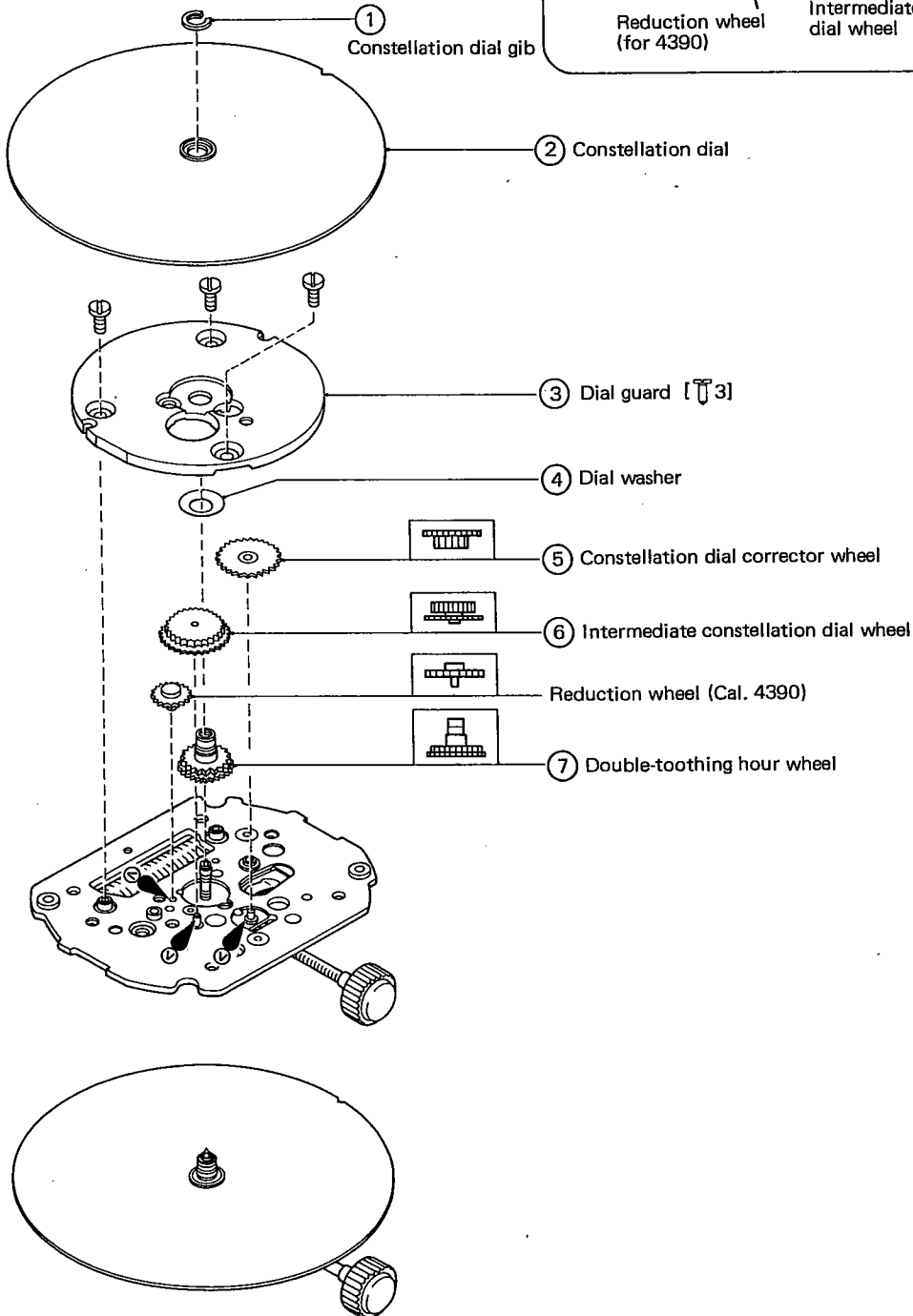
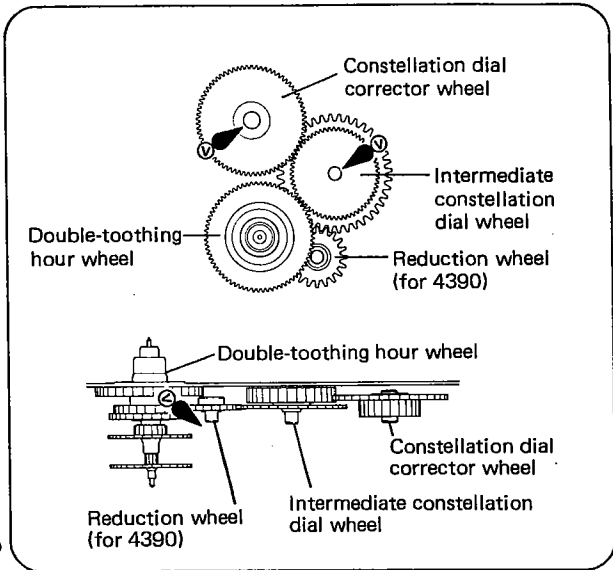

Although there are some differences in the shape of the plate complete and other parts as regards calibers, the disassembling and assembling procedures are the same.

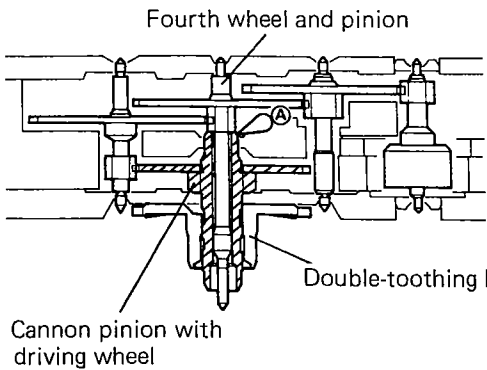

Apply A lube to the under surface of the pinion of the fourth wheel and pinion. (To prevent wear caused by friction between the cannon pinion and the driving wheel.)

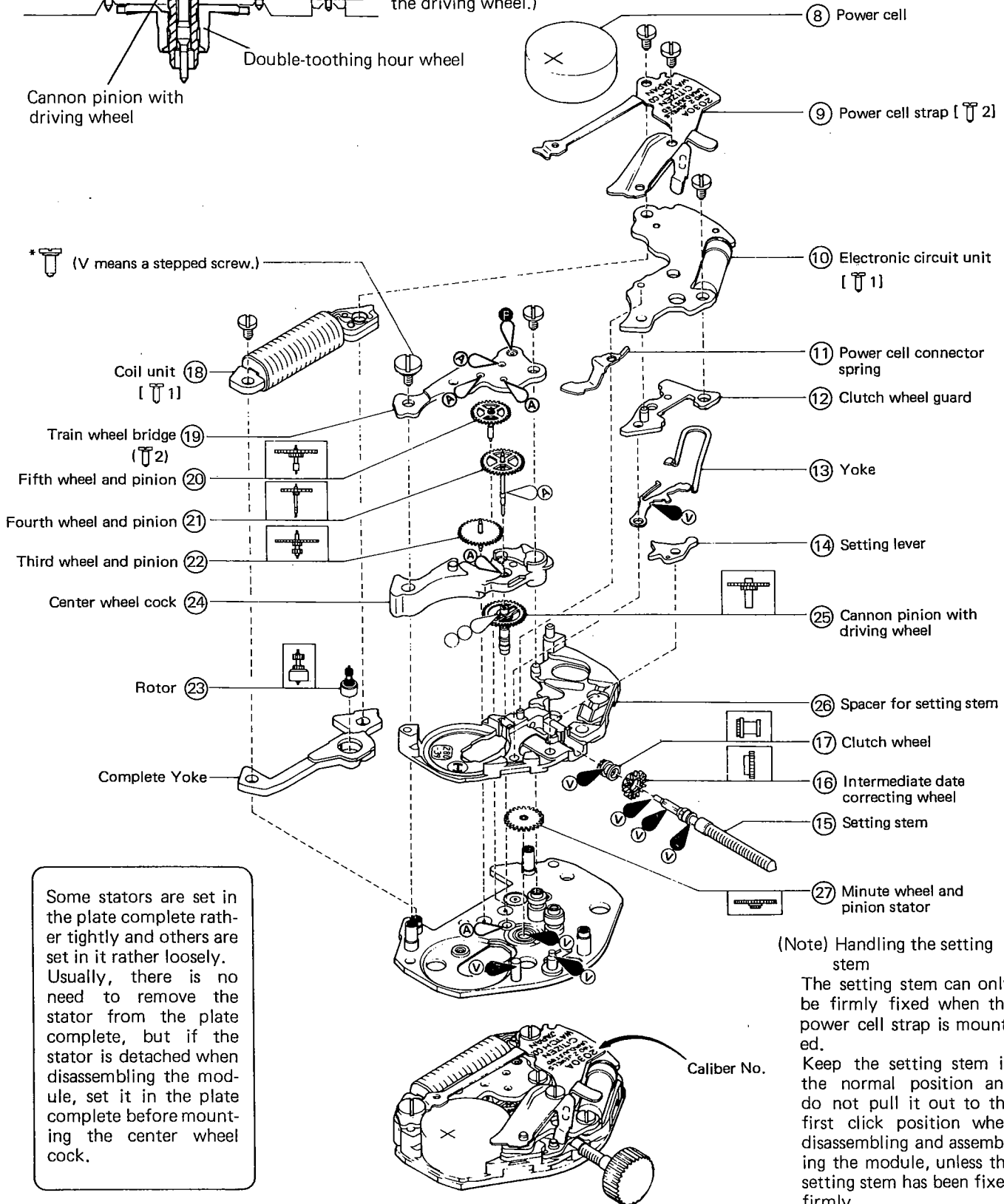

Some stators are set in the plate complete rather tightly and others are set in it rather loosely. Usually, there is no need to remove the stator from the plate complete, but if the stator is detached when disassembling the module, set it in the plate complete before mounting the center wheel cock.

(Note) Handling the setting stem
 The setting stem can only be firmly fixed when the power cell strap is mounted.
 Keep the setting stem in the normal position and do not pull it out to the first click position when disassembling and assembling the module, unless the setting stem has been fixed firmly.

■5. TROUBLESHOOTING AND ADJUSTMENT

- * 1. The Cal. 4380A-01 and the Cal. 4390-01 are based on the Cal. 20 design.
Repairs and adjustments should be made using the methods for the Cal. 20 series.
(Current values for Cal. 4380A/4390A are under $1.7 \mu\text{A}$)