

***TECHNICAL
INFORMATION***

CITIZEN QUARTZ

Cal. No. 39※※

 **CITIZEN**

■1. OUTLINE

Cal Nos. 3910E-06 and 3920E-07, slim-type analog watches for men, were developed with the objective of expanding the high-grade product range.

■2. FEATURES

- 1) These compact and slim men's electronic wrist watches employ a quartz crystal oscillator. (Cal. 3910 incorporates the world's thinnest movement with a date display function.)

Movement size,

[Cal. 3910] 18.0 mm x 18.0 mm x 22.0 mm ϕ
Thickness 1.70 mm (measured when the power cell section is included.)

[Cal. 3920] 18.0 mm x 18.0 mm x 22.0 mm ϕ
Thickness 1.4 mm (measured when the power cell section is included.)

- 2) Watch design rich in variation
These watch designs are easily varied because of the thin, compactness of their movement parts.
- 3) Two year power cell life guaranteed
The power cells mounted in these watches are very small silver cells. The service life of these cells lasts as long as 2 years because each watch is incorporated with an IC with low current consumption.

■3. SPECIFICATIONS

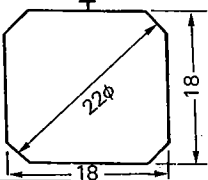
Caliber No.		3910E-06	3920E-07
Type		Analog quartz watch (without a center second hand)	←
Module size (mm)		 <p>Thickness (t): 1.7 mm (measured when the power cell section is included)</p>	Thickness: 1.4 mm (measured when the power cell section is included)
Accuracy		±15 sec./month at normal temp.	←
Oscillation		32,768Hz	←
Integrated circuit		C/MOS-LSI (1 unit)	←
Effective temp. range		-10°C ~ +60°C: (14°F ~ 140°F)	←
Converter		Bipolar step motor	←
Adjustment of time rate		DFC (without adjustment terminals)	←
Measurement of time rate		10 seconds	←
Additional functions	Date (with quick setting device)	Yes (O)	No (X)
	Day (with quick setting device)	No (X)	←
	Days of the week bilingual display selection	No (X)	←
	Second hand stopping device	No (X)*1	←
	Power saving switch	Yes (O)	←
	Power cell life indicator	No (X)	←
Power cell	Hand movement	10-second stepping movement	←
	Part No.	280-66	←
	Cell code	SR712SW (Ag ₂ O/NaOH)	←
	Size (mm)	7.9 ϕ x 1.3t	←
	Voltage	1.55V	←
	Capacity	10mAH	←
	Life time	Approx. 2 years	←
Current consumption		Under 0.5 μ A	←
Coil resistance		1.6k Ω ~ 2.1k Ω	←
Remarks		*1. The hand-stopping device is used for the hour and minute hands, not for the second hand.	←

■4. HANDLING INSTRUCTIONS

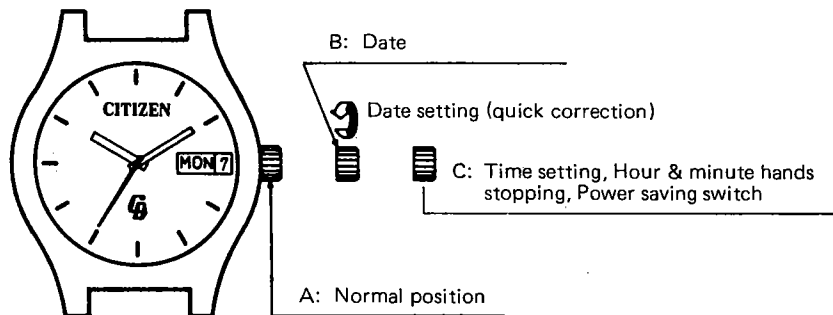

[Regarding Cal. 3910]

Pull the crown out to the second clicking position (a state in which power is saved) and set the time in the same manner as in the normal analog model with the date display function.

Push the crown back to the first clicking position to set the date. Be sure to push the crown back to its normal position after setting the time and date.

(Note)

The date display is designed to change at approx. 3:00 A.M.

Do not carry out quick correction of dates between 9:00 PM and 3:00 AM.

Quick correction should not be done during this period. If it is carried out during this period, the date display may not change the following day.

[Regarding Cal. 3920]

Pull the crown out to the first clicking position (a state in which power is saved) and set the time in the same manner as in the normal analog model. Push the crown back into its normal position after setting the time, and start the watch.

Cal. 3920 has not been provided with a date display function.

■5. CONSTRUCTION OF MOVEMENT

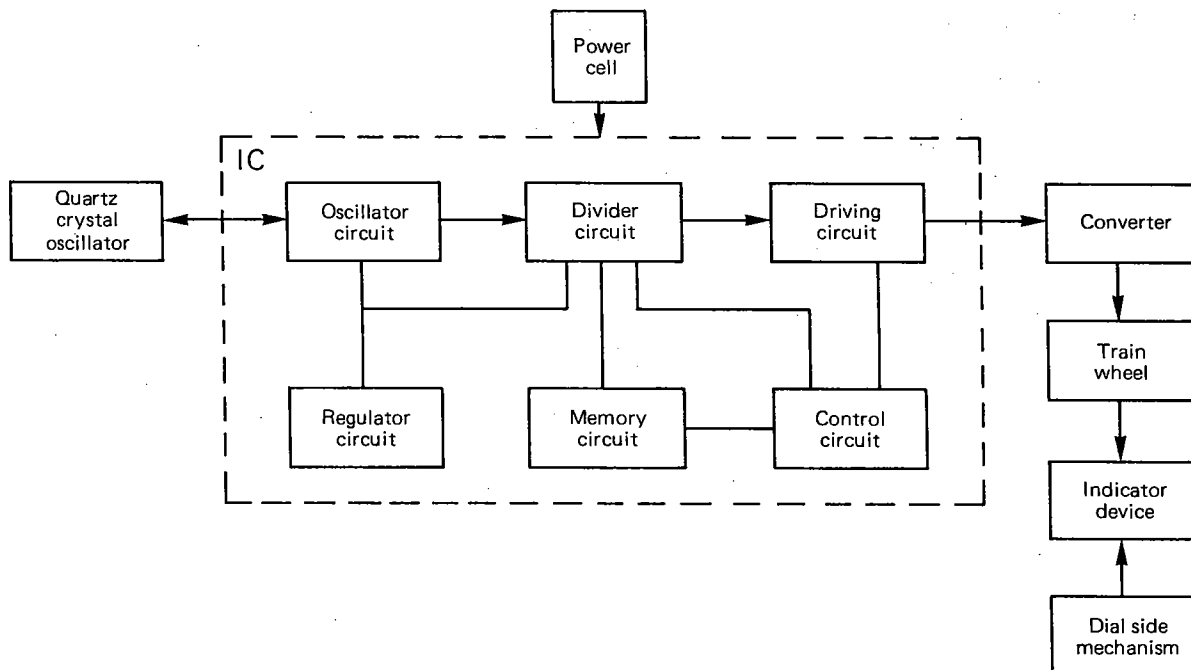

- The regulator circuit changes variable outside voltage into constant voltage by applying it to the oscillator circuit and subsequent circuits.

- In these two Calibers, 3910 and 3920, the frequency rate of the quartz oscillator is adjusted by the DFC (Digital Frequency Control). This frequency adjustment is carried out in the memory and control circuits at the factory. Therefore, this procedure is not required at the market level.

6. NOTES ON DISASSEMBLY AND ASSEMBLY/COMPARISON WITH OTHER CAL. NOS.

1) Handling of the hour and minute hands

Remove the hour and minute hands with a hand-pulling out instrument for Cal. 7900. Be careful not to bend the hands or scratch the dial when removing them.

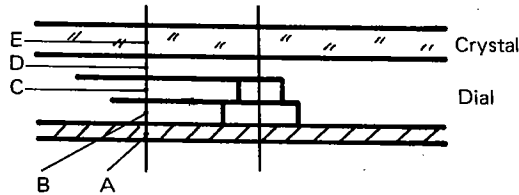

The thickness of the hand is 100 μ . When mounting the hands, make sure that they are in the right position with no gap with the dial or the crystal.

(Comparative table of hand-spacing)

	CAL 2720	CAL 3910
A	300 μ	300 μ
B	300 μ	300 μ
C	250 μ	200 μ
D	350 μ	300 μ
E	600 μ	500 μ

2) Removal and mounting of the setting stem

- Remove or mount the setting stem with it pushed into its normal position.
- The clutch wheel of CAL 3910 is not symmetrical because of the quick correction claw it is incorporated with. Do not forcibly remove or mount the setting stem as the clutch wheel may tumble down.

3) Clutch wheel/Slip torque of the quick correction claw

When a heavy load is applied to the quick correction claw (which is fitted in the clutch wheel), the quick correction claw will cause a slip preventing the date dial and the claw itself from being damaged. As a result, quick correction will not be possible. Be careful that the parts are not deformed and that foreign matter does not get in the parts.

Also, pay attention to where and how much lubricant should be applied. (When an applied load is more than 6 gcm, the date dial may be damaged and the quick correction claw may be deformed.)

4) Date-resetting position

After the calendar is corrected, the watch reads 3 o'clock a.m. Therefore, please be careful when mounting the hands.

5) Power cell insulator (red)

It is a folding-type double insulator.

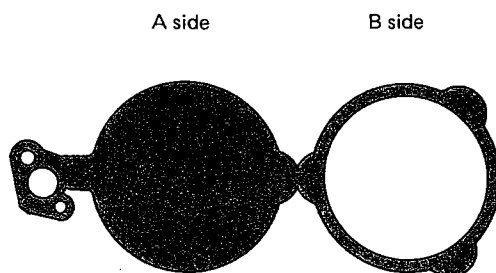

The A side insulates the power cell from the plate, and the B side, the + terminal of the power cell, from the power cell connector spring.

When replacing the power cell, make sure that the portions projecting from the circumference of the B side fit in their respective grooves on the plate.

6) Notes on mounting the train wheel.

Firmly tighten one of the coil screws before mounting the train wheel, the stator will be stable and make it easy to mount the train wheel.

7) Comparison of the movement's thickness

(Cal. No.)	(Specifications)	(Total thickness of the module)	(Thickness of the module)
CAL 7903	Without a center second hand Plain	1.96 t	1.11 t
CAL 2720	"	2.85 t	1.90 t
CAL 2760	With date display	3.23 t	2.28 t
CAL 3910	"	2.50 t	1.70 t
CAL 3920	Plain	2.20 t	1.40 t

8) Comparison of calendar load torque

Like Cal. 3450, Cal. 3910 is designed to sustain only a light load. Accordingly, the calendar load torque of Cal. 3910 is as low as 0.10 gcm, as shown in the above table. Pay attention to where, how much, and what type of lubricant should be applied. Also, be careful that the parts are not deformed.

(Negligence in observing the above-stated matters may lead to an increase in current consumption, thus making the power cell's lifetime shorter. Also, there may be cases where the watch shows improper operation.)

(Cal. No.)	(Calendar load torque)
CAL 14** series	Approx. 0.43 gcm
CAL 75 series	Approx. 0.40 gcm
CAL 3450	Approx. 0.08 gcm
CAL 3910	Approx. 0.10 gcm

9) Spacer for stator included in some models. Functions and properties are not affected by the presence of the spacer for stator.

7. DISASSEMBLY AND ASSEMBLY OF THE MODULE

Disassembling procedure:
 ① → ③①
 Assembling proced:
 ③① → ①

(Lubrication symbols)

	A Lube
	V Lube
	F Lube
	CH-1

*The movement holder for Cal. 2730 can also be used for Cal. Nos. 3910 and 3920.

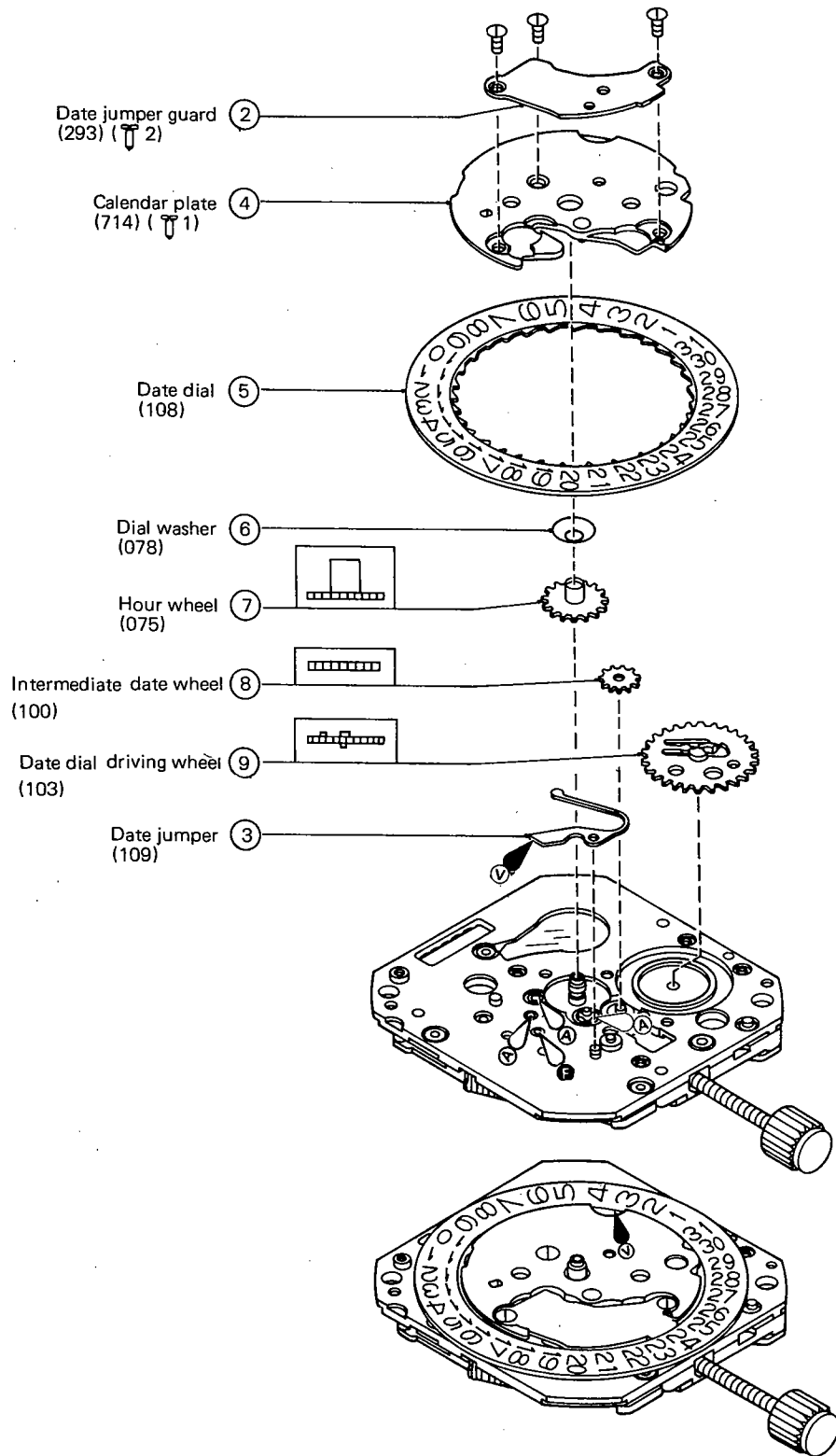

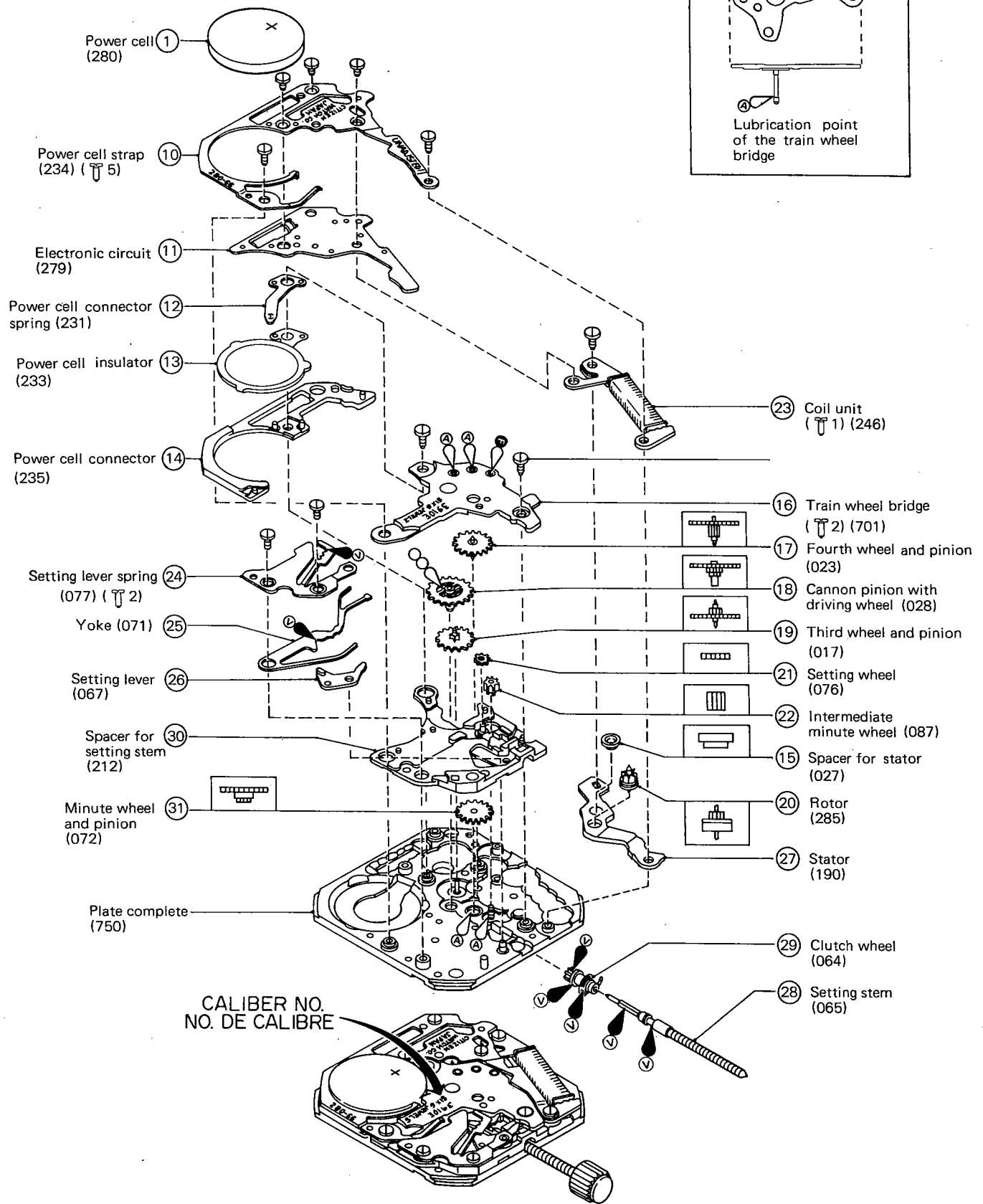

8. TROUBLESHOOTING AND ADJUSTMENT

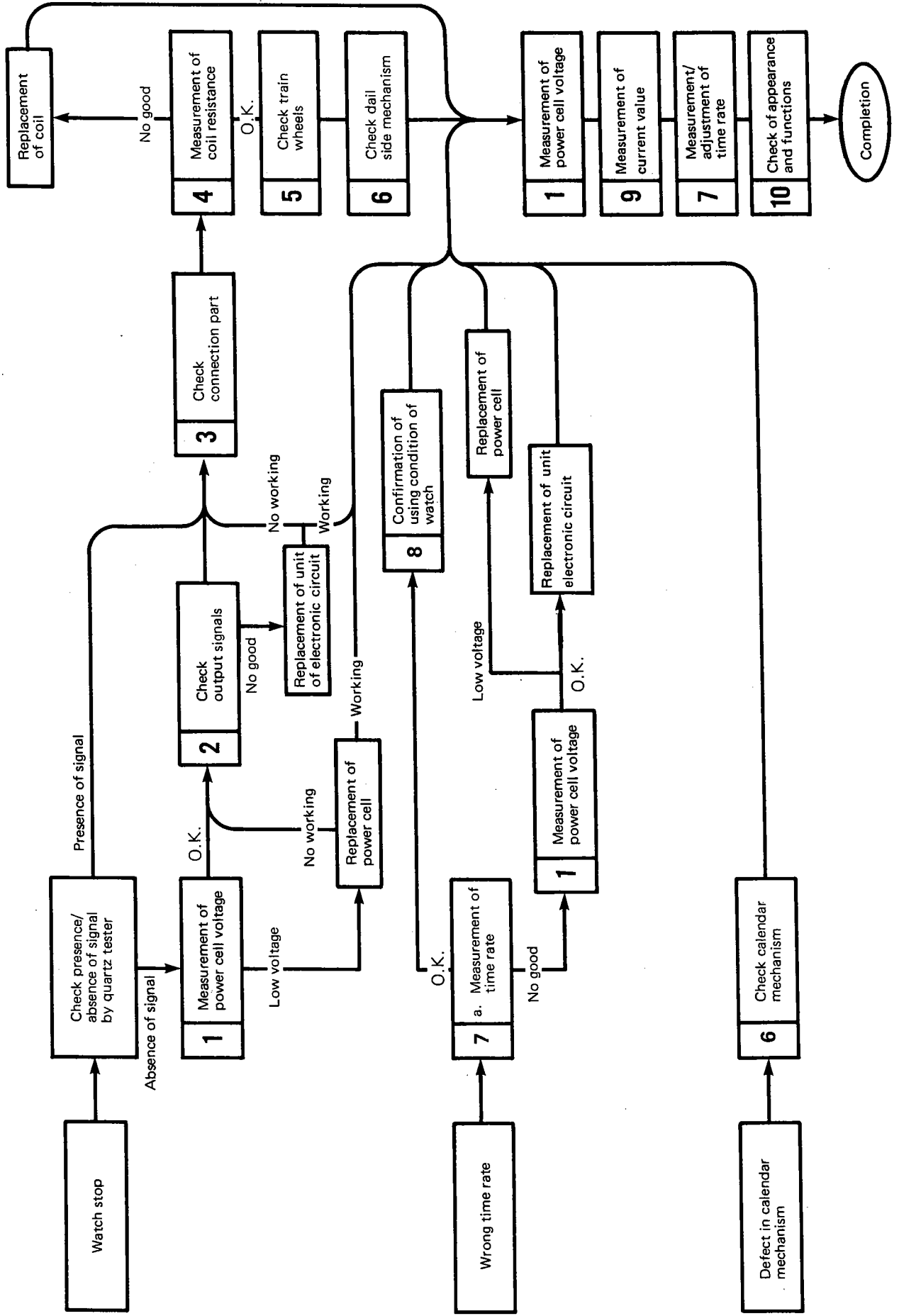

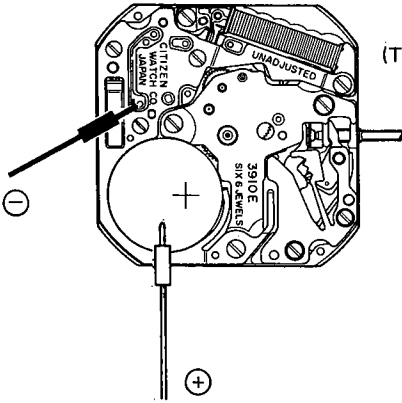
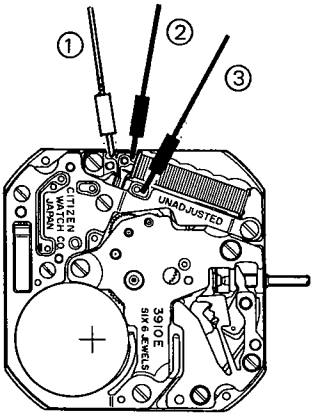
Check points	How to check	Results & treatment
<p>(1) Measurement of power cell voltage</p>	<p>[Refer to Technical Manual Basic Course II-1-a]</p>  <p>(Tester range: DC 3V)</p>	<p>Over 1.5V → Nondefective</p> <p>Under 1.5V → Replace the power cell with a new one.</p>
<p>(2) Check output signal</p>	<p>[Refer to Technical Manual Basic Course II-1-b]</p>  <p>(Tester range: DC 0.3V)</p> <p>Make measurement at Points ① and ② or Points ① and ③</p> <p>In cal. 3910 and 3920, the hand operates based on a 10-second stepping movement, therefore the tester pointer swings right and left once every 10 seconds. (The lead pin has no polarity.)</p>	<p>The tester pointer swings every 10 seconds. → Nondefective</p> <p>The tester pointer does not swing at all. → Replace the electronic circuit unit with a new one.</p>
<p>(3) Check connection parts</p>	<p>[Refer to Technical Manual Basic Course II-2-a]</p> <p>Make sure that the screws have not become loose and that there is no dust or dirt on the connections.</p> <p>a) If the screws for fixing the electronic circuit unit are loose, the driving signal may not be transmitted.</p> <p>b) If there is dust or dirt on the coil or the electronic circuit unit pattern, poor conductivity will result.</p>	

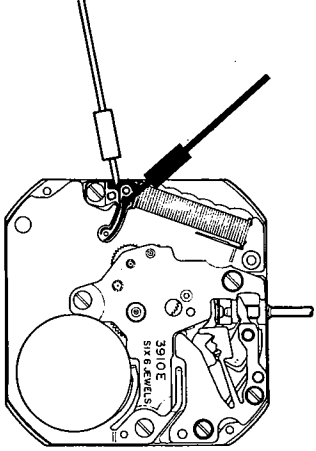
Check points	How to check	Results & treatment
(4) Measurement of coil resistance	<p>[Refer to Technical Manual Basic Course II-1-C]</p> <ul style="list-style-type: none"> ○ Take out the electronic circuit unit to measure the value of the coil resistance.  <p>(Tester range: R x 10Ω)</p>	<p>1.6KΩ – 2.1KΩ → Nondefective</p> <p>1.6KΩ – 2.1KΩ Beyond the above range → Replace the coil with a new one.</p>
(5) Check train wheels	<p>[Refer to Technical Manual Basic Course II-2-b]</p> <ul style="list-style-type: none"> ○ Check that the transmission goes smoothly, that each gear has the appropriate clearance, and that there is not dust around the rotor. ○ In this Cal. No. 3910, if too much lubricant is applied to the calendar side mechanism, the calendar may not be correct. Therefore, it is necessary to check that it is not excessively lubricated. ○ Apply an extremely small amount of lubricant to the center shaft of the train wheel bridge. If excessively lubricated, lubricant will flow out of the hole in the cannon pinion with the driving wheel and may make the hands dirty. 	
(6) Check dial side mechanism (Calendar side)	<p>[Refer to Technical Manual Basic Course II-2-C]</p> <ul style="list-style-type: none"> ○ Cal 3910 requires the following checks; whether the date dial operates properly, whether quick correction is made smoothly. 	
(7) Measurement of the time rate	<p>[Refer to Technical Manual Basic Course II-2-d]</p> <ul style="list-style-type: none"> ○ Cal Nos. 3910 and 3920 adopt the DFC, therefore the time rate does not need to be adjusted on the market level. (Measurement of the time rate: 10 seconds) 	<p>If they substantially lose or gain time → Replace the electronic circuit unit with a new one.</p>
(8) Confirmation of using condition of the watch	<p>[Refer to Technical Manual Basic Course II-2-e]</p>	

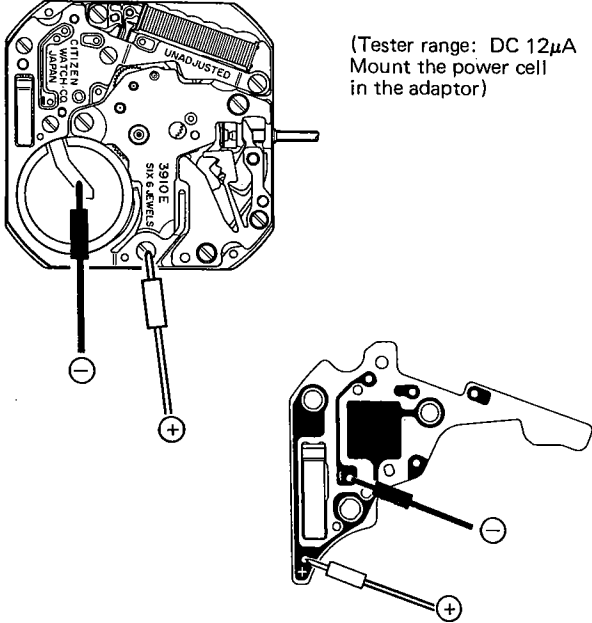
Check points	How to check	Results & treatment
<p>(9) Measurement of the current value</p>	<p>[Refer to Technical Manual Basic Course II-1-f]</p>  <p>(Tester range: DC 12μA Mount the power cell in the adaptor)</p> <p>a) Cal. Nos. 3910 and 3920 are incorporated with a load compensating circuit. This circuit has the function of adjusting output for driving the rotor. When the power cell is mounted, the above-stated function will operate for a few seconds and consequently current consumption may temporarily reach around 1μA. In this case, make the measurement after the tester pointer has returned to the normal level.</p> <p>b) Measuring current consumption used for resetting; First, set the tester and its lead pins the same way as in the measurement of the module's current consumption. Push the crown back into its normal position and start the watch. Then, pull the crown out to the time setting position (a state in which power is saved), and measure the current consumption used for resetting. If not observing the above procedure, an extremely high value of current consumption may be shown due to the IC's constitution.</p> <ul style="list-style-type: none"> ○ If the value of current consumption for resetting is below 0.3μA, the watch has good quality. 	<ul style="list-style-type: none"> ○ Current consumption of the module Under 0.5μA → Nondefective Over 0.5μA → Measure the electronic circuit unit singularly. ○ Measurement of the electronic circuit unit Under 0.2μA → Nondefective Over 0.2μA → Replace the electronic circuit unit with a new one.
<p>(10) Check appearance conditions and functions</p>	<p>[Refer to Technical Manual Basic Course II-2-f]</p> <ul style="list-style-type: none"> ○ The date display of Cal. 3910 changes at 3:00 AM. Mount the hands with this fact in mind. <p>(The power cell strap is electrically grounded by contact with the case back, thus protecting the circuit from static electricity.)</p>	

CITIZEN WATCH CO., LTD.

Tokyo, Japan