

***TECHNICAL
INFORMATION***

**CITIZEN QUARTZ
Cal. No. 27※※※**

■1. OUTLINE



This is an analog quartz watch for gentlemen and newly designed and completed through the latest electronics technology and superb machining technique of Citizen.

It features a unique IC temperature compensating function to attain an extremely high accuracy of ± 10 seconds per year.

Furthermore it realizes the unisexual use of a wristwatch thanks to its small and thin structure of the movement.

■2. FEATURES

1) Small and thin structure of movement:

The size of the movement ($18 \times 18 \times 22\phi \times 1.9^t$ mm) is minimized as less as possible for a men's wristwatch.

2) IC temperature compensating function:

A temperature sensor incorporated into an IC catches the ambient temperature and produces the compensation signal to apply the feedback to an oscillating circuit. This suppresses the fluctuation of frequency which is caused by a change of temperature. As a result, an extremely high accuracy (± 10 sec./year) is attained.

3) Variety of designs:

A variety of appearance designs is possible with a small and thin structure of the movement. Especially the position of the setting stem is put closer to the dial to ensure a better fit to a wrist of the wearer.

4) A long life of power cell:

A long life of about 2 years is attained for a single unit of miniature power cell of silver oxide. This is thanks to the development of the following two circuits of low power consumption: a control-type constant voltage circuit (oscillation current) and a load compensating circuit (drive current) respectively.

■3. CALIBER NOS. FOR CONTROL IN FACTORY

The following two caliber numbers are used exclusively for the purpose of control in the factory and will be integrated to E or F with the products on the market.

1) Cal. No. 2710(W)/(X)-06

This caliber is born by using a black color for the date dial of Cal. No. 2710E/F. Accordingly other specifications are identical with those of the Cal. No. 2710E/F.

2) Cal. No. 2710(T), (U), (V)-06

With this caliber, the window of the calendar is set at the 6-o'clock position and the white (T), gold (U) and black (V) colors are used for the date dial respectively. Other specifications are identical with those of Cal. No. 2710F.

■ **SPECIFICATIONS**

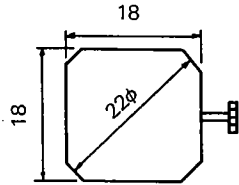
| | | | | | |
|-----------------------------------|-----------------------------|---|----------|--|----------|
| Caliber Nos. | | 2710E-61 | 2710F-06 | 2730E-06 | 2730F-06 |
| Type | | Analog quartz watch (w/center second) | | | |
| Size of movement (mm) | |  | | | |
| | | 18 x 18 x 22φ | | | |
| | | 2.28 ^t (incl. power cell part) | | 1.9 ^t (incl. power cell part) | |
| Frequency | | 32,768Hz | | | |
| Effective temp. range | | -10°C ~ +60°C (14°F ~ 140°F) | | | |
| Converter | | Bipolar step motor | | | |
| Integrated circuit | | C/MOS-LSI (1 unit) | | | |
| Annual accuracy (At normal temp.) | | ±10 sec. | ±20 sec. | ±10 sec. | ±20 sec. |
| Additional functions | Calendar | ○ | ○ | - | - |
| | Quick setting of calendar | ○ | ○ | - | - |
| | Second hand stopping device | ○ | ○ | ○ | ○ |
| | Power saving switch | ○ | ○ | ○ | ○ |
| | Power cell life indicator | ○ | ○ | ○ | ○ |
| Adjustment of time rate | | By trimmer condenser | | | |
| Power cell (Silver oxide) | | Cell code : SR716SW (Hitachi Maxel Ag ₂ O/NaOH) Parts No. : 280-56 (1 unit) Size (mm) : 7.9φ x 1.6 ^t Voltage : 1.55V Capacity : 18mAH Lifetime : About 2 years | | | |

* Annual accuracy

The monthly accuracy of this caliber featuring an annual accuracy system is not always equal to an exact 1/12 annual accuracy.

As shown in the following table, some error will be caused according to the using conditions of the watch.

* The "normal temp." varies 5°C ~ 35°C, and the accuracy of a watch defines the use of about 12 hours a day in the above-mentioned range of temperatures.

| Cal. Nos. | Annual accuracy | Monthly accuracy |
|------------|-----------------|------------------|
| 2710/2730E | About 10 sec. | About 2 sec. |
| 2710/2730F | About 20 sec. | About 4 sec. |

■5. HANDLING INSTRUCTIONS

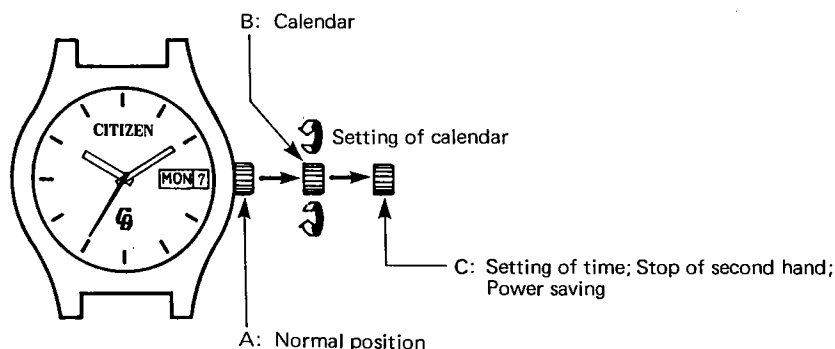

- 1) The time is set/corrected by pulling out the crown up to position C and turning the crown clockwise and counterclockwise. Never fail to make sure of AM or PM. It indicates 12:00 midnight at a moment when the date changes at 12:00.
- 2) The watch starts with a soft push of the crown.
- 3) The calendar is set/corrected by turning the crown counterclockwise at position B.
- 4) The crown must be pushed back to position A after the setting/correction is over for time and calendar.

(Note) Cal. No. 2730E(F) lacks the calendar mechanism, and the time is set/corrected with the crown at position B.

■6. STRUCTURE OF MOVEMENT

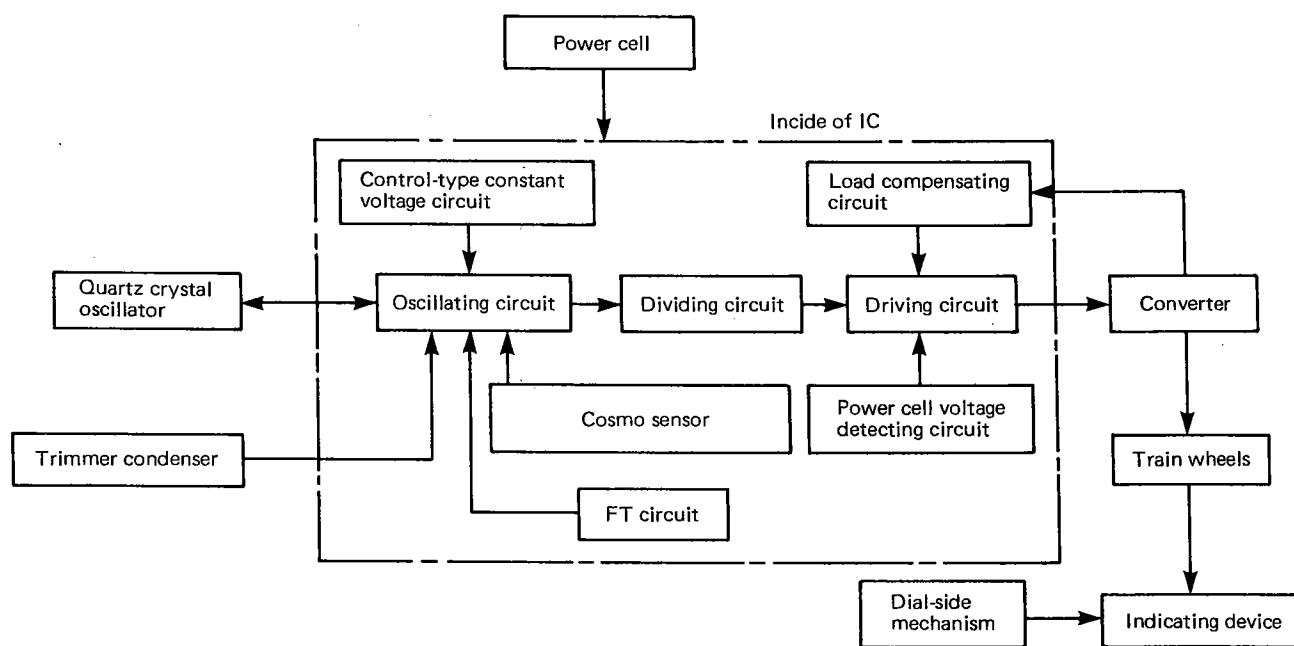

Outline of each function:

- Control-type constant voltage circuit

This circuit functions to save the power consumption and to keep a constant level of the voltage which is applied to the oscillating circuit.

It is impossible to supply a constant level of voltage to the oscillating circuit if the power cell voltage is directly applied to the oscillating circuit since the power cell has its own variance of voltage (caused by the aging or the fluctuation of temp.)

With application of this control-type constant voltage circuit, the fluctuation of frequency of a quartz crystal oscillator due to the variance of the applied voltage can be avoided.

- FT circuit

This circuit performs the rough control to the fluctuation of the numerical value which is set for production of a quartz crystal oscillator or an IC. After the rough control with this circuit, the fine adjustment is carried out by a trimmer condenser.

- Temperature compensating function (Cosmo sensor)

A temperature-sensitive element (temperature sensor) is incorporated into an IC to catch the ambient temperature of the watch. Based on this temperature information, the oscillating condenser is controlled. Thus the variance of the oscillator frequency due to the fluctuation of temperature is controlled.

- Load compensating circuit

This circuit detects the driving state of a rotor and then supplies the driving pulse of the minimum level to drive the rotor.

- Power cell voltage detecting circuit

This circuit actuates the output signal of a driving circuit in case the voltage of the power cell drops down to a certain level. As a result, the second hand has a step movement with every 2 seconds. (Power cell life indicator)

1) Temperature properties of quartz crystal oscillator

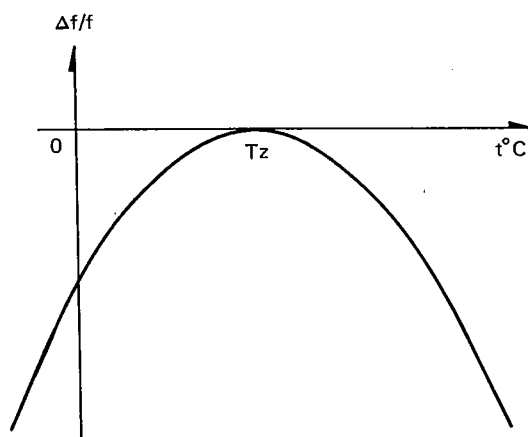

Fig. 1

As shown in Fig. 1, the time rate of a quartz crystal oscillator has a delay every moment when the temperature varies centering on the zero temperature coefficient (T_z).

In other words, the time rate is proportional to a square of the difference between the ambient temperature and the zero temperature coefficient. As a result, a curve of secondary degree is obtained as shown in Fig. 1.

2) Conventional temperature compensating function

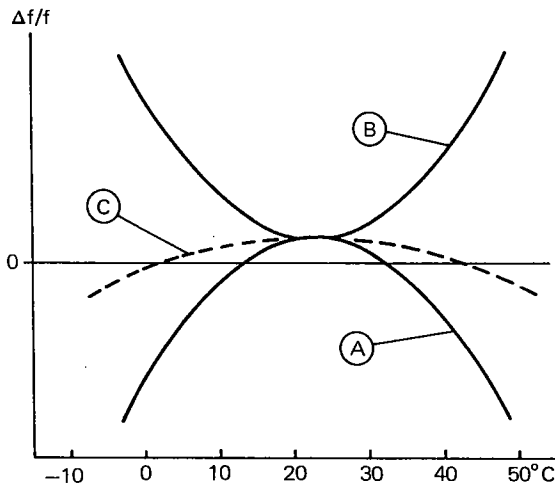

Fig. 2

Fig. 2 shows the compensation of frequency which is performed by a temperature compensating condenser. As mentioned in 1), an ordinary quartz crystal oscillator varies its frequency by the temperature as shown by curve (A).

Thus the temperature properties of the temperature compensating condenser (curve (B)) is compounded with the curve (A) to obtain a comparatively flat curve (C).

3) IC temperature compensating function (Cosmo sensor)

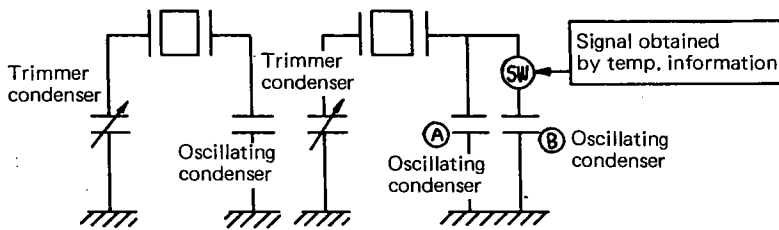

Fig. 3-1

Fig. 3-2

As shown by Fig. 3-1, an ordinary oscillating circuit (feedback circuit) feeds the frequency (32kHz) of a quartz crystal oscillator back to an IC via the oscillating condenser and the trimmer condenser.

The rough control is carried out to the frequency of the oscillator by the oscillating condenser. Then the frequency is controlled at each ambient temperature by setting mechanically the capacity value through the trimmer condenser.

The temperature compensation within an IC is carried out by setting two trimmer condensers and oscillating condensers each and controlling the frequency (Fig. 3-2).

The capacity value of condenser (A) is set slightly less than the conventional one to obtain a gain of the time rate. While condenser (B) receives the signal corresponding to the temperature information for the IC and performs the switch ON/OFF. In other words, the condenser (B) gives the compensation to the gain obtained by the condenser (A) and functions to secure a constant change of frequency for the quartz crystal oscillator (XY-cut) at each temperature. As a result, an extremely high accuracy is attained in an annual display of error.

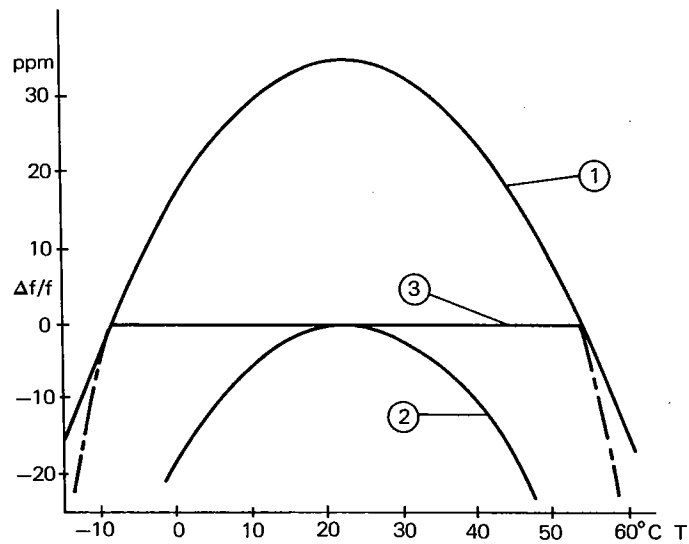

Fig. 3-3

Fig. 3-3 shows the frequency properties of a quartz crystal oscillator with the connection and disconnection of an oscillating condenser.

The changes of frequency are shown by curves ① and ② when the oscillating condenser is off and on respectively. The switching is carried out between these two curves by switching on and off the oscillating condenser. Thus an average and flat curve ③ is obtained for the frequency.

• Temperature compensation system

(Outline of System)

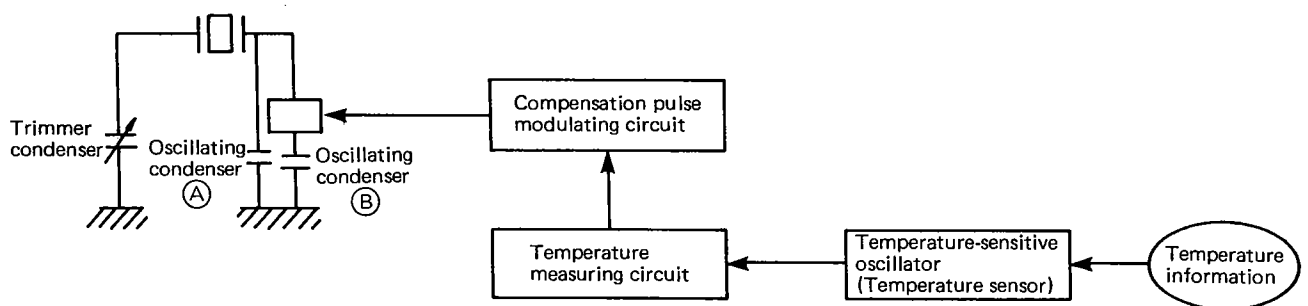

1) Temperature-sensitive oscillator (Temperature sensor)

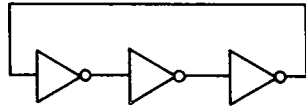

Fig. 4

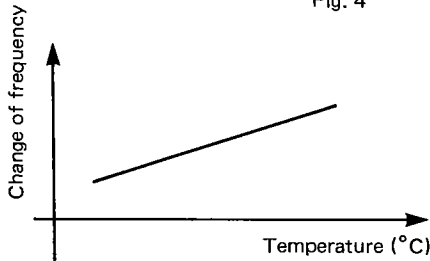

Fig. 5

The temperature and then the frequency vary by connecting an odd number of inverters as shown in Fig. 4.

As shown by Fig. 5, the frequency increases as the temperature rises and vice versa since the change is proportional between the temperature and the frequency.

The working voltage of a temperature-sensitive oscillator is kept at a certain level (1.5V) by the function of a constant voltage circuit. Thus no change of frequency is caused by a change of voltage, and as a result this oscillator detects only the temperature change to have an oscillation corresponding to each temperature.

2) Temperature measuring circuit

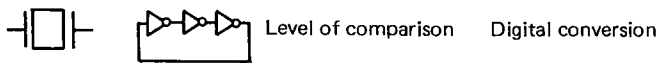

| | | | |
|--------------|-------|--------|-----------|
| 32KHZ (10°C) | 9KHZ | Low | 0 0 |
| 32KHZ (24°C) | 10KHZ | Middle | 0 1 |
| 32KHZ (30°C) | 11KHZ | High | 1 0 |

Fig. 6

Fig. 6 shows an outline of function of a temperature measuring circuit. This circuit compares the oscillation frequency obtained by the temperature-sensitive oscillator with 32,768Hz of a quartz crystal oscillator and converts the oscillation into the digital value.

This digital conversion is set in 511 different ways. As a result, the digital conversion is given to oscillation frequency of the temperature-sensitive oscillator with a difference of temperature of about 0.1°C.

3) Compensation pulse modulating circuit

This circuit determines the duration of time for an oscillating condenser per unit time based on the information of the digital conversion obtained by the temperature measuring circuit.

In other words, the signal to turn on and off a switch connected to the oscillating condenser is delivered from this circuit. This signal is delivered with every 2 seconds.

7. DISASSEMBLY/ASSEMBLY OF MOVEMENT

1) Dial side

Disassembling procedure : ① → ③⑤
 Assembling procedure : ③⑤ → ①

Marks of lubrication:

- Ⓐ Synt-A-Lube oil
- Ⓥ Synta-V-Lube oil
- Ⓒ Citizen watch oil CH-1
- ∞ Synta-F-Lube oil

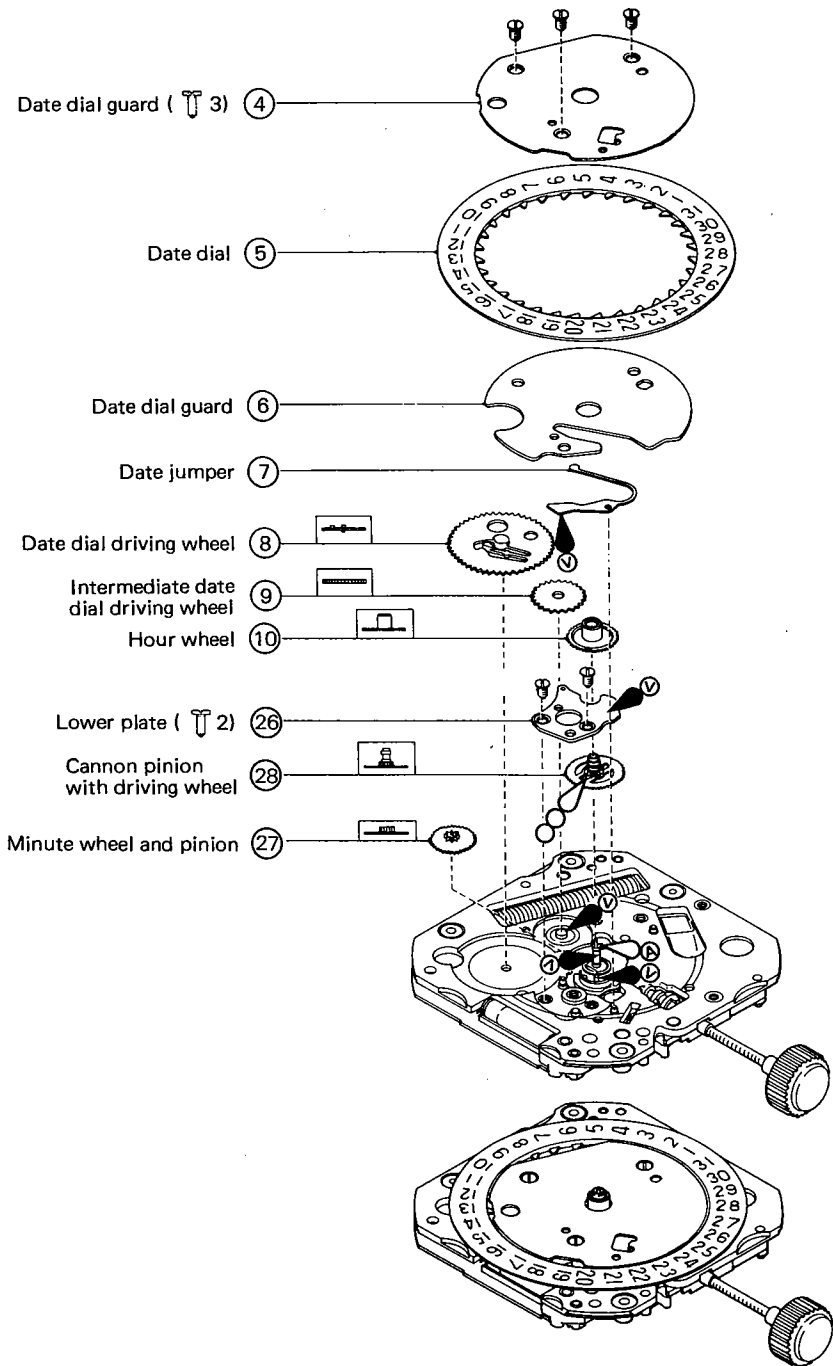

Note:
 No washing is required for the electronic parts. The dust or stains sticking to the electronic parts must be cleared away to ensure the high performance of contact.

2) Power cell side

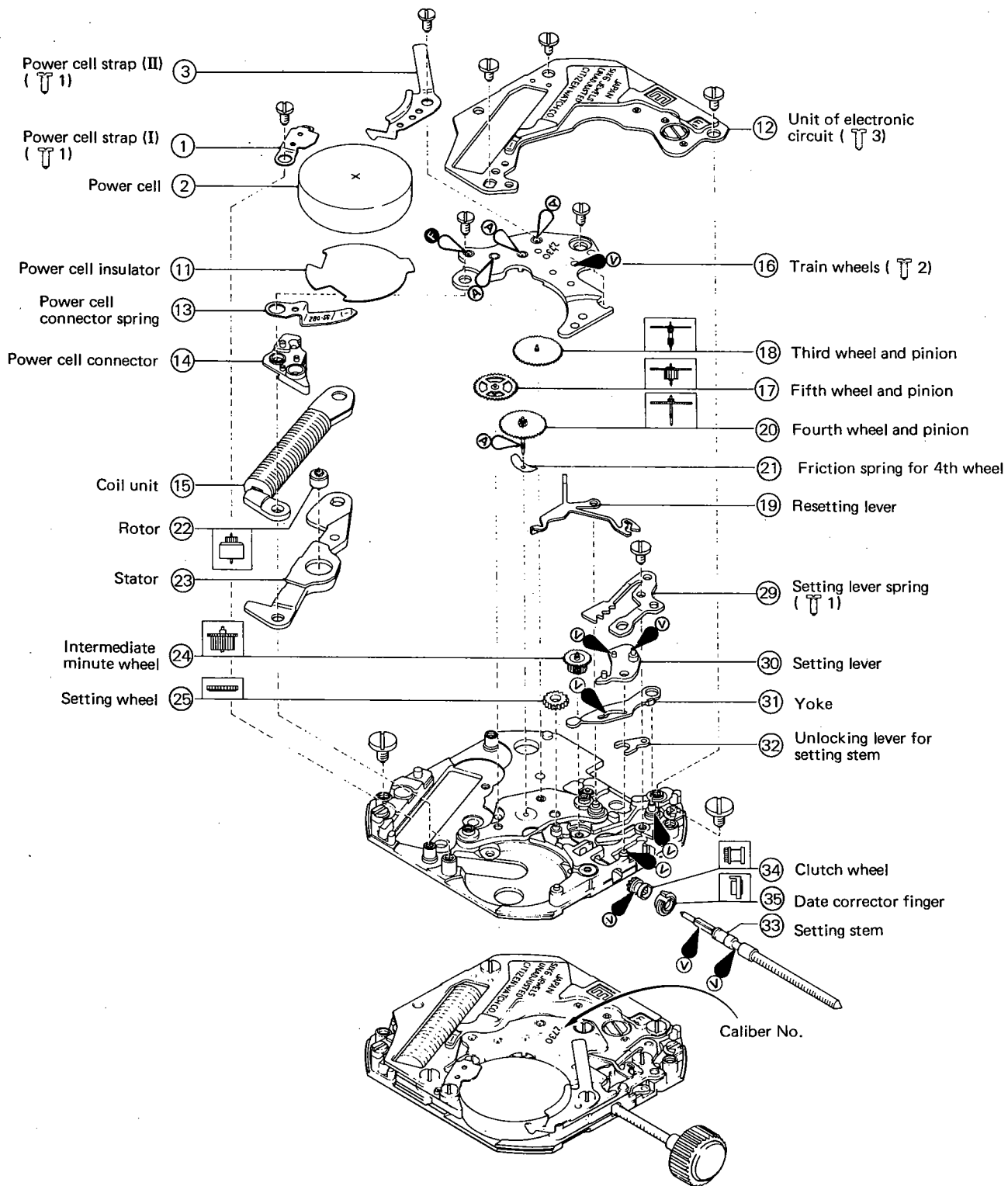

■8. NOTES ON DISASSEMBLY/ASSEMBLY

1) How to unset power cell

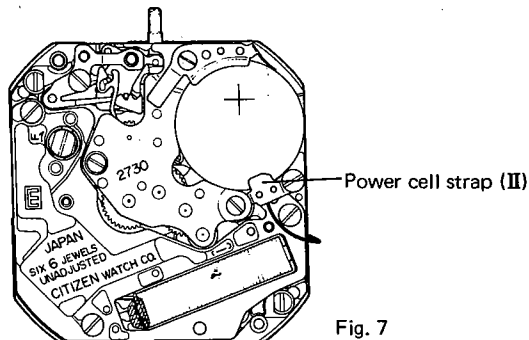

Fig. 7

The power cell strap is unset by unfastening a screw for power cell strap (II) and turning the strap toward an arrow as illustrated in Fig. 7.

2) Handling of resetting lever

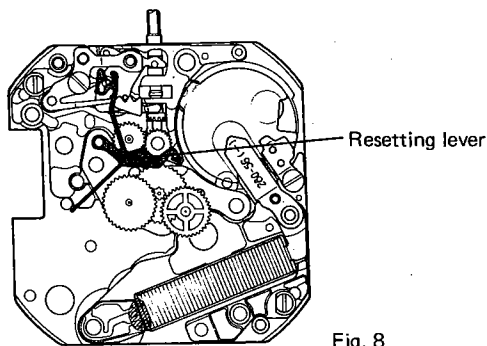

Fig. 8

A resetting lever has legs extending in four directions and must be handled with good care to avoid any malformation, etc.

The crown must be set at its normal position before assembling the train wheels because the resetting lever hits the fourth wheel and prevents the assembly of the train wheels.

3) Friction spring for fourth wheel

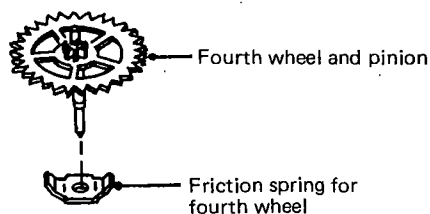

Fig. 9

This caliber uses a friction spring for fourth wheel to prevent the variance of the second hand. As shown in Fig. 9, the friction spring for fourth wheel of this caliber has a different form from the conventional one and is set under the fourth wheel. When disassembling or washing, the good attention must be paid not to miss this friction spring.

4) Power cell strap (I)

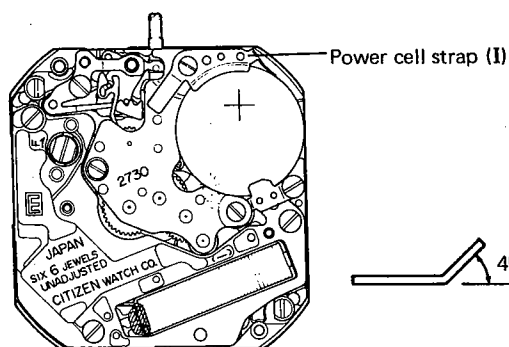
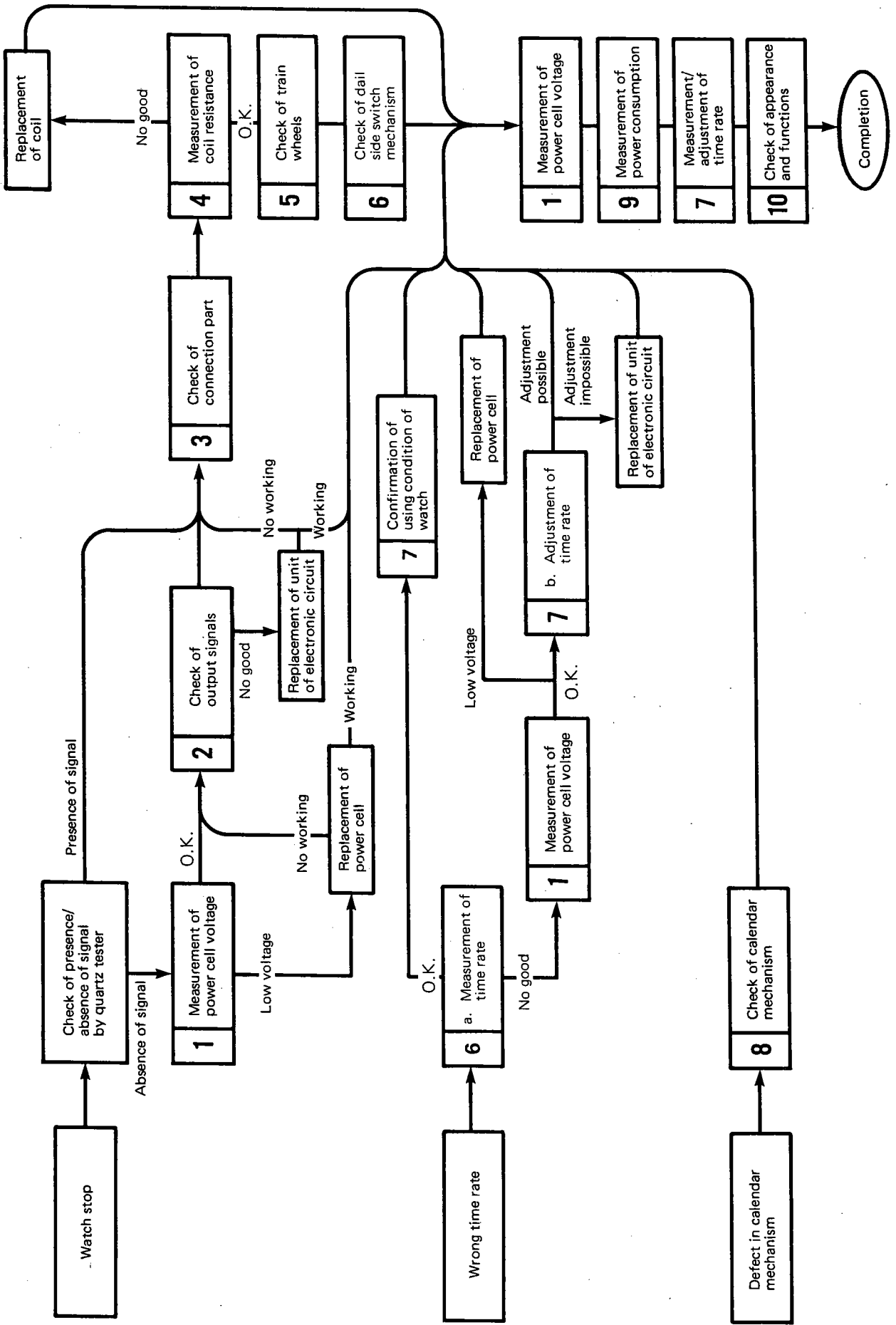

Fig. 10

A power cell strap (I) functions to fix the power cell as well as to secure the earth to the case back to prevent the static electricity.

In this connection, the bend of this strap must be properly set at 45° as shown in Fig. 10.

■ 9. TROUBLESHOOTING AND ADJUSTMENT

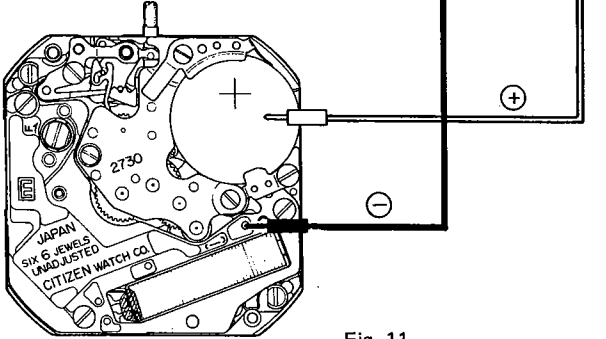
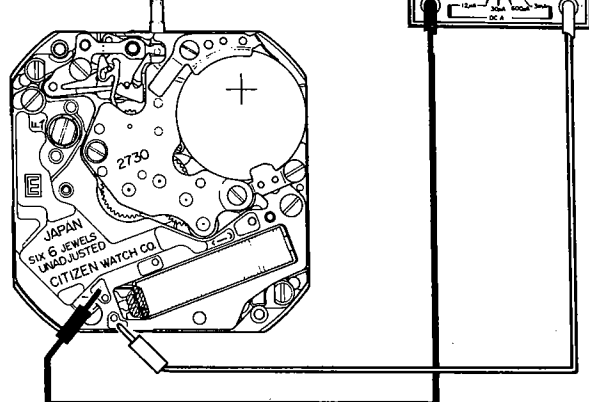

| Checking items | How to check | Results and treatment |
|--|---|--|
| <p>1 Measurement of power cell voltage</p> | <p>As illustrated in Fig. 11, the lead terminals of a tester are applied to the upper face (+) of the power cell and the minus pattern (-) of the unit of electronic circuit respectively for measurement.</p> <p>In this case, make sure that the screws for unit of electronic circuit are driven tight.</p>  <p>(Tester range: DC 3V)</p> <p>Fig. 11</p> | <p>Over 1.5V → Nondefective</p> <p>Under 1.5V → Replacement of power cell</p> |
| <p>2 Check of output signals</p> | <p>As shown in Fig. 12, the lead terminals of a tester are applied to the pattern of the unit of electronic circuit to check the output signal.</p>  <p>(Tester range: DC 0.3V)</p> <p>Fig. 12</p> | <p>Tester pointer swinging right and left centering on 0V → Nondefective</p> <p>No swinging of pointer → Replacement of unit of electronic circuit</p> |
| <p>3 Check of connection part</p> | <p>The dust or stains sticking to the unit of electronic circuit and each connection part will prevent the output of the signal.</p> <p>No signal is delivered also in case the screws for unit of electronic circuit are not driven tight. So make sure that these screws are fastened completely.</p> | <p>Dust or stains → To be cleared off</p> |

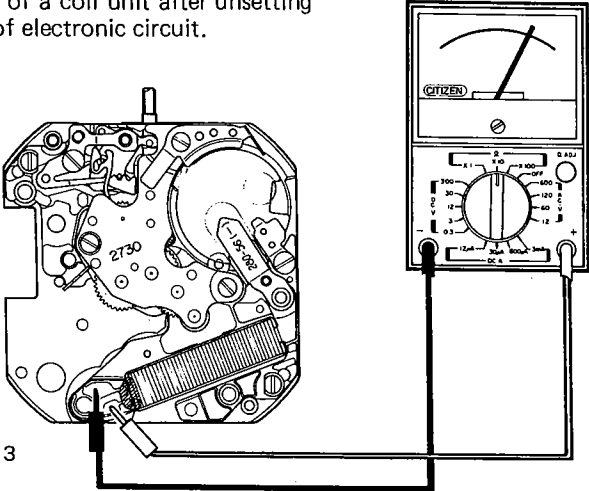
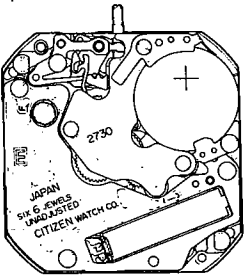
| Checking items | How to check | Results and treatment |
|--|--|---|
| <p>4 Measurement of coil resistance</p> | <p>The lead terminals are applied to the terminals of a coil unit after unsetting the unit of electronic circuit.</p> <p>(Tester range: X10)</p>  <p>Fig. 13</p> | <p>2.6 ~ 3.2kΩ → Nondefective</p> <p>Outside 2.6 ~ 3.2kΩ → Replacement of coil unit</p> |
| <p>5 Check of train wheels</p> | <p>Make sure that all wheels bite with each other in a smooth and correct way and that the lubrication is appropriate.</p> | |
| <p>6 Check of dial-side mechanism</p> | <p>Make sure that the hands are turned smoothly (with a proper slip torque) and that the resetting lever has an assured function.</p> | |
| <p>7 Measurement/adjustment of time rate</p> | <p>The time rate is measured by Citizen Quartz Tester (CQT-101). The frequency is roughly controlled (for factory) by an FT circuit, and a fine adjustment is carried out for the time rate by means of a trimmer condenser.</p> <p>The adjusting accuracy of the FT circuit is about 6ppm (0.5 sec./day). Accordingly the trimmer condenser has a small change of capacity and is designed so as to facilitate an easy adjustment of the time rate.</p> <ul style="list-style-type: none"> ● Adjustment of time -- <p>The measurement of time rate is possible with CQT-101 with the time unit of 2 seconds.</p> <p>However, the measurement is carried out with the unit time of 4 seconds and 10 seconds respectively when the display of the tester has a variance.</p> <p>The adjustment is carried out in a range of ±0.00 ~ 0.03 for a watch of the annual accuracy ±10 seconds and in a range of ±0.00 ~ 0.05 for a watch of the annual accuracy ±20 seconds respectively owing to the following formulas.</p> <ul style="list-style-type: none"> • ±10 sec./year → ±10/12 sec./month → ±10/12 × 30 sec./day → 0.028 sec./day • ±20 sec./year → ±20/12 sec./month → ±20/12 × 30 sec./day → 0.055 sec./day <ul style="list-style-type: none"> ● Change of time rate due to open/close of case back <p>No change is caused to the time rate by opening/closing the case back since the quartz crystal oscillator has an ordinary oscillation of 32kHz. The time rate is, however, must be confirmed even after closing the case back since this caliber features a display of annual accuracy.</p> |  <p>Trimmer condenser (Clockwise turn: Gains)</p> <p>Fig. 14</p> |

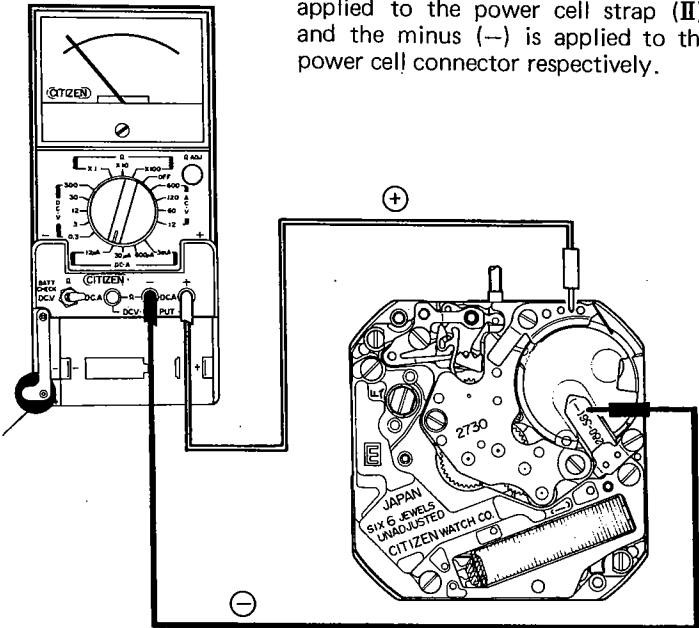
| Checking items | How to check | Results and treatment |
|---|---|--|
| | <p>●Temperature of measurement</p> <p>The number of compensation pulses increases as the room temperature changes from 24°C. This results in a variance of the time rate. In this respect, the best result of measurement is obtained at the temperatures near 24°C.</p> | |
| <p>8 Confirmation of using condition of watch</p> | <p>The accuracy of a watch will be affected by the environment in which the watch is used such as the magnetic field, an extremely high or low temperature, the humidity, the impact and so on.</p> <p>Also make sure how many days have passed since the last adjustment was given to the time rate.</p> | |
| <p>9 Measurement of power consumption</p> | <p>(Tester range: 12μA)</p>  <p>The plus (+) lead terminal of a tester is applied to the power cell strap (II), and the minus (-) is applied to the power cell connector respectively.</p> <p>Fig. 15</p> <p>●Note on measurement</p> <p>A load compensating circuit is used in this watch and functions to control the driving output according to the waveform obtained with the rotation of a rotor. This circuit functions for 10 ~ 30 seconds at a moment when the power cell is set into the watch.</p> <p>In this case, the power consumption measures about 1.7μA and may be decided defective. And the correct value of power consumption will be obtained by carrying out the second measurement in maximum 30 seconds after the functioning of the load compensating circuit.</p> | <p>1.2μA or less</p> <p>→ Nondefective</p> <p>Outside 1.2μA</p> <p>→ Measurement of power consumption with unit of electronic circuit only</p> <p>Measurement of unit of electronic circuit:</p> <p>Under 0.4μA</p> <p>→ Nondefective</p> <p>Over 0.4μA</p> <p>→ Replacement of unit of electronic circuit</p> |
| <p>10 Check of appearance and functions</p> | <p>Finally the following points are checked with a finished watch.</p> <ol style="list-style-type: none"> 1) The surface of the dial is completely free from the dust, stains and other foreign matters. 2) The crown operates in a correct and smooth way. 3) Both the second hand stopping and time setting operations are possible with the crown set at position C (second click stop). (Cal. No. 2710) | |

CITIZEN WATCH CO., LTD.
Tokyo, Japan