

TECHNICAL INFORMATION

CITIZEN QUARTZ

Cal. No. 20※※※

Cal. No. 21※※※

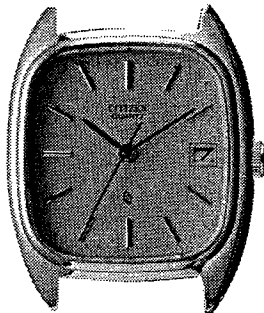

[CAL. NO. 20※※※]
[CAL. NO. 21※※※]

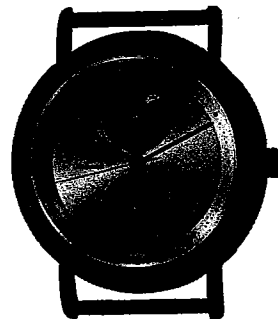

[CAL. NO. 218※※]

S1. OUTLINE

Cal. 20*** and 21*** series are analog quartz watches which are realized through a reduction of the numbers of component parts and a mass production system, through, thus playing an important role in leading the wristwatch market with reasonable prices.

They feature a very thin movement plus a good design of watch.

Cal. 20*** series are for ladies and Cal. 21*** series for gentlemen.

Cal. 2180* is an analog quartz watch with additional display functions and a handsome functional design.

With the moon's age display and sun display, it can tell the moon's phase as well as the positions of the moon and the sun. Furthermore, the moon's age display can be corrected quickly and independently.

§3. SPECIFICATIONS

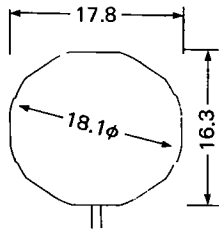
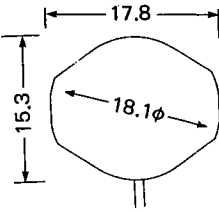
Caliber No.		2000A-01, 02 2001A-01, 02 2002A-01, 02	2010A-01, 02	2020A-01, 02	2030A-01, 02 2031A-01, 02
Type		Analog quartz crystal watch			
		(w/center second)	(w/no center second)	(w/center second)	
Movement	Size (mm)				
	Thickness (mm)	3.8		2.8	
	Thickness at power cell part (mm)	4.15		3.15	
Accuracy		±20 sec./month at normal temperatures			
Oscillation		32,768Hz			
Effective temperature range		-10°C ~ +60°C (14°F ~ 140°F)			
Integrated circuit		C/MOS-LSI (1 unit)			
Converter		Bipolar step motor			
Adjustment of time rate		By DFC (Digital Frequency Control) method with unit time of measurement of 10 sec. and with no terminal for adjustment)			
Additional functions	Date (w/quick setting)	✓ Yes	Yes	No	No
	Day (w/quick setting)	Yes	No	No	No
	Bilingual display of days of the week	Yes	No	No	No
	Second hand stopping device	Yes	Yes	No	Yes
	Power saving switch	Yes	Yes	Yes	Yes
	Load compensating circuit	Yes	Yes	Yes	Yes
	Dual time	No	No	No	No
Power cell (silver oxide cell)		280-39 (SR-626SW, Ag ₂ O/NaOH)			
Parts. No.					
Size (mm)		6.8φ x 2.6 ^t			
Capacity		26mAH			
Nominal voltage		1.55V			
Lifetime		About 2 years		About 3 years	

2040A-01, 02 2041A-01, 02	2100A-01	2110A-01	2140A-01	2180-0
(w/small second)	(w/center second)			
3.6	3.8	3.7	3.7	
3.95	4.15	4.05	4.0	
No	Yes	Yes	No	No
No	Yes	No	No	No
No	Yes	No	No	No
Yes	Yes	Yes	Yes	Yes
Yes	Yes	Yes	Yes	Yes
Yes	Yes	Yes	Yes	Yes
No	No	No	Yes	No
<p>Moon dial display period Approx. 24 hr. 50.49 min. (The average rotation period of the earth on its axis using the moon as reference is 24 hr. 50.47 min., which causes an annual delay of approx. 7 minutes with the moon dial display.)</p> <p>Moon's age display period Approx. 29.57 days (The average period of a synodical month is 29.530589 days, which causes an annual delay of approx. 0.5 days with the moon's age display.)</p> <p>Sun dial display period 24 hours (The average rotation period of the earth on its axis using the sun as reference.)</p>				
Approx. 2 years			Approx. 2 years	

53. HANDLING INSTRUCTIONS

3-1. CAL 20***/21*** (Except 218**)

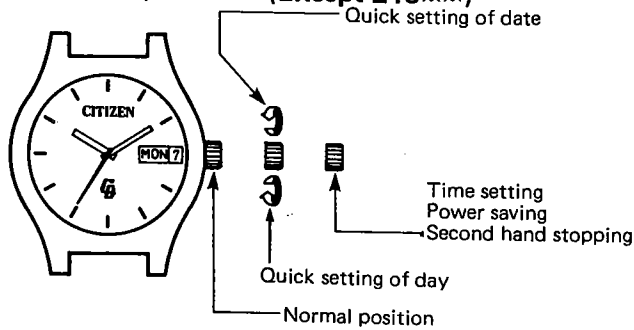

(Note) The crown must always be set at the normal position before it is pulled out at the 1st click-stop position.

*Avoid giving a quick setting to both the date and day displays while the calendar mechanism is working.

Working Time of Calendar

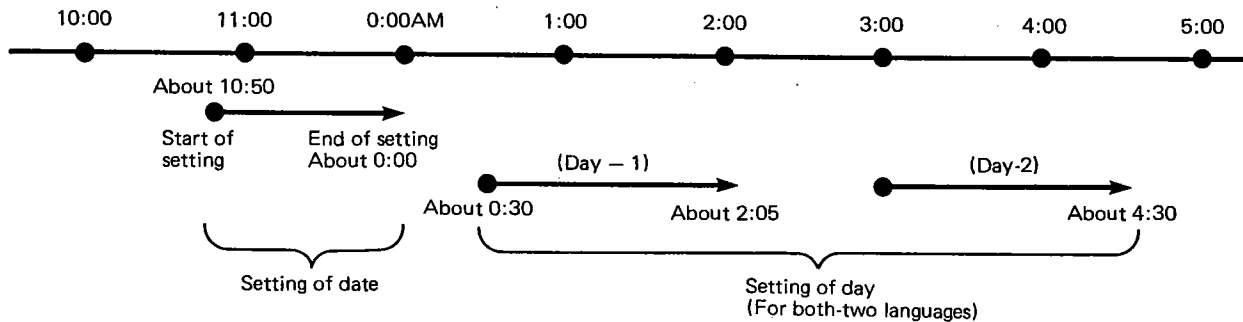

- A quick setting of day is impossible during the working time of day (about 0:30AM ~ about 4:30 AM).
(Even if such quick setting is carried out, no damage is given to the watch function.)
- In case a quick setting is given to the date during the working time of date (about 10:50PM ~ about 0:00AM), the date does not change even after 0:00AM (with the crown pushed back to its normal position and the timing advanced).

The crown must be set at its normal position after setting the time and calendar.

*It rarely occurs that the second hand has a backward turn during a turning of hands. (Such phenomenon will occur when the hands are turned backward suddenly and consciously after a consecutive forward turning, and this scarcely occurs in the normal way of turning of hands.) This is due to the fact that only the train wheels (rotor and fifth wheel) are used instead of a brake lever to prevent a rotation of the train wheels during a turn of hands. Thus the second hand may turn backward in a slight probability. Such phenomenon, however, does not affect the watch function at all.

<CAL. 2140A>

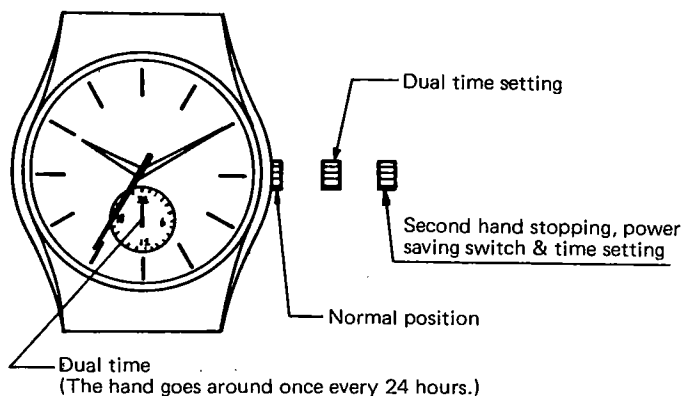

Time setting should be made first with the crown remaining pulled out to the second clicking position. (At this time, the hand for dual time also goes round.) Then, the dual time should be set to the right time with the crown remaining pulled to the first clicking position.

After setting time, be sure to push the crown back to its normal position and then use the watch.

If the watch is used with the crown remaining pulled to the first clicking position, the dual time does not move.

3-2. 218※※

1) Names of the parts and their functions

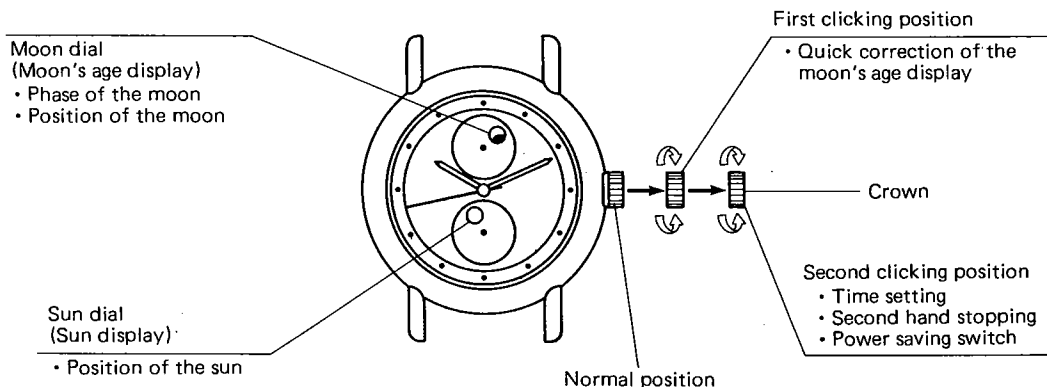

2) Method for reading the moon dial and the sun dial

- The position of the moon and the sun can be learned from where the moon dial and the sun dial rotate.

Culmination above and below an observer ... Culmination above an observer is a phenomenon that occurs when a celestial body passes the meridian which connects the celestial north pole, the zenith (the point on the celestial sphere vertically above an observer) and the celestial south pole.

Culmination below an observer is a phenomenon that occurs when a celestial body passes the meridian that connects the celestial north pole, the nadir (the point on the celestial sphere directly below an observer) and the celestial south pole.

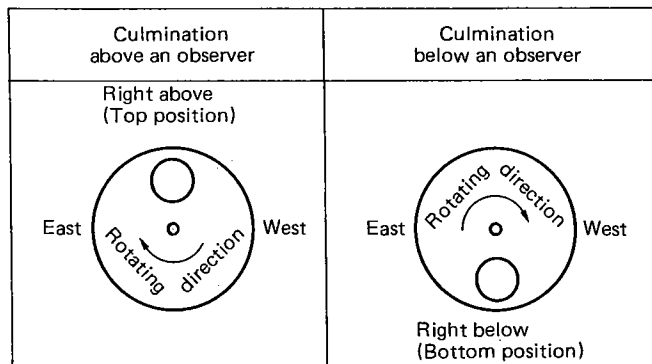

- * The time when the sun dial showing the sun display comes to the top position, is 12 o'clock noon. The time when it comes to the bottom position, is 12 o'clock midnight. The moon dial and the sun dial are identical with each other in the specifications including the rotating direction.

The inflow or outflow of the tide is learned from the moon's age display.

Moon's age: 0 (New moon) Spring tide	Moon's age: 7 Neap tide	Moon's age: 15 (Full moon) Spring tide	Moon's age: 22 Neap tide

- * The moon's age display is designed to show the moon's age and is not designed to show the moon's phases.

- The moon's age... The moon's age is the time elapsed starting from the new moon, which is shown on a day basis. Particularly, the time elapsed until noon on a given day is called the meridian age of the moon. The moon's age carried in the newspaper is the meridian age of the moon.

In this watch, both the moon's age display (showing the phase and position of the moon) and the sun display (showing the position of the sun) function in relation with the movement of the hands.

Set the time by turning the crown clockwise or counterclockwise with the crown remaining pulled out to the second clicking position. At this moment, pay attention to the sun display (the position of the sun).

The method for setting the moon's age display is described below, which is available in two ways: a) The general method and b) The method by way of quick correction. It may be convenient for you if you use the right way in the right place.

Installation of the sun display has been carried out adjusting it to the time, and thus the local adjustment is not necessary for the sun display.

3) Method for setting the moon's age display
a. The general method

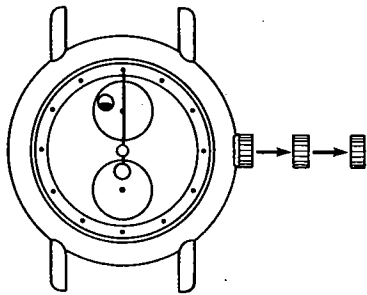

[The time is 12 o'clock noon]

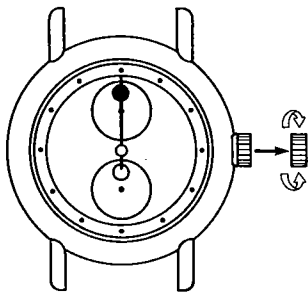

[The time is 12 o'clock noon at the moon's age of 0]

- ① Pull the crown out to the second clicking position. Then, the second hand stops running.
- ② Set the hour and minute hands and the sun dial to the 12 o'clock noon position (the top position) by turning the crown clockwise or counterclockwise.
 - Whether the time belongs to a.m. or p.m. is confirmed by the position of the sun.

If the sun display is at the top position, the time is 12 o'clock noon.

If the sun display is at the bottom position, the time is 12 o'clock midnight.
- ③ Place the crown in the first clicking position.
- ④ Turn the crown clockwise or counterclockwise so that the moon dial will display the new moon (or the conjunction...the state in which the moon is not seen from the earth).
- ⑤ With the moon dial display remaining as the new moon, set the moon dial to the 12H position (the top position). At this moment, the time is 12 o'clock noon at the moon's age of 0.
- ⑥ Confirm today's moon's age
 - The moon's age of a given day or the following day is sometimes carried in the weather forecast column of the regional page of the newspaper of the day. Please refer to it.

When setting the moon's age display referring to the moon's age of the following day, subtract the moon's age for one day from the moon age of the following day.

Count fractions of .5 and over as a unit and cut away the rest.

Example) The moon's age of the following day: 5.3

$$5.3 - 1 = 4.3 \rightarrow 4$$

The moon's age of a given day comes to 4.

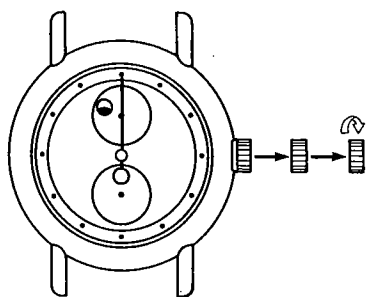

- ⑦ Place the crown in the second clicking position.
- ⑧ Turn the crown clockwise so that the sun dial will turn clockwise starting at the 12 o'clock noon position (the top position). Turn the sun dial the number of times equivalent to the moon's age and adjust it to the 12 o'clock noon position.

Example)

In case the moon's age of a given day is 4:

Pull the crown out to the second clicking position. By turning the crown clockwise, turn the sun dial 4 times starting at the 12 o'clock noon position (the top position) and adjust it to the 12 o'clock noon position (the top position).

At this time, the moon's age display indicates 12 o'clock noon at the moon's age of 4.

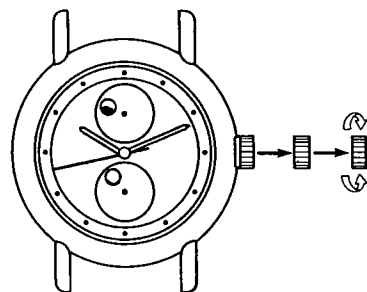

- ⑨ Set the hands to the current time with the crown remaining pulled out to the second clicking position.
- ⑩ If the crown is pushed back into the normal position, the watch starts to keep time.

b. The method by way of quick correction

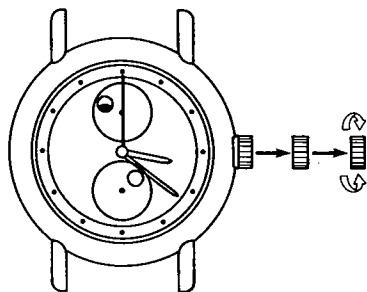

- ① Confirm the moon's age of a given day.
 - * Refer to the No. 6 of the preceding item a) The general method.
- ② Confirm when the moon culminates at the moon's age of a given day referring to the "Timetable of the moon's culmination" which is attached in a separate sheet.
- ③ Pull the crown out to the second clicking position and set the hands to the time when the moon culminates.
 - * Pay attention to whether the time belongs to a.m. or p.m. (the position of the sun display).

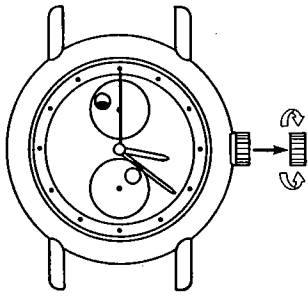

- ④ Place the crown in the first clicking position.
Turn the crown clockwise or counterclockwise so that the moon dial will display the new moon (conjunction) and adjust the moon dial to the top position.

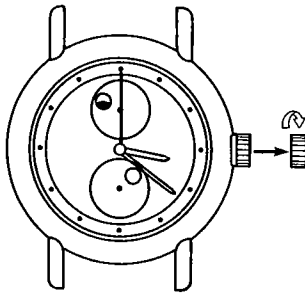

- ⑤ With the crown remaining pulled out in the first clicking position, turn the crown clockwise so that the moon dial will turn clockwise. Turn the moon dial the number of times equivalent to the moon's age of a given day and then adjust the moon dial to the top position. The number of times of turning the moon dial is obtained from the "Timetable of the moon's culmination".

* At this moment, the time when the moon culminates on the given day is indicated.

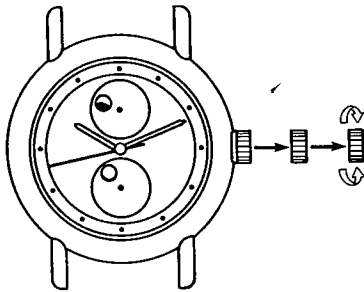

- ⑥ Place the crown in the second clicking position. Then set the hour, minute and second hands to the current time.
- ⑦ If the crown is pushed back into the normal position, the watch starts to keep time.

*The moon's phase and the position of the sun and the moon shown on this watch may slightly differ from the reality due to the nonuniform motion of the sun and the moon and the difference between the longitude at the given place and the longitude where the standard time is kept.

Accordingly, use the display shown on the watch as a standard.

Timetable of the moon's culmination

The meridian age of the moon	Time when the moon culminates	Number of times of turning the moon dial	The meridian age of the moon	Time when the moon culminates	Number of times of turning the moon dial
0	12 hr. 00 min.	0	15	—	—
1	12 hr. 50 min.	1	16	0 hr. 37 min.	15
2	13 hr. 41 min.	2	17	1 hr. 28 min.	16
3	14 hr. 31 min.	3	18	2 hr. 18 min.	17
4	15 hr. 22 min.	4	19	3 hr. 08 min.	18
5	16 hr. 12 min.	5	20	3 hr. 59 min.	19
6	17 hr. 03 min.	6	21	4 hr. 49 min.	20
7	17 hr. 51 min.	7	22	5 hr. 40 min.	21
8	18 hr. 44 min.	8	23	6 hr. eo min.	22
9	19 hr. 34 min.	9	24	7 hr. 21 min.	23
10	20 hr. 25 min.	10	25	8 hr. 11 min.	24
11	21 hr. 15 min.	11	26	9 hr. 02 min.	25
12	22 hr. 06 min.	12	27	9 hr. 52 min.	26
13	22 hr. 56 min.	13	28	10 hr. 43 min.	27
14	23 hr. 47 min.	14	29	11 hr. 33 min.	28

*When the moon's age is 15, set the moon dial to the age before or after 15, namely 14 or 16 and then correct it at a later period by advancing or turning back by 24 hours.

*When the moon's age is beyond 29.5, set the moon dial to the age of 0.

§4. NOTES ON DISASSEMBLY AND ASSEMBLY

●How to remove day dial gib (Cal 2000*/2100*)

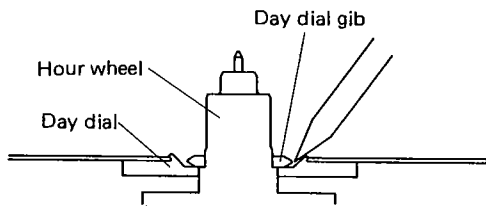

As illustrated left, a thin driver is put into a gap and then pried gradually the day dial gib for removal.

●How to set day dial (Cal 2000*/2100*)

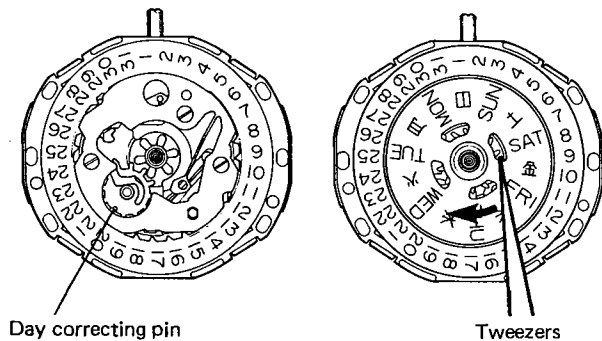

When setting the day dial, the day correcting pin attached to the date dial driving wheel must be set first at the outside position (toward the date dial).

Then as illustrated left, the day dial is set and a tweezers is put into a hole of the day dial. Under such conditions, the day dial is turned toward the arrow mark while being pressed down with the tweezers.

●Setting/unsetting of calendar plate

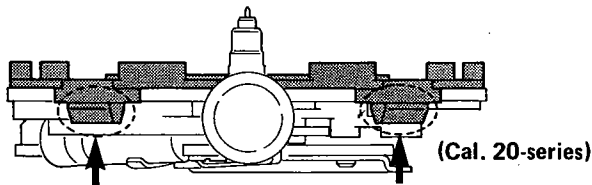

The calendar plate is fixed to the plate complete via the hooks at four areas.

When removing the calendar plate, the areas shown by two arrows (upper left diagram) are pried gradually by a driver.

The hook parts are removed, when necessary, at the two areas toward the setting stem. All hooks can be removed by removing first the above-mentioned two hooks.

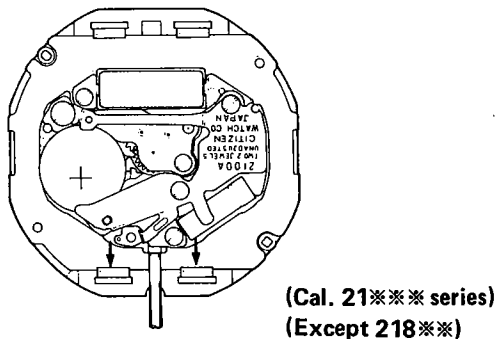

When setting the calendar plate, the hook parts of the setting stem side must be first set. Then the hook parts of the opposite side are pressed for fixing.

* Avoid pressing all hook parts at a time to prevent shaving the hook parts. (Cal. 21-series)

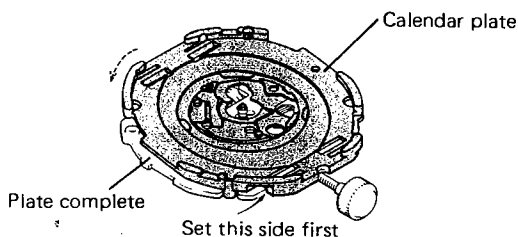

Set this side first

● Setting/unsetting of power cell

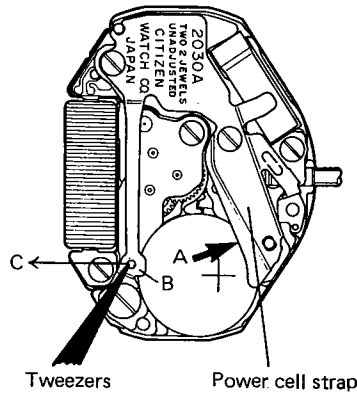

When setting the power cell, the area of the power cell indicated by the arrow A is put first under the power cell strap. Then the opposite side of the power cell is pressed down. Thus the part B of the power cell strap fixes the power cell tight.

The power cell is unset by putting the tip of a tweezers into the hole at the part B and then pushing the spring part toward the arrow C.

Be careful enough not to touch the coil unit with the tweezers.

● Setting of power cell strap

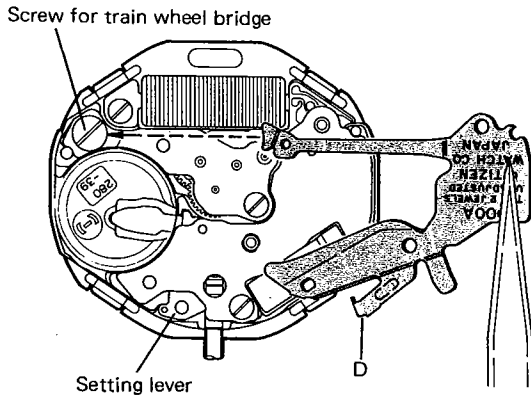

The tip of the spring part of the power cell strap is put under the screw (with stages) for train wheel bridge before setting the power cell strap.

After setting, make sure that the tip of the part D is holding the setting lever tight and completely.

If the setting lever is floating up, the setting stem will come off.

● Contact of power cell strap

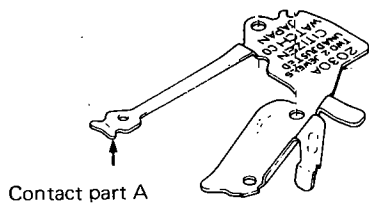

- A contact between the power cell and the power cell strap is duly secured at a contact part A in the left diagram.

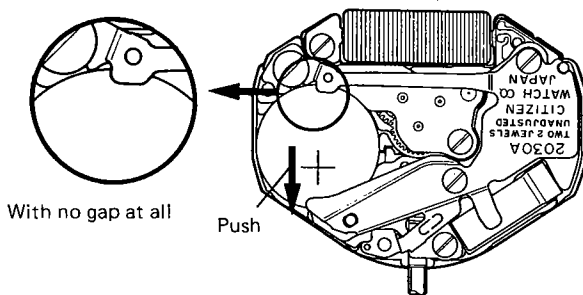

- After setting the power cell, push the power cell to the direction opposite to the part A. In this case, make sure that a complete contact is obtained between the power cell and the part A with no gap at all. An unsteady contact will cause a temporary stop of the watch operation.

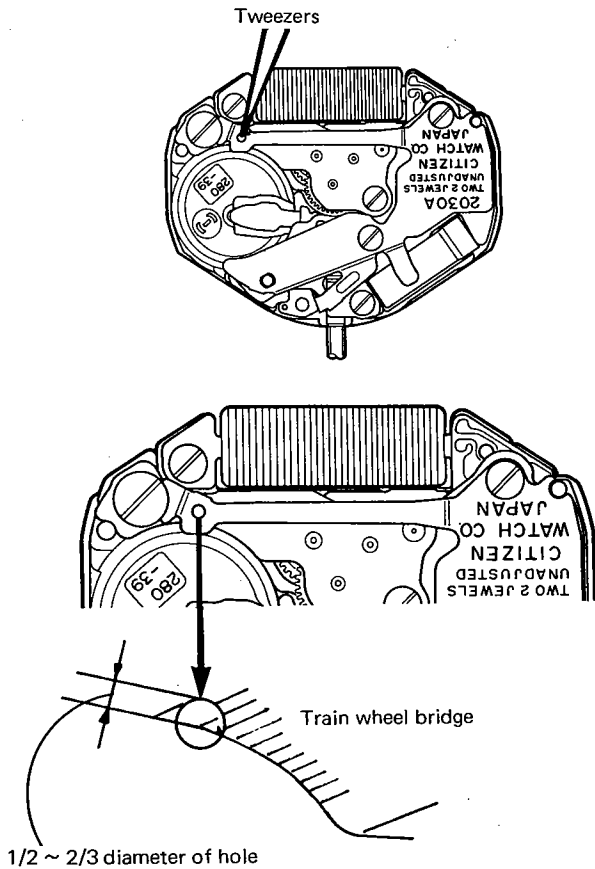

- If some gap exists between the power cell and the part A, put a tweezers into a hole at the tip of the power cell strap and bend the strap toward an arrow as illustrated left.

The power cell strap must not be bent with strong force and at once but must be bent gradually.

- The contact part of the power cell strap is best positioned at about 1/2 ~ 2/3 diameter of the hole at the tip of the strap, where the train wheel bridge can be viewed.

• Setting of yoke

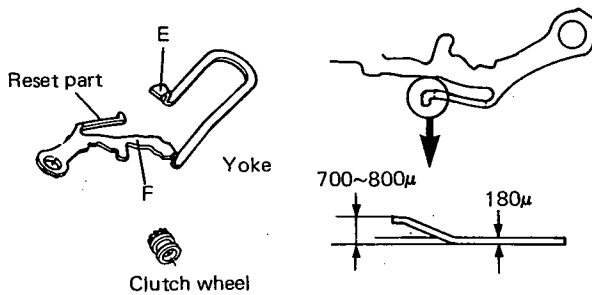

The yoke is set by putting the part F into the groove of the clutch wheel after setting the yoke to the setting lever. Then the part E is slid under the center wheel cock to secure a steady setting of the yoke as a whole.

*The bending height of the reset part is optimum in a range of 700 ~ 800μ. (Compare with the thickness of the yoke of about 180μ as a standard.)

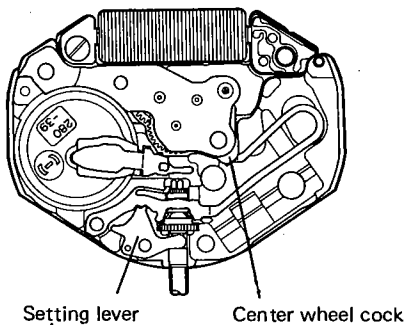

In this caliber, the reset part of the yoke functions as the conventional resetting lever.

• Notes on Replacement of Setting Stem

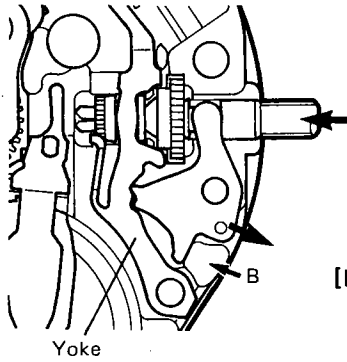

[Fig. 1]

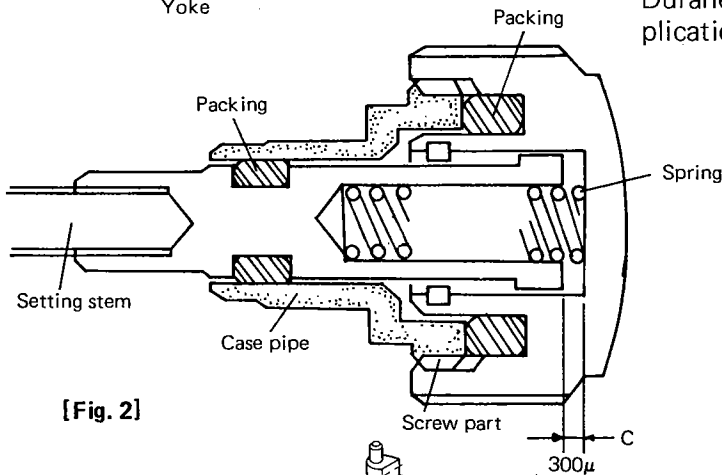

[Fig. 2]

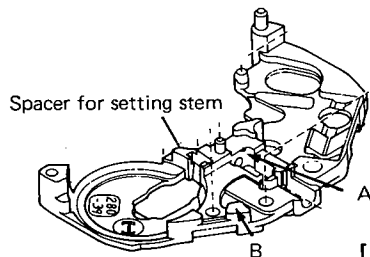

[Fig. 3]

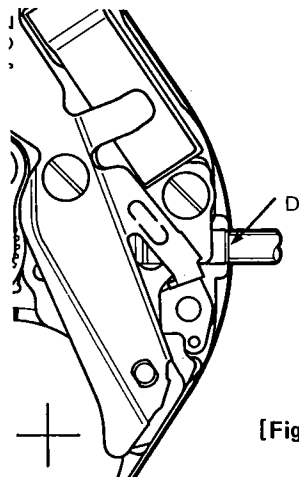

[Fig. 4]

A water-resistant model for a high atmospheric pressure is planned in this caliber. And a particular attention must be paid to a replacement of the setting stem for a model that uses a screw locking type crown.

The stopper, which prevents the setting stem from going inside more than toward its normal position, prevents an outward movement of a setting lever at the part B in Fig. 1.

The stopper part (spacer for setting stem) is made of Duranex and thus may possibly be crushed with application of an intensive force.

The crown is screw-locked in Fig. 2. Gap C of about 300μ is secured although the crown is locked.

Thus no trouble arises at all if the length of the setting stem is increased by an amount equivalent to the gap C. However if this amount of increase exceeds the gap C, the setting stem will be pressed toward the movement. With more increase of the length of the setting stem, the setting stem will break the stopper and go into the movement.

(In this case, the corner part of the spacer for setting stem off the part A in Fig. 3 to go into the movement.)

* This results in a reset mode to stop the watch operation.

(The setting lever pushes the yoke to actuate the reset function.)

(Method of confirmation)

1. The position of part D of a setting stem must not go inside excessively when a crown is locked with the case back removed and the crown set at its normal position. (Fig. 4)
2. The operation of a complete watch must not be stopped when the crown is locked. (This checking must be repeated several times.)

- The train wheel of the dial side mechanism should be exactly mounted as illustrated below.
(Cal. 2180※)

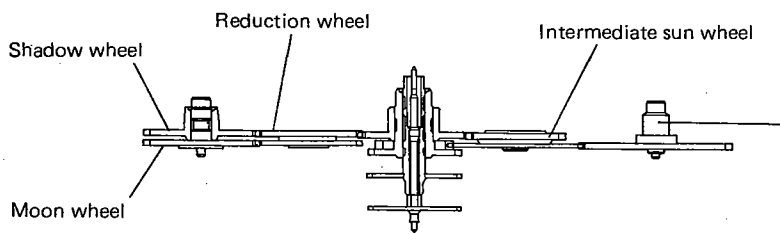
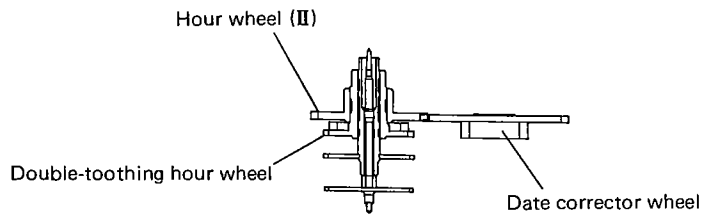

* Mount the reduction wheel with the gold gears facing downward.

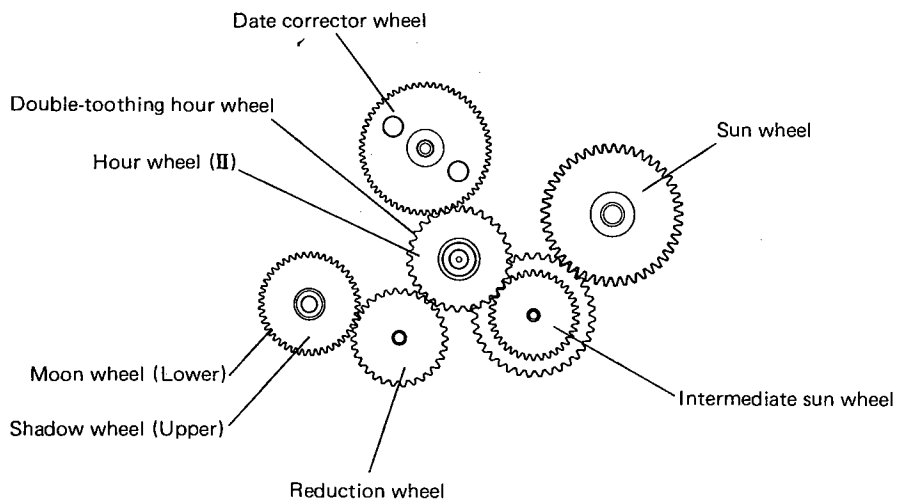

55. DISASSEMBLY AND ASSEMBLY OF APPEARANCE PARTS

● Cal. 218**

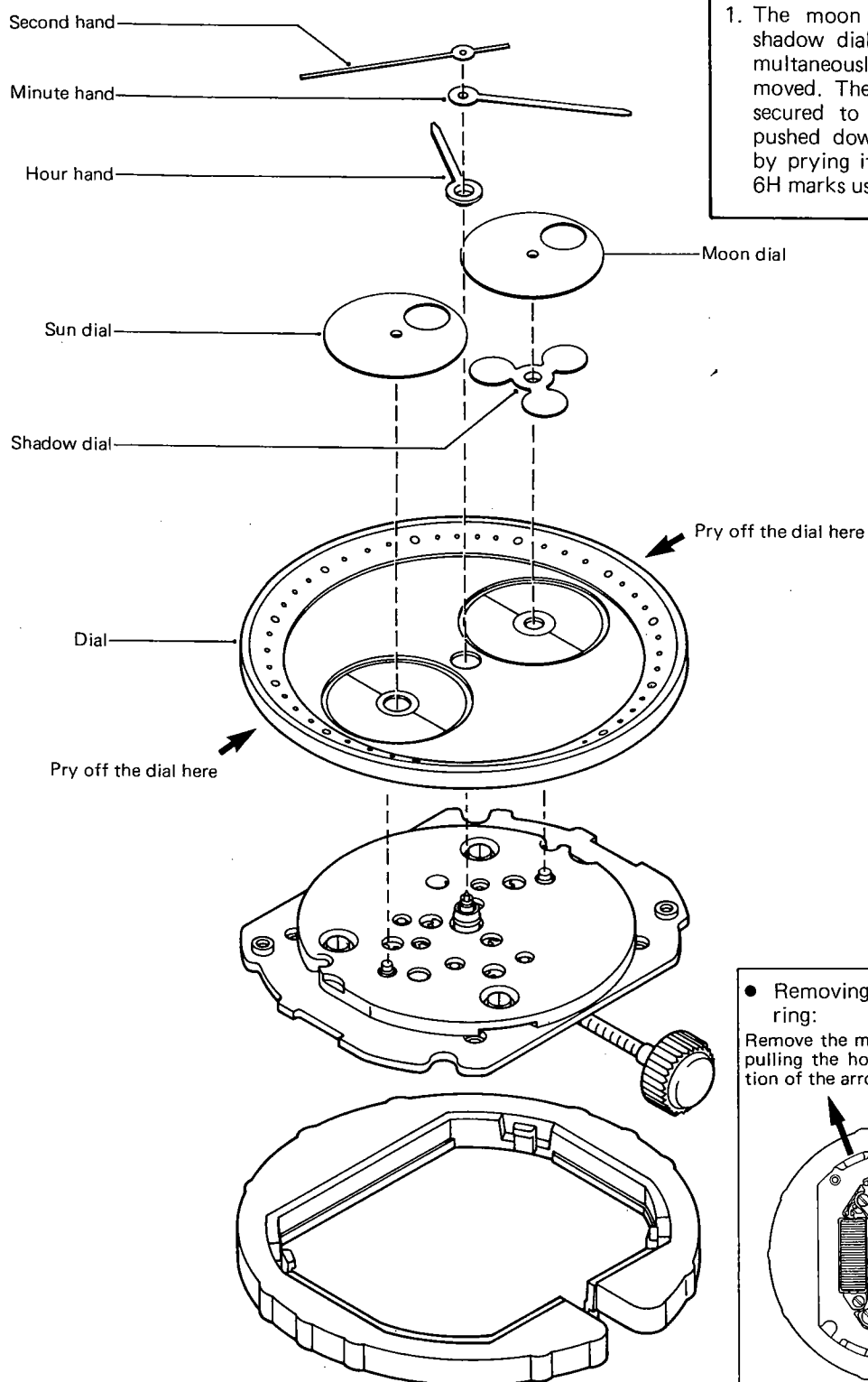

1. The moon dial, sun dial and shadow dial are all removed simultaneously when the dial is removed. The foot of the dial is secured to the module if it is pushed down. Remove the dial by prying it off at the 12H and 6H marks using the tweezers.

● Removing the movement holder ring:

Remove the movement holder ring while pulling the hook outward (in the direction of the arrow) using the tweezers.

§ 5. DISASSEMBLY/ASSEMBLY OF MOVEMENT

● CAL 20※※※/21※※※ (Except 218※※)

Disassembling procedure: ① → ③①

Assembling procedure: ③① → ①

*Both 20- and 21-series watches follow the same procedure of disassembly and assembly. See page 6 for the disassembly and assembly at the dial side of Cal. No. 2040A.

Marks of lubrication

- ⊗ A-Lube oil
- ∇ V-Lube oil
- ⊙ F-Lube oil
- ∞ CH-1 oil

How to remove setting stem

The setting stem is removed with the crown set at its normal position and by pushing with a tweezes the area indicated by an arrow in the diagram below.

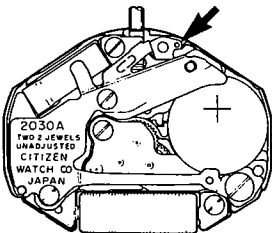

How to remove dial

The gaps are secured for the dial at the positions indicated by the arrows in the diagram below. A driver or the like is put into these gaps and then pried them alternately to remove the dial.

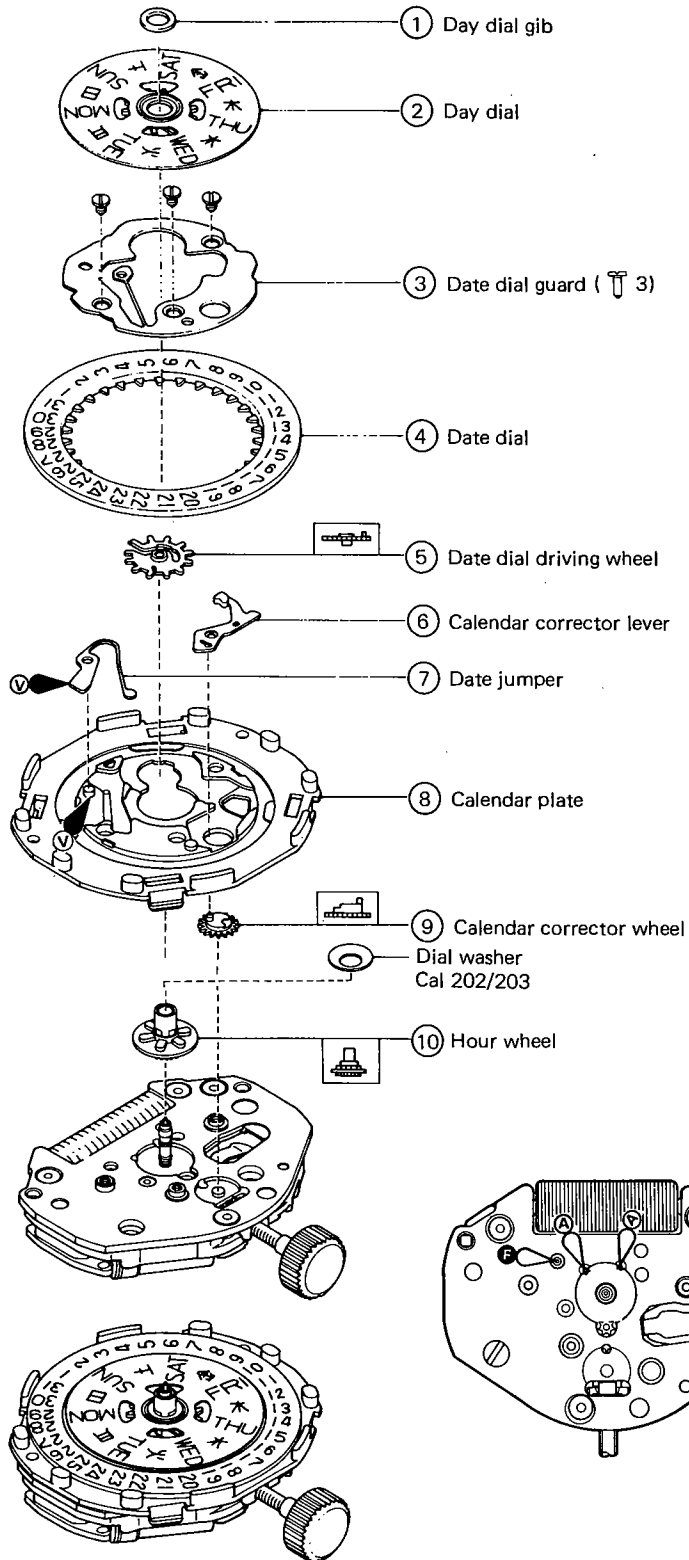

<CAL. 204**>

(with small second)

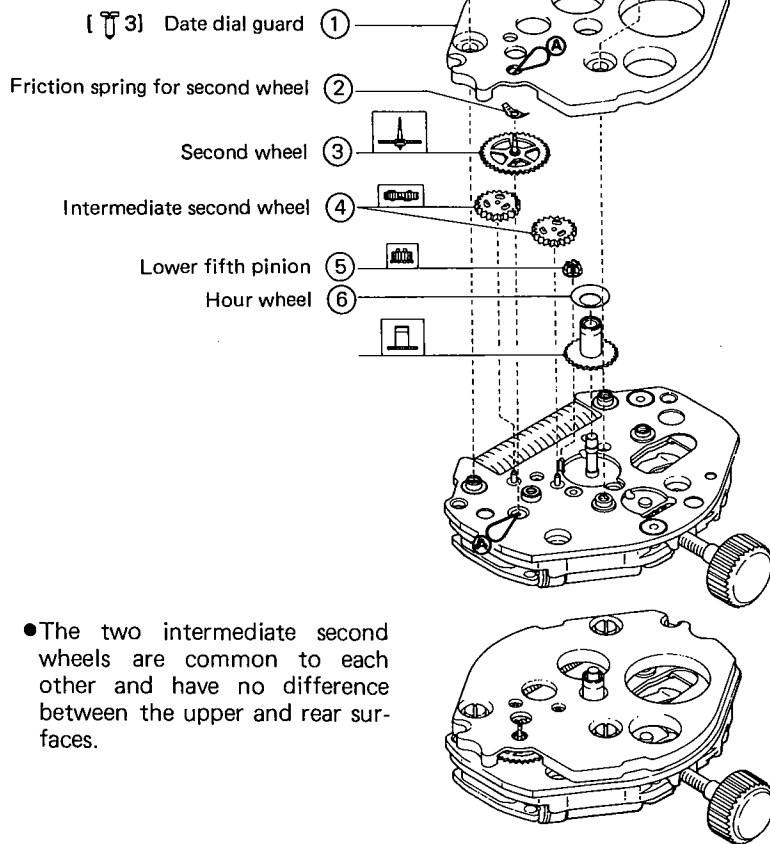

•The two intermediate second wheels are common to each other and have no difference between the upper and rear surfaces.

● Setting of lower fifth pinion

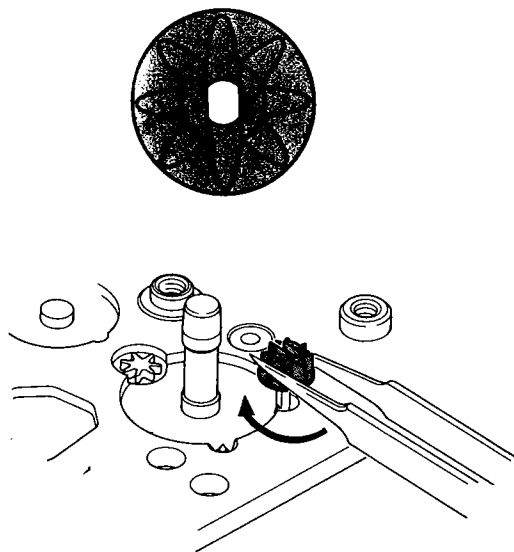

The lower fifth pinion has a hole of such shape as shown in the left diagram in order to avoid the slipping with the core of 5th wheel. The core of 5th wheel has also the same shape. The lower fifth pinion is put soft on the core of 5th wheel, and at the same time the movement is turned. Thus the pinion will fit completely to the core.

The lower fifth pinion is made of resin and accordingly must be held soft. And be careful not to miss the pinion since it is very small in size.

<CAL. 214**>

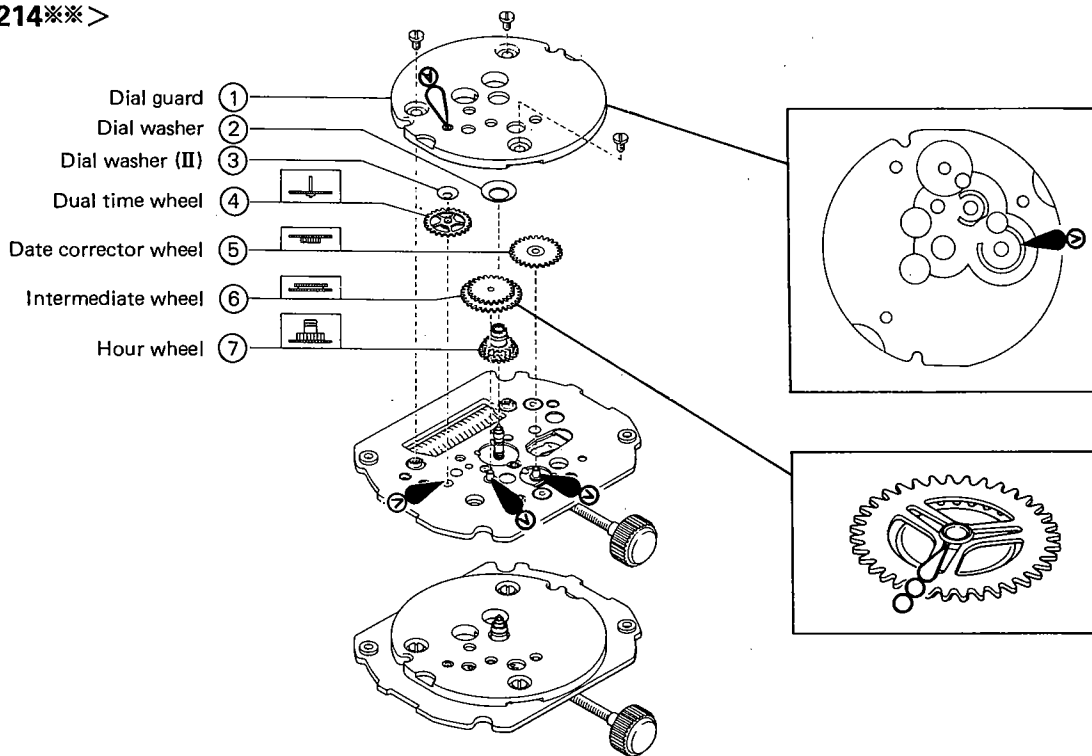

<CAL 218***>

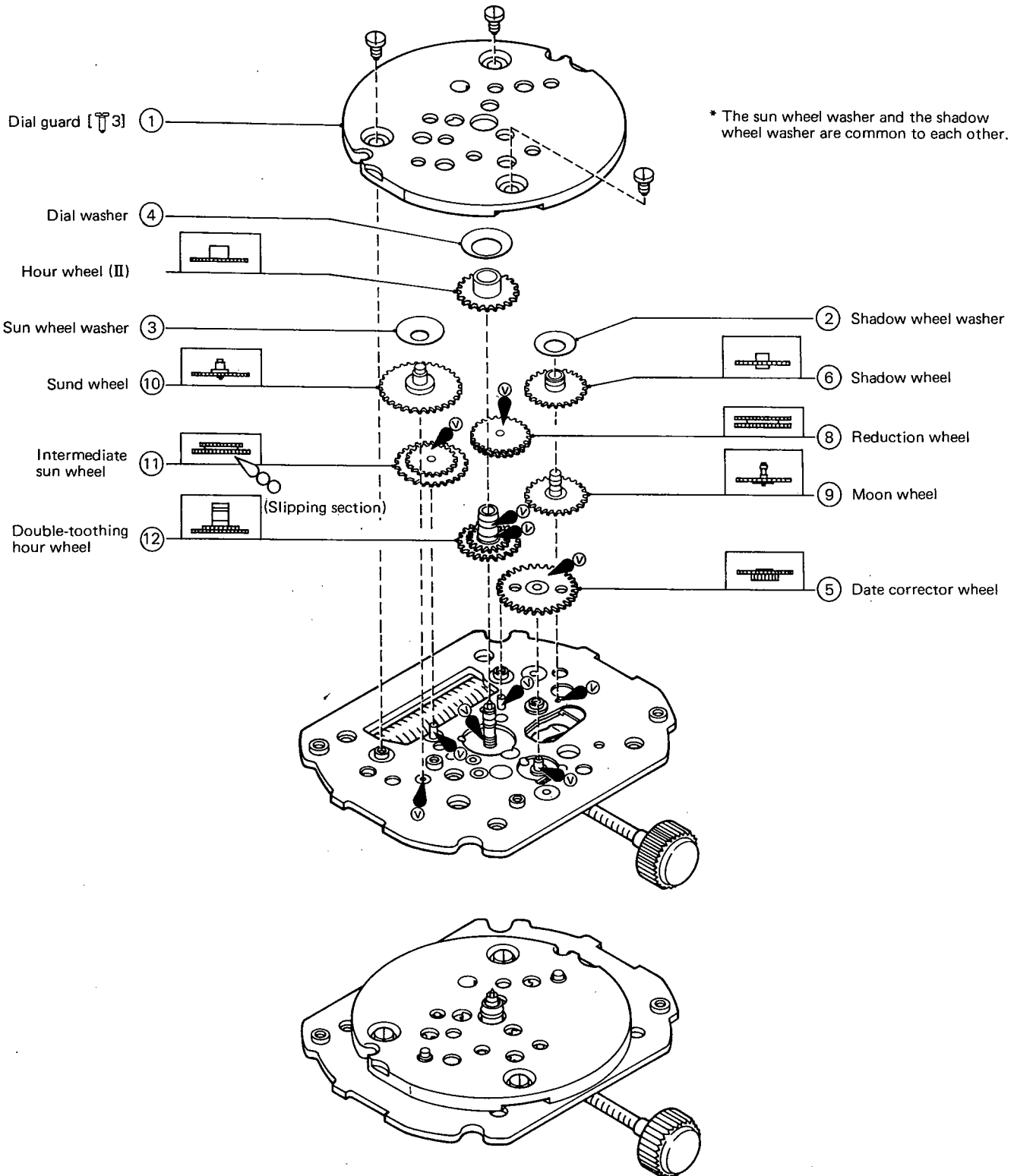

●Common to Cal. 20***/21***
4th wheel and pinion

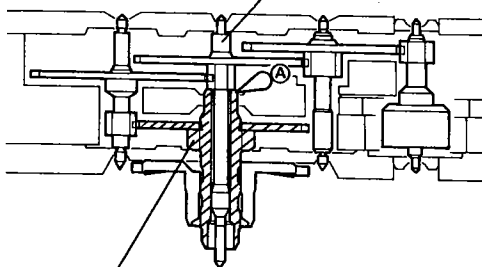

Cannon pinion with driving wheel

The A-Lube oil is also supplied to the lower face of the 4th wheel's pinion. (This is to avoid wearing down the cannon pinion with driving wheel.)

●Cal.20*** and Cal.21*** are slightly different from each other in its shape of the plate complete, however both are identical to each other in the disassembling and assembling procedures.

●Nos. (11) to (30) in the disassembling and assembling procedures of Cal.20***/21*** are changed to (13) to (32) in Cal. 2180*.

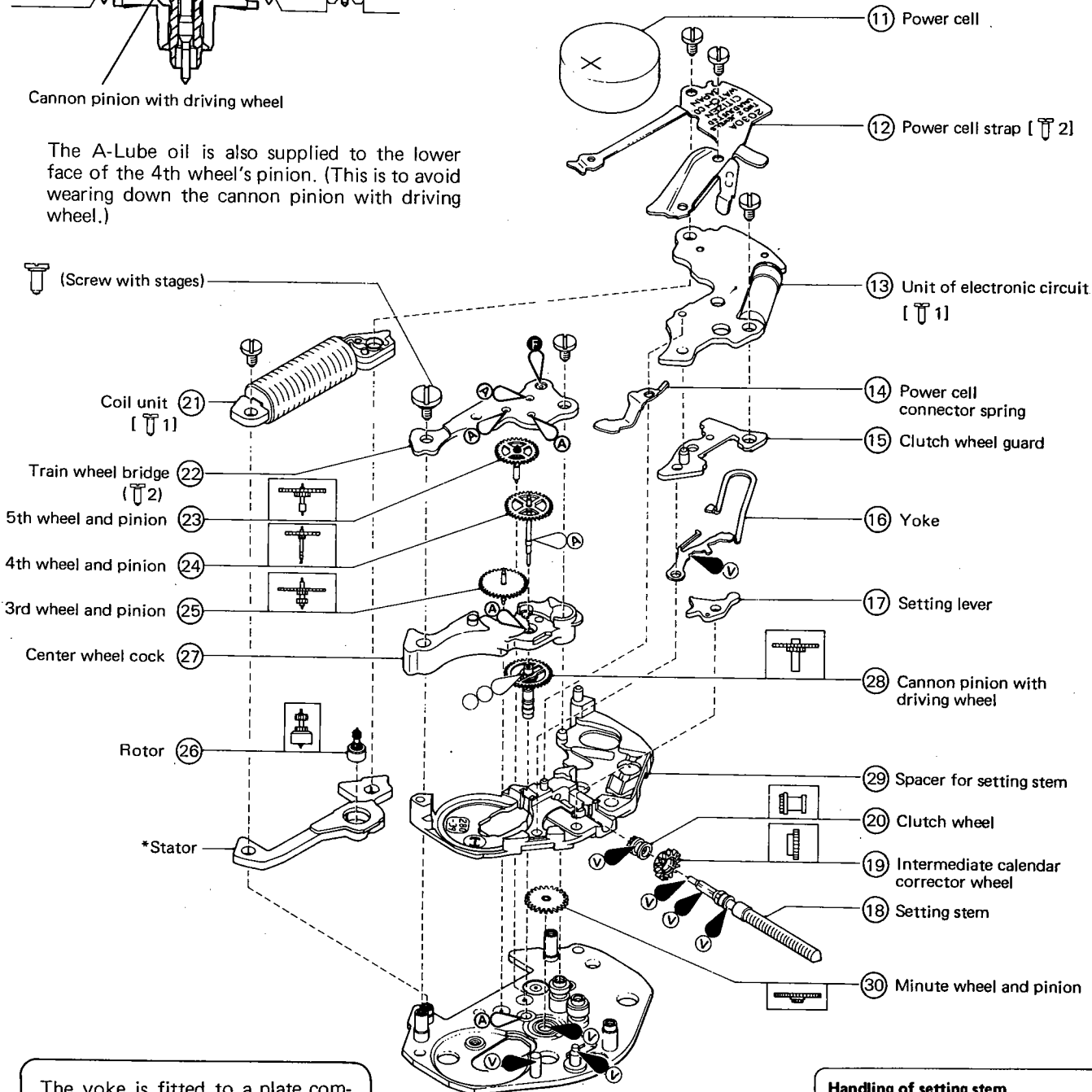

The yoke is fitted to a plate complete rather tight or loose according to each type of the watch. It is usually not required to unset the yoke. If the yoke comes off during the disassembly, it must be set before setting the center wheel cock.

Handling of setting stem
The setting stem is fixed completely with a setting of the power cell strap. Thus a pull-out of the setting stem must be avoided before setting the power cell strap. And the disassembly/assembly must be carried out with the setting stem pushed completely back to its normal position.

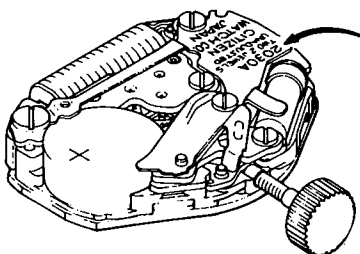

6. TROUBLESHOOTING AND ADJUSTMENT (Common to 20❖❖❖/21❖❖❖)

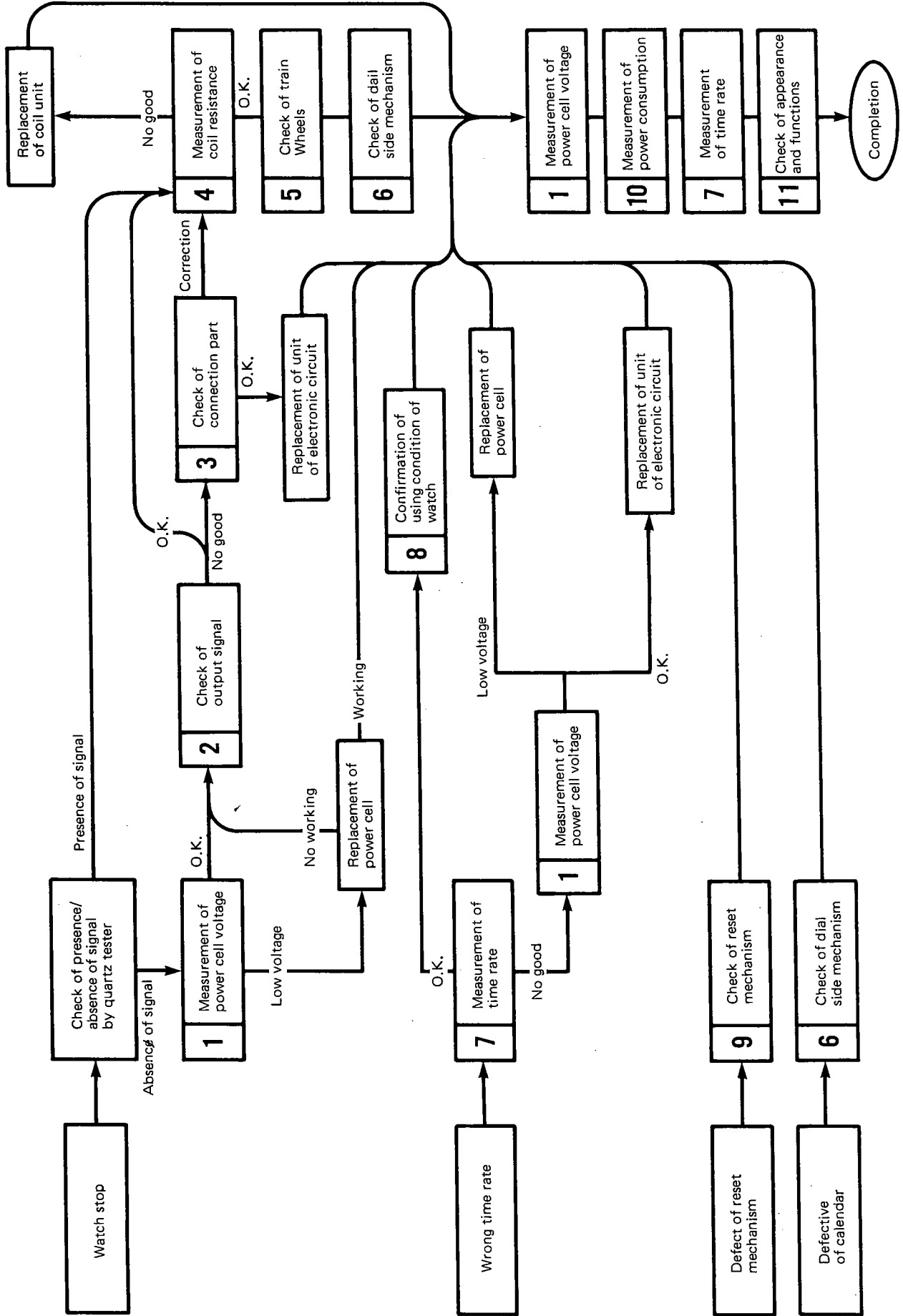

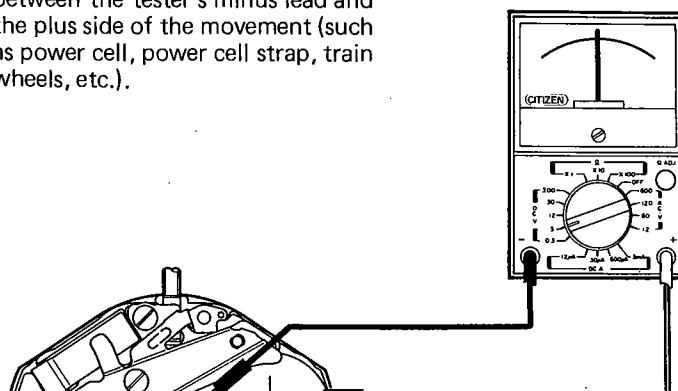
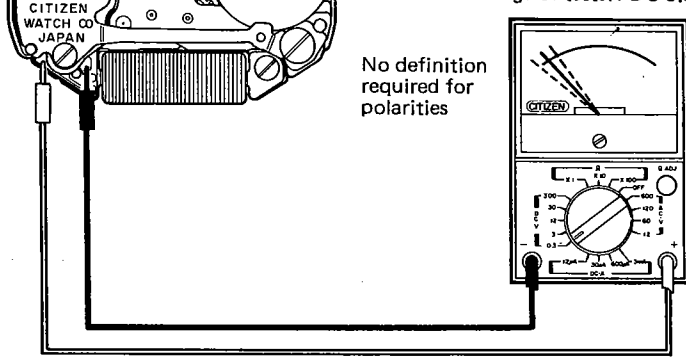
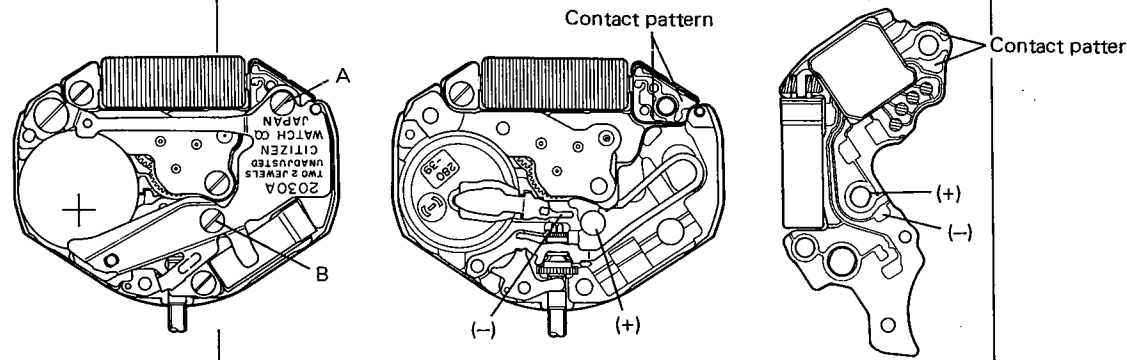
Checking items	How to check	Result and treatment
<p>1 Measurement of power cell voltage</p>	<p>Be careful to avoid a short circuit between the tester's minus lead and the plus side of the movement (such as power cell, power cell strap, train wheels, etc.).</p> <p>Range of tester: DC-3V</p> 	<p>Over 1.5V</p> <p>→ Nondefective</p> <p>Under 1.5V</p> <p>→ Replacement of power cell</p>
<p>2 Confirmation of output signals</p>	<p>No definition required for polarities</p> <p>Range of tester: DC-0.3V</p>  <p>The output signal is nondefective if the tester's pointer swings right and left every second and centering on 0.</p>	<p>Be careful not to cause a short circuit to the tester's lead terminals with other areas of the movement nor to give flaws to the coil.</p>
<p>3 Check of connection part</p>	<p>1) Make sure that both screws A and B are driven tight and completely.</p> <p>The screw A secures the contact pressure at the connection part between the coil terminal and the unit of electronic circuit.</p> <p>The screw B is at the area where the voltage (+) is supplied to the unit of electronic circuit through the tube by which the screw is tightened. The power source (-) is also provided near the (+).</p> <p>2) Makes sure that the contact patterns of both the coil and the unit of electronic circuit are free from any dust or stains.</p> <p>Also make sure that no dust nor stains attached to (+) and (-) patterns as well as to the area of contact between the both patterns.</p> 	<p>Loose screw</p> <p>→ To be driven again</p> <p>Dust or stains</p> <p>→ To be cleared away</p> <p>No defect detected</p> <p>→ Replacement of unit of electronic circuit</p>

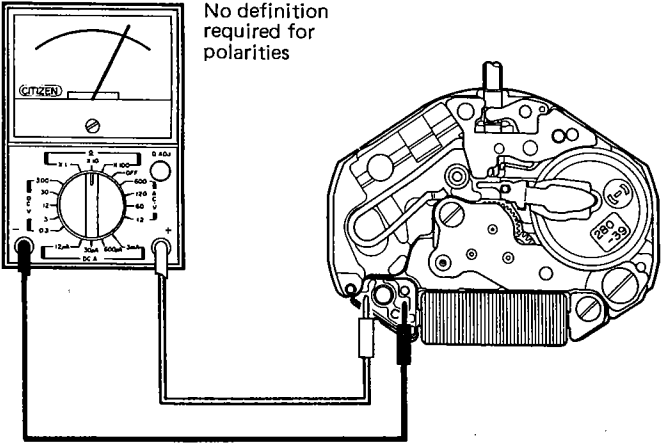
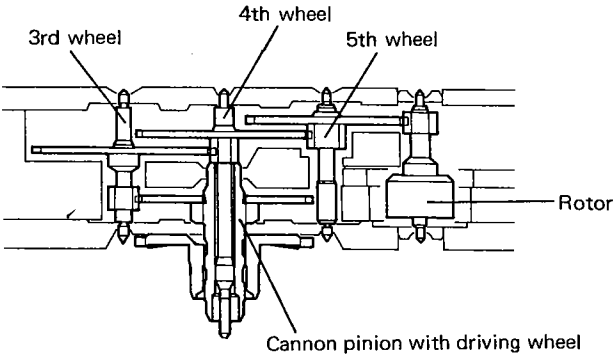
Checking items	How to check	Result and treatment
<p>4 Measurement of coil resistance</p>	<p>The coil resistance is measured with the unit of electronic circuit removed.</p> <p>Range of tester: R x 10Ω</p>  <p>No definition required for polarities</p>	<p>Watch with calendar (Inc. Cal. 2140)</p> <p>1.9 ~ 2.4 kΩ</p> <p>→ Nondefective</p> <p>Watch with no calendar (Except Cal. 2140)</p> <p>2.8 ~ 3.4 kΩ</p> <p>→ Nondefective</p> <p>Value outside above ranges</p> <p>→ Replacement of coil unit</p>
<p>5 Check of train wheels</p>	<ol style="list-style-type: none"> 1) Make sure that a proper clearance is secured for each gear wheel. 2) Make sure that the lubrication is appropriate for each wheel. 3) Make sure that each wheel is completely free from dust or stains.  <p>3rd wheel</p> <p>4th wheel</p> <p>5th wheel</p> <p>Rotor</p> <p>Cannon pinion with driving wheel</p>	
<p>6 Check of dial side mechanism</p>	<ol style="list-style-type: none"> 1) Make sure that a turning of hands is possible in the normal way and that a smooth change over is possible between the date and day displays. <p>In case some defect is detected, the following points are confirmed.</p> <ul style="list-style-type: none"> • Each of the minute wheel and pinion, the hour wheel and the date dial driving wheel is free from any malformation. • Each spring part of the day jumper and the date dial guard is free from any malformation. • Both the date and day dial have no warp nor creak. 	<p>Heavy turning of hands</p> <p>→ Lubrication of CH-1 oil to cannon pinion with driving wheel</p> <p>Malformation</p> <p>→ Replacement of deformed parts</p>

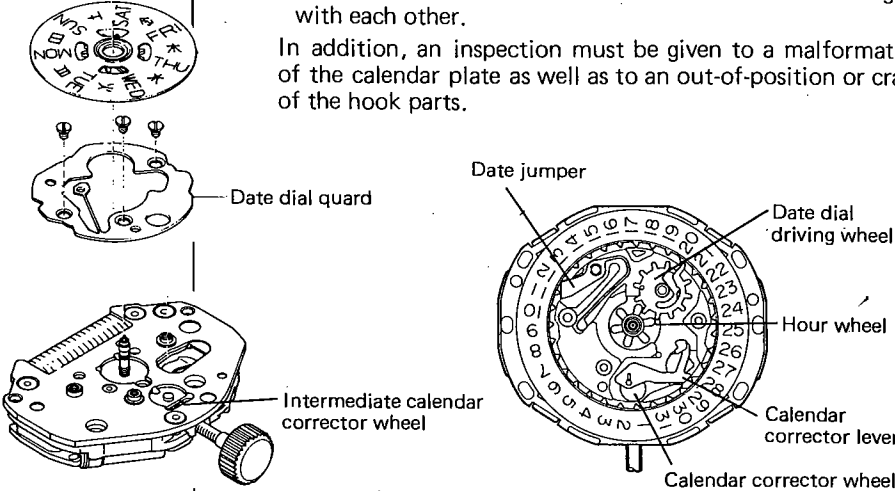
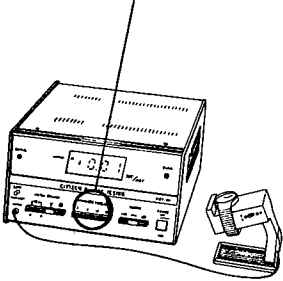
Checking items	How to check	Result and treatment
	<p>2) A quick setting operation is confirmed.</p> <p>In case some defect is detected, the following points are checked.</p> <ul style="list-style-type: none"> •The calendar corrector lever has no malformation and does not get out of position. •Both the calendar corrector wheel and the intermediate calendar corrector wheel have no malformation and engage with each other. <p>In addition, an inspection must be given to a malformation of the calendar plate as well as to an out-of-position or crack of the hook parts.</p>	
<p>7 Measurement of time rate</p>	<p>The unit time of measurement must be set at <u>"10 sec." or an integer-fold value of 10 sec. owing to the DFC method.</u></p> 	<p>Big error detected in time rate</p> <p>→ Replacement of unit of electronic circuit</p>
<p>8 Check of using condition of watch</p>	<p>The following points are checked for a watch with its user.</p> <ol style="list-style-type: none"> 1) Make sure whether the watch has been used at an extremely high or low temperature. 2) Make sure whether the watch has received a severe shock. 3) Make sure whether the watch has been affected by the magnetism. 4) How many days have passed since the watch received the final adjustment of time rate? 	

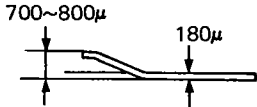
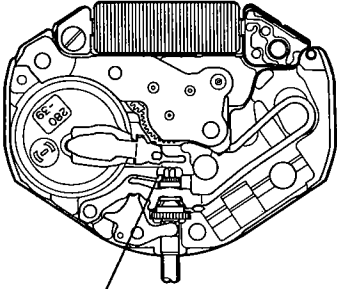
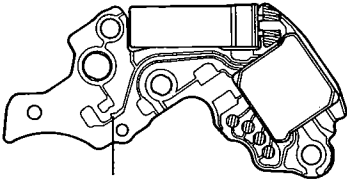
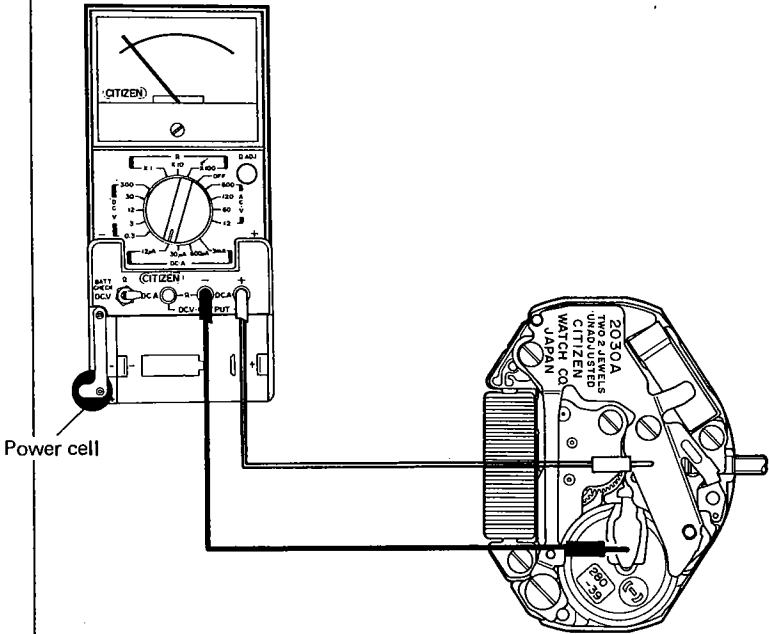
Checking items	How to check	Result and treatment
<p>9 Check of reset mechanism</p>	<p>The wear or breakage is examined for the reset part of the yoke.</p> <div data-bbox="410 384 1105 611" style="border: 1px solid black; padding: 5px;"> <p>The bending height at the tip of the reset part must be set at a range of 700 ~ 800μ.</p>  </div> <p>Make sure that the tip of the reset part or the reset pattern is free from any dust or stains.</p> <div style="display: flex; justify-content: space-around; align-items: center;">   </div> <p style="text-align: center;">Reset part Reset pattern</p>	<p>Breakage of reset part → Replacement of yoke</p> <p>Wear of reset part → Correction or replacement of yoke</p> <p>Dust or stains → To be cleared away</p>
<p>10 Measurement of power consumption</p>	<p>Range of tester: DC 12μA or 30μA</p> <div style="display: flex; align-items: center;">  </div> <p style="margin-left: 20px;">Power cell</p> <div style="border: 1px solid black; padding: 5px; margin-top: 10px;"> <p>Note: The power consumption will increase with actuation of the load compensating circuit if the train wheels and others have some creak and although the watch is working. The value of power consumption is about 2.5μA with actuation of the load compensating circuit. In such case, an overhaul is given to carry out again a measurement of power consumption.</p> </div>	<p>Watch with calendar (Inc. Cal. 2140)</p> <div style="border: 1px solid black; padding: 2px; display: inline-block;"> <p>Under 1.5μA</p> </div> <p>→ Nondefective</p> <p>Watch with no calendar (Except Cal. 2140)</p> <div style="border: 1px solid black; padding: 2px; display: inline-block;"> <p>Under 1.3μA</p> </div> <p>→ Non defective</p> <p>*Value other than above levels → Measurement of power consumption after overhaul with lubrication</p> <p>And then:</p> <div style="border: 1px solid black; padding: 2px; display: inline-block;"> <p>Over 1.5μA (With calendar)</p> <p>Over 1.3μA (With no calendar)</p> </div> <p>→ Replacement of unit of electronic circuit.</p>

Checking items	How to check	Result and treatment
<p>11 Check of appearance and functions</p>	<p>Make sure that the surfaces of the dial and glass are free from any dust or stains.</p> <p>At the same time, an examination is given to the working condition of the second hand stopping device, the turning condition of hands and other functions.</p>	