

1. Outline

This is a microminiature quartz watch for ladies, featuring the world smallest (capacity) movement which is developed through the Citizen's superb technology along with its concerted efforts.

Thanks to such microminiature movement full of diversity, a wide variety of designing becomes possible. Thus this new ladies' quartz watch will enhance the Citizen brand image to be also suited to take its stand in the market of the high-class watches.

2. Features

- 1) The microminiature and thin-gage quartz oscillation type watch for ladies with high-class ornamental sense, featuring the 30-second hand movement with no center second.
Its movement features the world smallest capacity of 120mm³, along with the size of 7.0 x 9.0mm (maximum dia. 9.5mm ϕ), the thickness of 2.0mm[†] (incl. the power cell part) the case thickness: 3.1mm[†]
- 2) The hand setting is of the electromagnetic correction system by means of the push-button.

3. Specifications

Caliber No.	1500E-10	1501E-10
Movement	Size : 7.0 x 9.0 mm (Mechanical dia.) 9.5 mm ϕ (Maximum dia.) Thickness : 2.0mm (incl. power cell part)	
Accuracy	± 15 sec./month at normal temperature	
Oscillation	32,768 Hz	
Converter	Bipolar step motor (30-second hand movement)	
Integrated circuit	C/MOS-LSI (one unit)	
Effective temperature range	$\pm 0^{\circ}\text{C} \sim +60^{\circ}\text{C}$ ($32^{\circ}\text{F} \sim 140^{\circ}\text{F}$)	
Hand setting	Electromagnetic correction system by push-button	
Power cell (Power cell block)	Parts No. : 280-49 Cell code : SR610W (UASA)	Parts No. : 280-54 Cell code : DQV (TOSHIBA)
	Size : 6.8 ϕ x 1.0mm [†] Nominal voltage: 1.5V Capacity : 5.5mAH Life time : About 1.5 years	

* Points of Difference between Cal. Nos. 1500 and 1501

The space between hands plus the thickness of dial and hands are different between Cal. Nos. 1500 and 1501.

Owing to these changes, the working efficiency is more increased for disassembly and assembly of Cal. No. 1501. Furthermore Cal. No. 1501 adapts a new method by which the dial is fixed to the movement holder ring. This increases the variety of designs to be suited to the ultrahigh-class watches of Citizen.

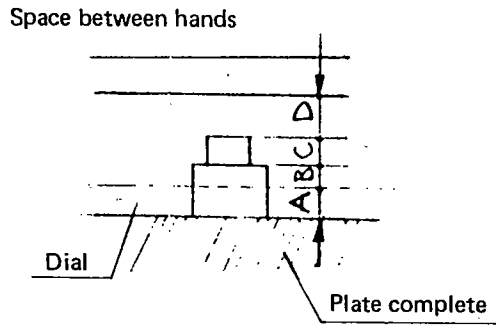

CAL NO.	1500E-10	1501E-10
A (thickness of dial)	50 μ	200 μ
B	140	220
C	160	250
D	120	150
Thickness of hour/ minute hands	40	100

★ Structure of Movement

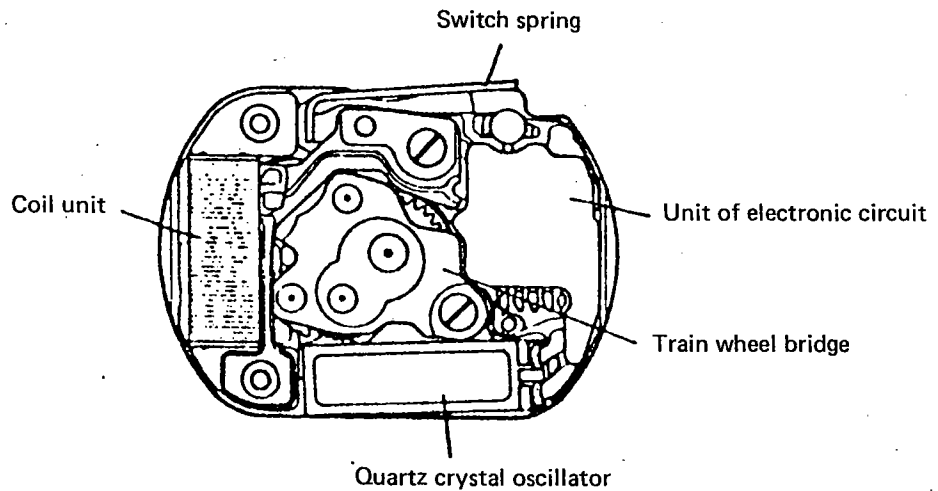

[Plan of movement without power cell block, power cell connector and power cell insulator.]

Power cells

The Cal. No. 1500 uses the power cell of 280-49; while Cal. No. 1501 uses the power cell of 280-54 respectively.

These two power cells differ from each other just in the markings provided on the power cell straps.

As listed below, two different types (Toshiba and Uasa) are available for the power cells. Notice that the polarity of a plate complete is negative (-).

<p>Cell of Toshiba</p>	<p>Cell code : DQV Composition : AgO/Na (Voltage non-control type)</p>
<p>Cell of Uasa</p>	<p>Cell code : SR610W Composition : Ag₂O/Na (Voltage non-control type)</p>

4. Handling Instructions

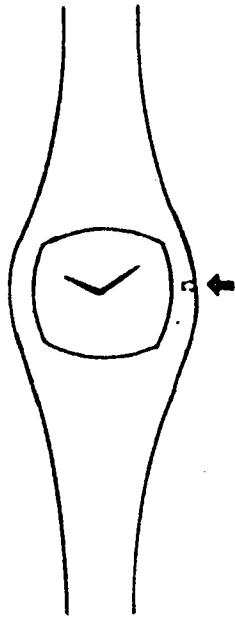

The time setting is carried out by pressing the push-button.



With push of the push-button, the hands advance forward.

In this case, the time equivalent to 30 seconds advances with every push of the push-button (repetition of push and release with 1-second interval). And in case the push-button is pressed continuously (1 second or more), the hands move continuously to secure the quick setting.

5. Main Tools and Jigs

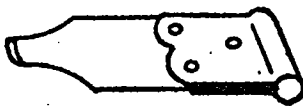
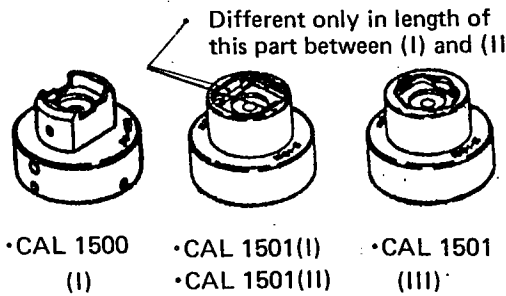
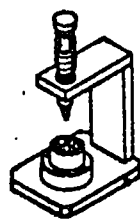
The following tools and jigs are provided for the Cal. No. 15-series watches. Choose proper one among these tools and jigs in accordance with the contents of application.

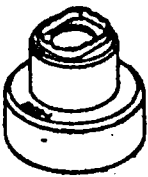
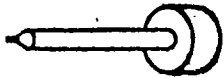
Tools/jigs	Form	Application
Pry opener		A pry opener exclusive for Cal. No. 790 is used.
Movement holder for attachment of hands	 <p>• CAL 1500 (I) • CAL 1501 (I) • CAL 1501 (III) • CAL 1501 (II)</p>	<ul style="list-style-type: none"> • three types are available for Cal. No. 1501 according to the form of the movement holding ring. • The height of a pin provided at the center of the movement holder can be adjusted by turning a screw on the back side of the holder with a driver.
Hand setting stand		

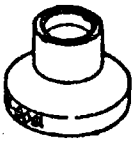
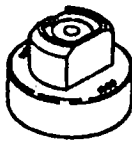
Tools/jigs	Form	Application
Movement holder for casing		Use this movement holder when setting the movement holding ring or the case body.
Hand setting rod		<p>Two types are available as follows.</p> <ul style="list-style-type: none"> • Hand setting rod with hole at tip for hour hand • Hand setting rod with no hole at tip for minute hand
Pushing rod for push-button		This rod is used when carrying out the adjustment of time rate with a complete watch for trouble-shooting and adjustment with a bezel only.
Hand remover		<p>This hand remover is common with Cal. No. 7900.</p> <p>Before use, apply the light buffing to the tip of the hand remover to avoid giving flaws to the dial or hands.</p>
Movement holder for replacement of power cell		This movement holder bears a marking "1500" and can be used in common with Cal. No. 1501.
Movement holder for disassembly/assembly		This movement holder also bears a marking "1500" and can be used in common with Cal. No. 1501.

6. Appearance Disassembly/Assembly

For the ring-type models, the screw for ring body is removed first to take out the case body.

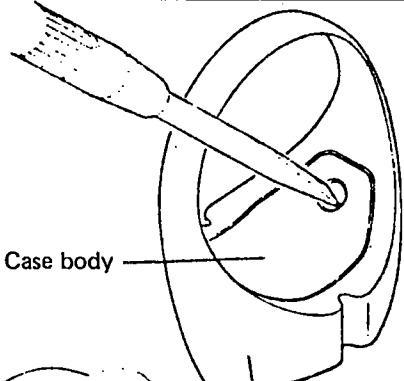
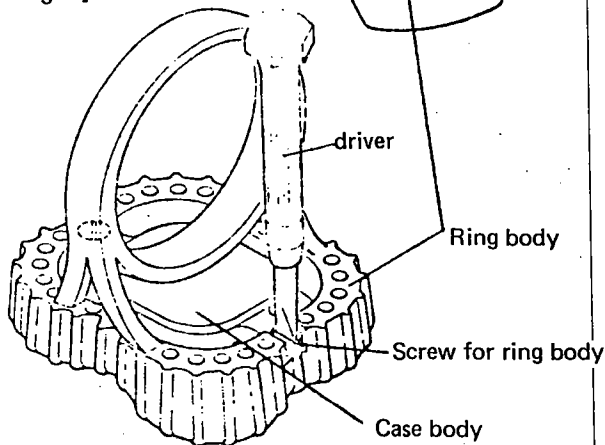
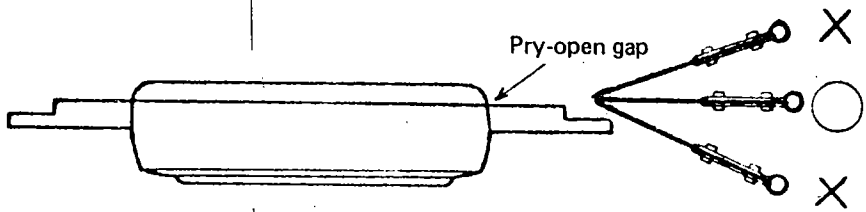
Working procedure	Illustration of working	Remarks
<p>1</p> <p>Removal of case body (only for ring A and B)</p>	<p>[Ring A]</p>  <p>Case body</p> <p>[Ring B]</p>  <p>driver</p> <p>Ring body</p> <p>Screw for ring body</p> <p>Case body</p>	<p>The two screws for ring body are removed, and then the case body is taken out.</p> <div style="border: 1px solid black; padding: 5px; margin-top: 10px;"> <p>The appearance structure of the bracelet-type watch is identical to the conventional double-part type (case back biting type).</p> </div>
<p>2</p> <p>Removal of case back (The appearance mode is described with ring B.)</p>	<p>Hereafter, the procedure is common to each model.</p>  <p>Pry-open gap</p> <p>Pry-open gaps:</p> <p>Ring type : 6-o'clock side</p> <p>Bracelet type : 9-o'clock side</p>	<p>The pry-opener is inserted horizontally into the pry-open gap and then into other areas in the same way after securing an ample space at the pry-open gap area. Then the case back is removed when it comes up horizontally.</p>

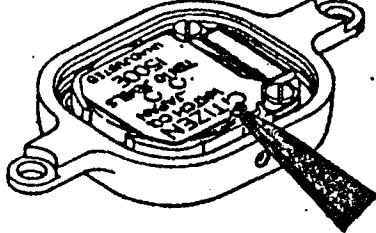
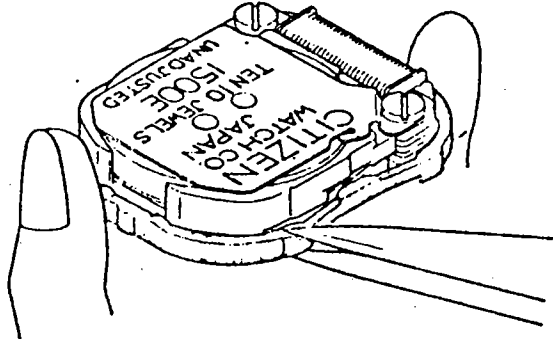



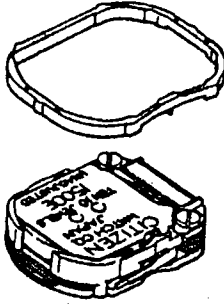
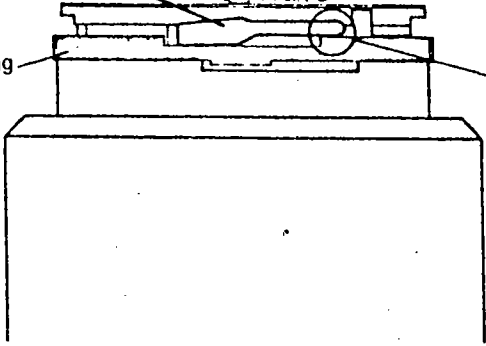
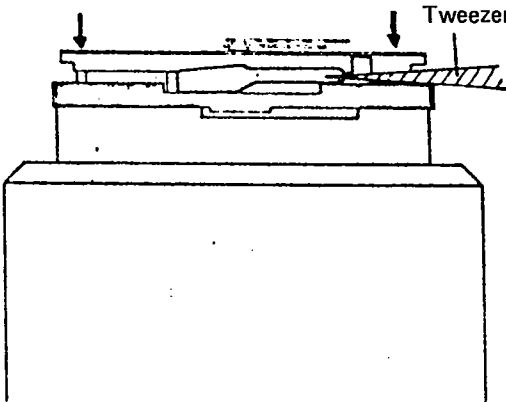

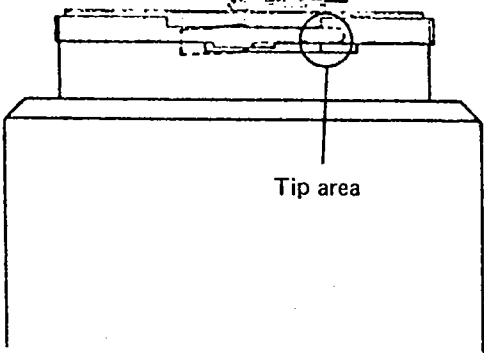
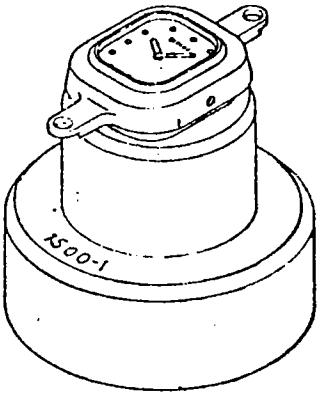

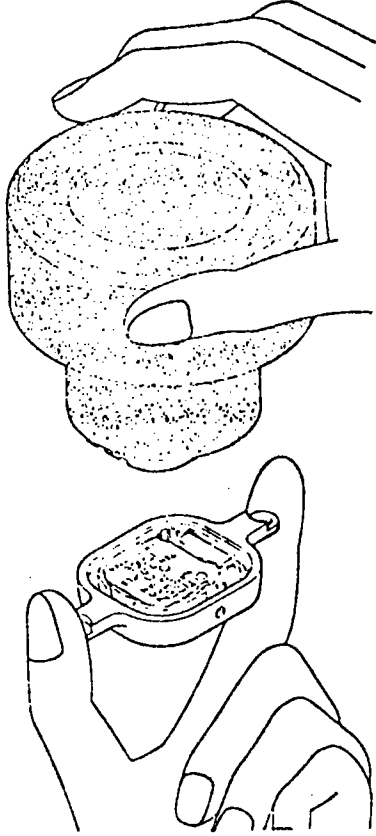
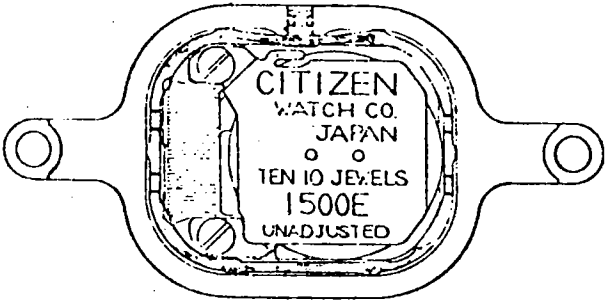

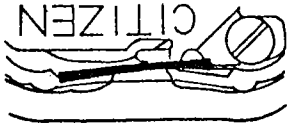
Working procedure	Illustration of working	Remarks
<p data-bbox="289 121 344 172">3</p> <p data-bbox="293 226 483 289">Detachment of movement</p>		<p data-bbox="1214 233 1507 359">Never fail to hold the movement only at the earth part of the power cell strap.</p>
<p data-bbox="289 569 344 619">4</p> <p data-bbox="293 674 505 737">Removal of casing supporter</p>		<p data-bbox="1214 583 1523 772">The movement must be held in the 11-5 o'clock direction as illustrated when using your fingers to remove the casing supporter.</p> <p data-bbox="1214 800 1528 982">The movement holder ring can also be removed while it is put on the movement holder with the dial side of the movement turned up.</p>
<p data-bbox="289 1167 344 1218">5</p> <p data-bbox="293 1272 459 1335">Detachment of hands</p>	<ol style="list-style-type: none"> <li data-bbox="578 1182 1117 1346">1) The space between hands of this caliber is small. When detaching the hands, lay a vinyl sheet or the like over the hands to avoid damaging the dial or hands. <li data-bbox="578 1367 1078 1455">2) Both the hour and minute hands are put together and pulled out at one time. <p data-bbox="578 1482 1024 1545">* Use a hand remover exclusive for Cal. No. 150 **.</p>	<p data-bbox="1227 1188 1498 1251">Avoid using again the hand once used.</p>

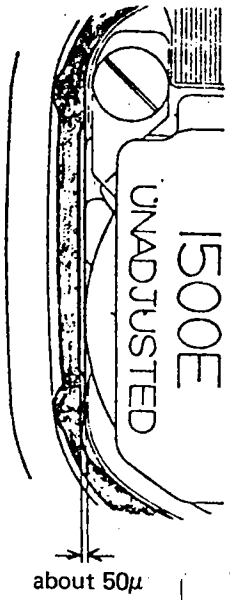
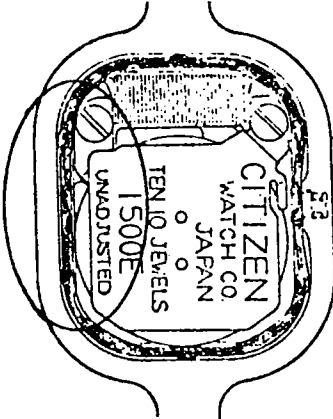
Working procedure	Illustration of working	Remarks
<p>6</p> <p>Detachment of dial</p>	<p>1) Two screws for dial are unset.</p> <p>2) The dial is detached.</p>	<p>Avoid applying the strong force to a driver when unsetting the screws. Be careful not to slip a driver to avoid giving flaws or malformation to the dial or the plate complete.</p> <p>Hold soft the hidden outer circumference area of the dial with a tweezers or the like.</p>
<p>7</p> <p>Attachment of dial</p>	<p>The two screws for dial are driven alternately after deciding an accurate center position.</p>	<p>Mind to hide the center hold of the dial since the outer diameter of the hand skirt is nearly equal to the center hole of the dial.</p>
<p>8</p> <p>Attachment of hour hand</p>	<p>The hour hand is attached to the dial after putting the power cell into the movement.</p>	<p>Make sure that the hour hand does not rub the dial at the worst.</p>
<p>9</p> <p>Attachment of minute hand</p>	<p>After attachment of the minute hand, make sure the following points.</p> <ul style="list-style-type: none"> • The minute hand does not rub neither the hour hand nor the dial. • The hands are fitted in a correct way. 	<p>The electromagnetic correction system is applied to this caliber. Thus the minute hand must be attached to the dial after advancing the time quickly up to 11:58 for instance and then setting the time at 12 o'clock with a stepped advance of time.</p>

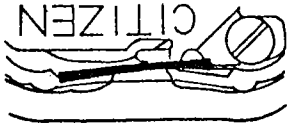
Working procedure	Illustration of working	Remarks
<p data-bbox="272 128 334 174">10</p> <p data-bbox="272 226 500 352">Attachment of movement holder ring to movement for replacement.</p>	<p data-bbox="532 128 1089 289">① The movement holder ring is attached temporarily to the movement with the side having two joggles each in the 12-6 o'clock direction turned to the case back side.</p>  <p data-bbox="532 653 1089 716">② The movement is set on the movement holder.</p> <p data-bbox="651 730 797 758">Switch spring</p> <p data-bbox="391 821 630 848">Movement holder ring</p>  <p data-bbox="532 1199 1089 1268">③ The movement is pushed in soft while the switch spring is being pressed.</p> <p data-bbox="1019 1346 1117 1373">Tweezers</p> 	<p data-bbox="1203 659 1507 751">The movement holder ring must not be pushed at this moment.</p> <p data-bbox="1203 785 1523 911">The tip of the switch spring-hits the movement holder ring to be held as it is.</p>

Working procedure	Illustration of working	Remarks
	<p>④ The condition of attachment is confirmed for the movement holder ring.</p> <p><u>Points of confirmation:</u></p> <ol style="list-style-type: none"> 1) The movement holder ring must be parallel to the surface of the plate over the entire circumference of the movement holder ring. 2) The switch spring must be covered up by the movement holder ring, or the tip of the switch spring can be seen a little from the lower side. 	<p>The confirmation is given with the movement being put on the movement holder.</p>
<p>11</p> <p>Confirmation of push-button's working</p>	<p>The push-button is pressed in the state of bezel alone to confirm whether the push-button works smooth or not. In case the smooth working is not secured for the push-button.</p> <p style="text-align: center;">↓</p> <p>The push-button must be cleaned along with clearing of the dust on the case.</p>	<p>The pushing rod for push-button is used.</p> <p>The silicone oil is applied to the O-ring of the push-button.</p>
<p>12</p> <p>Attachment of bezel</p>	<p>① The bezel is attached to the movement which is put on the movement holder.</p> 	

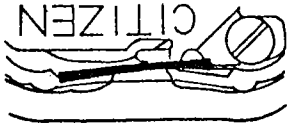
Working procedure	Illustration of working	Remarks
	<p data-bbox="565 128 1101 258">② The bezel is held by fingers, and then the movement holder is turned over to detach the bezel gently from the movement holder.</p>  <p data-bbox="574 1150 1175 1255">③ The state of attachment is confirmed through the binoculars for the movement holder ring and the movement.</p> <p data-bbox="620 1272 863 1306"><u>Points of checking:</u></p> <p data-bbox="623 1314 1195 1415">1) The steady positioning of the whole movement holder ring is confirmed at the position right above the movement.</p> 	<p data-bbox="1247 1314 1500 1377">Never fail to use the binoculars.</p> <p data-bbox="1247 1411 1484 1537">Make sure that the movement holder ring is not floating at all.</p>

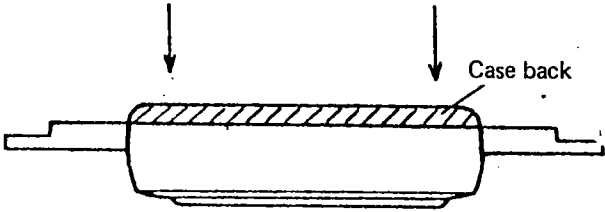

Working procedure	Illustration of working	Remarks									
	<p data-bbox="597 132 1162 258">2) The setting position between the switch spring and the movement holding ring is confirmed from upper and oblique sides.</p> <table border="1" data-bbox="607 275 1539 751"> <thead> <tr> <th data-bbox="607 275 846 338"></th> <th data-bbox="846 275 1198 338">Correct</th> <th data-bbox="1198 275 1539 338">Wrong</th> </tr> </thead> <tbody> <tr> <td data-bbox="607 338 846 537">Upside view</td> <td data-bbox="846 338 1198 537">  </td> <td data-bbox="1198 338 1539 537">  </td> </tr> <tr> <td data-bbox="607 537 846 751">Side view</td> <td data-bbox="846 537 1198 751">  </td> <td data-bbox="1198 537 1539 751">  </td> </tr> </tbody> </table> <div data-bbox="711 793 1401 1052" style="border: 1px solid black; padding: 5px; margin: 10px 0;"> <p>In the completed watch, the push-button pressures the switch spring via the movement holder ring and thus the tip (in the 2-o'clock direction) of the switch spring touches the pattern of the unit of electronic circuit. In this connection, the closing of the case back in the incomplete condition will cause the defective working of the watch.</p> </div> <p data-bbox="613 1098 1230 1224">3) Make sure that a gap of about 50μ is secured between the plate and the movement holder ring in the 9-o'clock direction of the movement.</p> <div data-bbox="412 1150 634 1745" style="display: inline-block; vertical-align: middle;">  <p style="text-align: center;">about 50μ</p> </div> <div data-bbox="857 1224 1187 1640" style="display: inline-block; vertical-align: middle; margin-left: 20px;">  </div> <div data-bbox="1279 1209 1568 1587" style="border: 1px solid black; padding: 5px; margin-left: 20px;"> <p>If the case back is closed with the movement holder ring positioned on the plate or with no gap secured between the plate and the movement holder ring the quartz crystal oscillator may be broken.</p> </div>		Correct	Wrong	Upside view			Side view			
	Correct	Wrong									
Upside view											
Side view											

Working procedure	Illustration of working	Remarks
<p>13</p> <p>Closing of case back</p>		<p>The case back is closed horizontally as much as possible to avoid the shift of the movement holder ring after fitting the notch area of the case back to the push-button area.</p>
<p>14</p> <p>Attachment of case body to ring body</p>	<p>(For ring A and only)</p> <p>The case body is attached to the ring body by referring to the illustration of working procedure 1.</p>	
<p>15</p> <p>Check of appearance & functions</p>	<ol style="list-style-type: none"> ① Make sure that no dust nor stains attach to the upper surface of the dial or the inside of the glass. ② The working of the push-button is checked with use of the pushing rod for push-button. <ul style="list-style-type: none"> · 1 push : —————> Advance of 30 sec. · Continuous push (1 sec. or more): —————> Quick advance of time ③ The time is measured by the timing machine. As this watch adapts the DFC (digital frequency control) system, the "MEASURE TIME" of the timing machine must be set to 10 sec. or its integer-fold value. 	<p>This watch has no time control terminal and thus cannot receive the time adjustment in the market.</p>

7. DISASSEMBLY/ASSEMBLY OF MOVEMENT

Disassembling procedure: ① → ⑬
 Assembling procedure: ⑬ → ①

Marks of lubrication

-  A-Lube oil
-  V-Lube oil
-  F-Lube oil

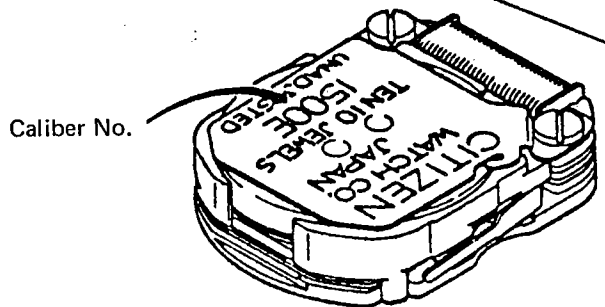
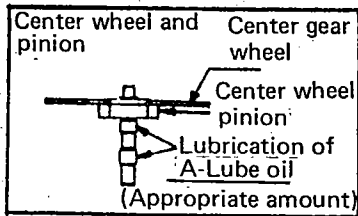
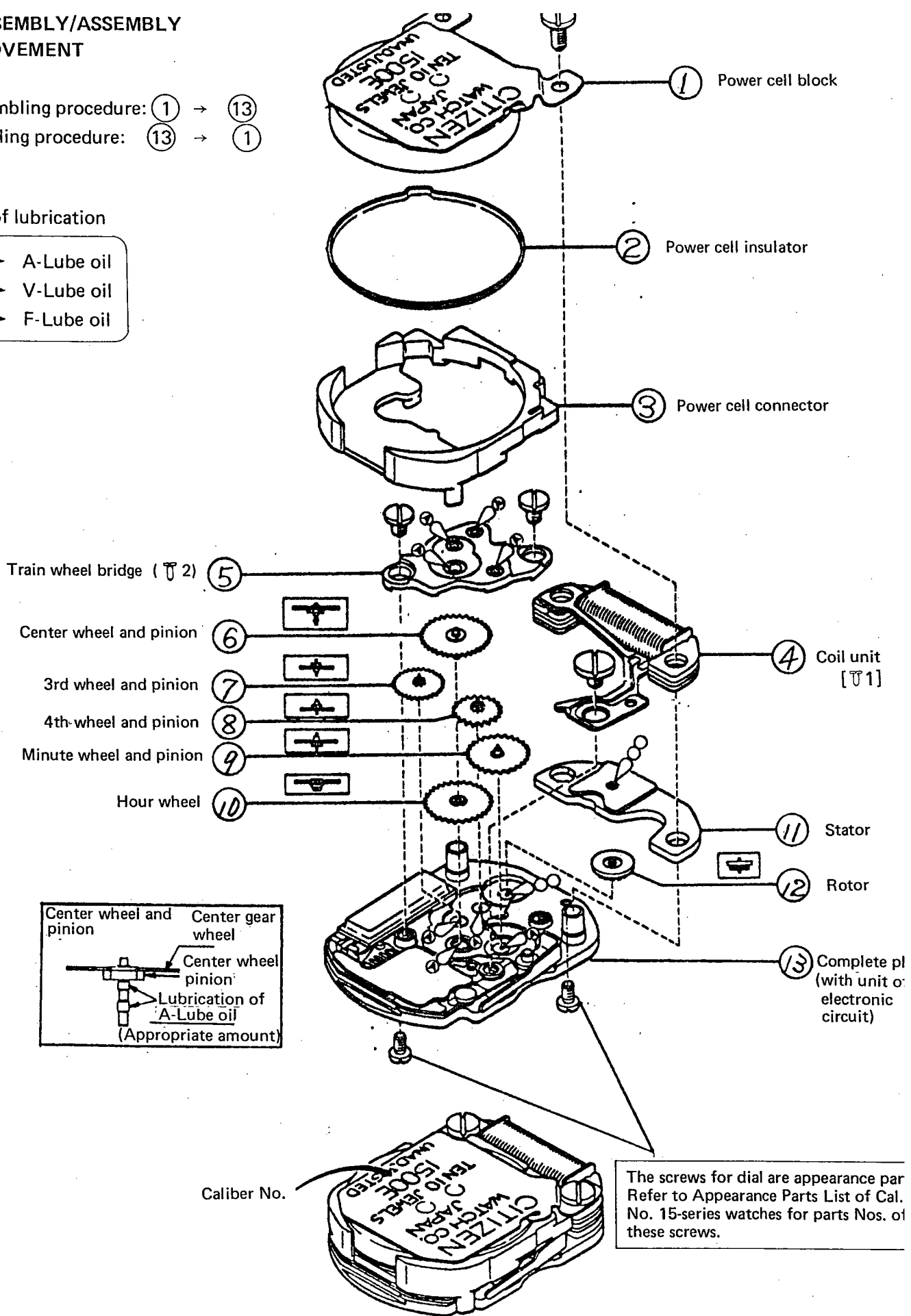

The screws for dial are appearance par
 Refer to Appearance Parts List of Cal.
 No. 15-series watches for parts Nos. of
 these screws.

- **Notes on disassembly/assembly of movement**

- 1) **Detachment of power cell block**

The power cell block is unset by holding soft with a tweezers at the area of the screw part of the power cell strap at the 3-o'clock position.

- 2) **Attachment/detachment of screw for coil**

The screw for coil is attached and detached while pressing light the upper or side surface of the power cell strap with fingers.

If the strong force is applied from upside, the exfoliation will be caused to the IC.

- 3) **A quartz crystal oscillator, the IC parts and others are mounted on a plate complete. And the warp of the plate complete, if arises, will cause the disconnection of the quartz crystal oscillator or other faults.**

In this respect, never fail to use the designated movement holder.

- 4) **The washing of the plate complete must be done by hands.**

- 5) **The hour wheel can easily be removed by pushing light the shaft of the hour wheel from the side opposite to the plate complete and with use of a tweezers. Avoid holding the tooth part of the hour wheel with strong force to prevent the malformation or damage of the teeth.**

This is due to a very small thickness of the hour wheel.

8 FLOW CHART OF TROUBLESHOOTING AND ADJUSTMENT

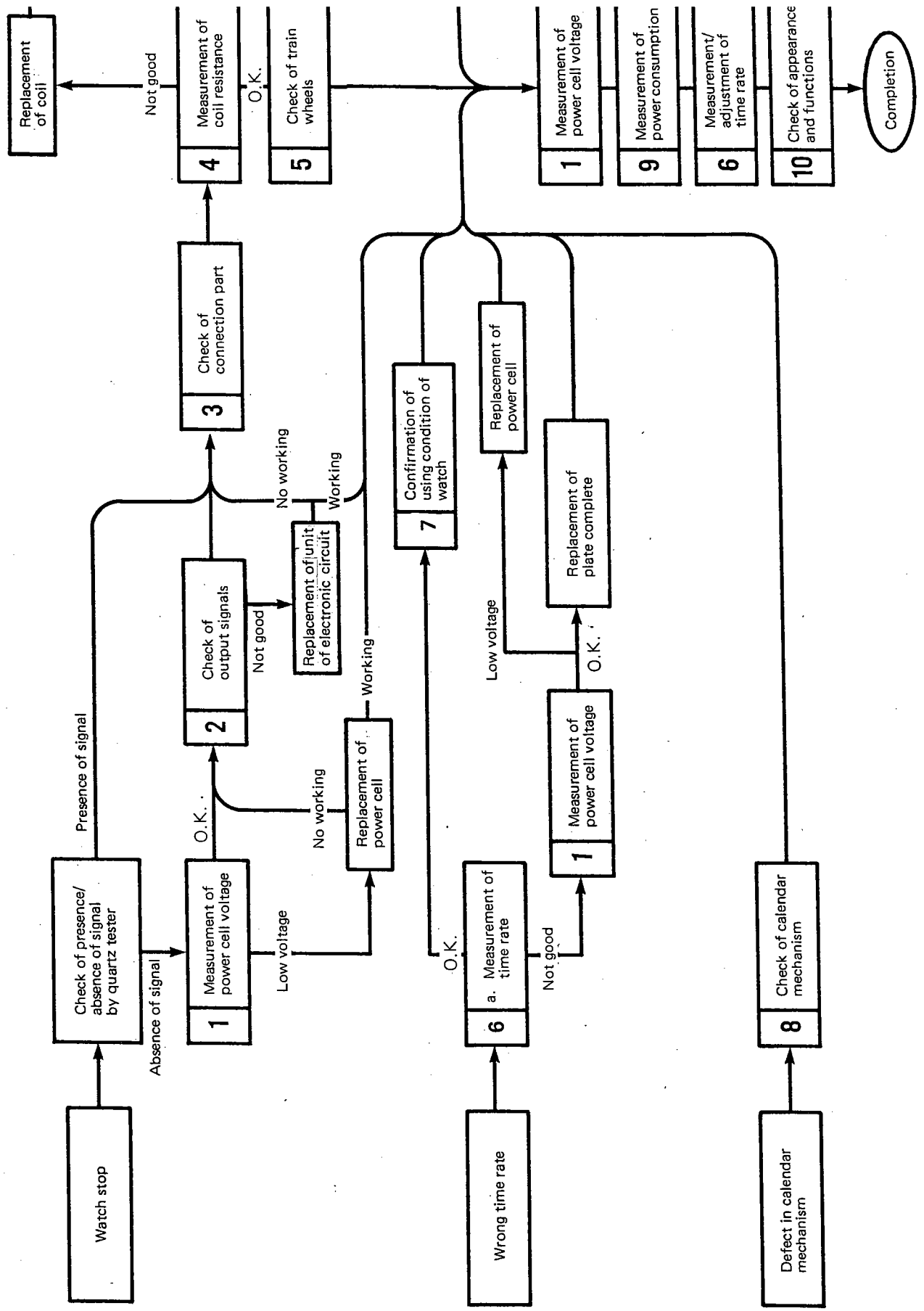

Checking items	How to check	Result & treatment
<p data-bbox="289 121 321 163">1</p> <p data-bbox="289 191 456 281">Measurement of power cell voltage</p>	<div data-bbox="711 132 987 814" style="text-align: center;"> </div> <p data-bbox="565 856 1166 1014">A contact is secured by putting the tip of a lead wire into the bottom area (+) of the power cell from this side. The minus (-) lead wire is previously applied to the movement as illustrated above.</p>	<div data-bbox="1198 128 1344 163" style="border: 1px solid black; padding: 2px;">Over 1.5V</div> <p data-bbox="1222 174 1487 201">→ Nondefective</p> <div data-bbox="1198 233 1365 268" style="border: 1px solid black; padding: 2px;">Under 1.5V</div> <p data-bbox="1222 279 1523 342">→ Replacement of power cell</p> <p data-bbox="1214 380 1287 407">Note:</p> <p data-bbox="1243 411 1549 632">If the measured watch has been used 1.5 years or longer, the power cell must be replaced with new one although the measured value is 1.5V or higher.</p>
<p data-bbox="289 1077 321 1119">2</p> <p data-bbox="289 1142 516 1266">Check of 512 Hz oscillation of quartz crystal oscillator</p>	<p data-bbox="573 1077 1117 1108">Refer to attached "Check by Oscilloscope".</p>	

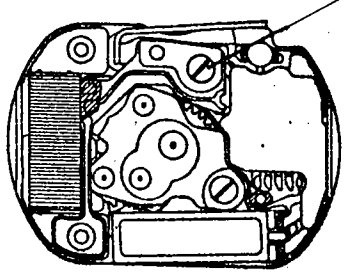
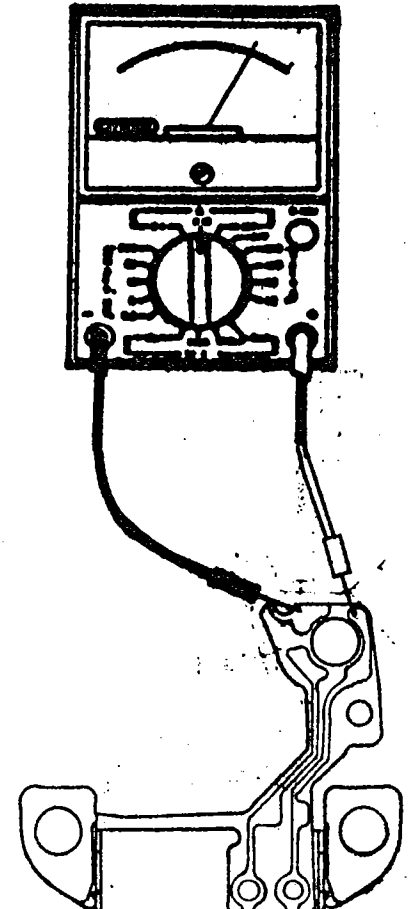
Checking items	How to check	Result & treatment
<p>3</p>	<ul style="list-style-type: none"> Make sure that the connection part between the coil terminal sheet and the unit of electronic circuit is free from dust or stains. Make sure that the screw for connection of coil terminal sheet is driven tight. <p style="text-align: right;">Screw for connection of coil terminal sheet</p> 	<p>Dust or stains → To be cleared away</p> <p>Incomplete driving of screw → To be driven tight</p>
<p>4</p> <p>Measurement of coil resistance</p>		<p>1.6 ~ 2.2 kΩ → Nondefective</p> <p>Outside the above range of resistance → Replacement of coil unit</p> <p>* The pattern of the coil connection terminal sheet has a difference of level, and this area must be held by a Rodico or the like when measuring the coil resistance.</p>

Checking items	How to check	Result & treatment
<div data-bbox="250 117 337 174" style="border: 1px solid black; padding: 2px; width: fit-content;">5</div> <p data-bbox="282 197 483 321">Check of train wheels (incl. minute wheel & hour wheel)</p>	<ol style="list-style-type: none"> <li data-bbox="553 197 1094 359">1) Make sure that a proper clearance is secured for each wheel. (Rotor 10 ~ 40 μ : Center, 3rd & 4th wheels plus minute/hour wheels 20 ~ 40 μ) <li data-bbox="553 390 1024 453">2) Make sure that the lubrication is appropriate to each wheel. <li data-bbox="553 485 1122 548">3) Make sure that each wheel is completely free from dust or stains. <div data-bbox="613 583 1138 835" style="text-align: center;"> <p style="font-size: small;">3rd wheel Center wheel Rotor 4th wheel Minute wheel</p> </div>	<p data-bbox="1203 197 1495 359">Break of gears due to inappropriate clearance → Replacement of train wheel bridge or broken gears</p> <p data-bbox="1203 390 1495 485">Inappropriate lubrication → Lubrication again</p> <p data-bbox="1203 516 1446 611">Dust or stains → To be cleared away</p>
<div data-bbox="250 884 337 940" style="border: 1px solid black; padding: 2px; width: fit-content;">6</div> <p data-bbox="282 963 461 1026">Measurement of time rate</p>	<p data-bbox="553 963 1127 1058">The unit time of measurement must be set at "10 sec." or an integerfold period of time of 10 sec. owing to the DFC method.</p> <p data-bbox="553 1121 1154 1247">If a big error is detected in the time rate owing to an impact or the like factor, the plate complete must be replaced with new one since this caliber applies the DFC method.</p>	<p data-bbox="1203 963 1487 1089">Normal time rate → Confirmation of using condition of watch</p>
<div data-bbox="250 1297 337 1354" style="border: 1px solid black; padding: 2px; width: fit-content;">7</div> <p data-bbox="282 1377 469 1503">Confirmation of using condition of watch</p>	<p data-bbox="553 1377 1118 1472">The using condition of a watch must be confirmed with its user about the following points.</p> <ol style="list-style-type: none"> <li data-bbox="553 1493 1175 1556">1) Whether or not the user handled the watch in a wrong way. <li data-bbox="553 1577 1135 1671">2) Whether or not the user used the watch outside its effective range of temperature. <li data-bbox="553 1692 1127 1755">3) How many days passed since the latest adjustment of time rate ? <li data-bbox="553 1776 1138 1839">4) Other factors related to the handling of watch. 	

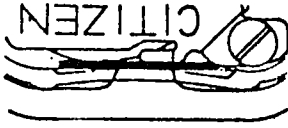
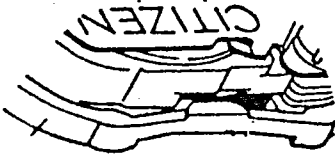
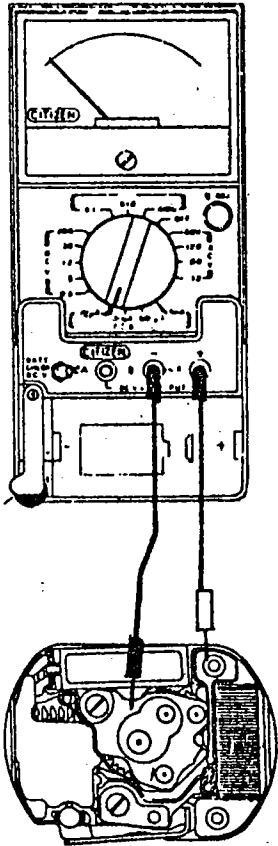
Checking.items	How to check	Result & treatment
<p data-bbox="272 117 321 163">8</p> <p data-bbox="272 184 477 247">Check of switch mechanism</p>	<ol style="list-style-type: none"> <li data-bbox="548 184 1081 247">1) Make sure that the switch spring is set in a correct way. <li data-bbox="548 317 1105 411">2) Make sure that the push-button and the area around the switch spring are free from dust or stains. <li data-bbox="548 447 1105 541">3) Make sure that the push-button and the switch spring are free from any malformation and break. <p data-bbox="548 604 1081 667">* Never fail to apply the silicone oil when replacing or cleaning the push button.</p> <ul style="list-style-type: none"> <li data-bbox="548 699 971 730">· Correct setting of switch spring <div style="display: flex; justify-content: space-around; align-items: center;"> <div data-bbox="548 814 837 940">  </div> <div data-bbox="959 800 1292 953">  </div> </div> <p data-bbox="586 978 756 1010">(Upside view)</p> <p data-bbox="1049 978 1187 1010">(Side view)</p>	<p data-bbox="1195 184 1479 279">Defective setting of switch spring → To be set again</p> <p data-bbox="1195 317 1463 411">Dust or stains → To be cleared away</p> <p data-bbox="1195 447 1479 604">Malformation or break of push-button or switch spring → Repair or replacement</p>
<p data-bbox="272 1045 321 1092">9</p> <p data-bbox="272 1102 488 1186">Measurement of power consumption</p>	<div style="text-align: center;">  </div>	<p data-bbox="1211 1108 1474 1182">Under $0.4\mu A$ → Nondefective</p> <p data-bbox="1211 1213 1511 1339">Over $0.4\mu A$ → Measurement of circuit power consumption</p> <ul style="list-style-type: none"> <li data-bbox="1211 1371 1528 1434">· Measurement of circuit power consumption <li data-bbox="1211 1444 1487 1570">Under $0.2\mu A$ → Washing & lubrication of movement <li data-bbox="1211 1581 1511 1675">Over $0.2\mu A$ → Replacement of plate complete <p data-bbox="1211 1686 1601 1917">* The power consumption value of this caliber is small compared with other calibers, and thus the tester's amplitude is very small. So take the meticulous care to read out the measured value.</p>

Checking items	How to check	Result & treatment
<div data-bbox="228 107 321 163" style="border: 1px solid black; padding: 2px; width: fit-content;">10</div> <p data-bbox="256 184 435 279">Check of appearance & function</p>	<p data-bbox="526 191 1029 254">The following points are checked with a complete watch.</p> <ol style="list-style-type: none"> <li data-bbox="526 275 1008 338">1) The push-button can be operated in a correct and smooth way. <li data-bbox="526 359 1065 422">2) The area of each function is free from dust or stains. <p data-bbox="526 453 1073 558">* Refer to 15 (Check of appearance & function) of 6. (Appearance Disassembly/Assembly). — Page 6.</p>	

Plate complete

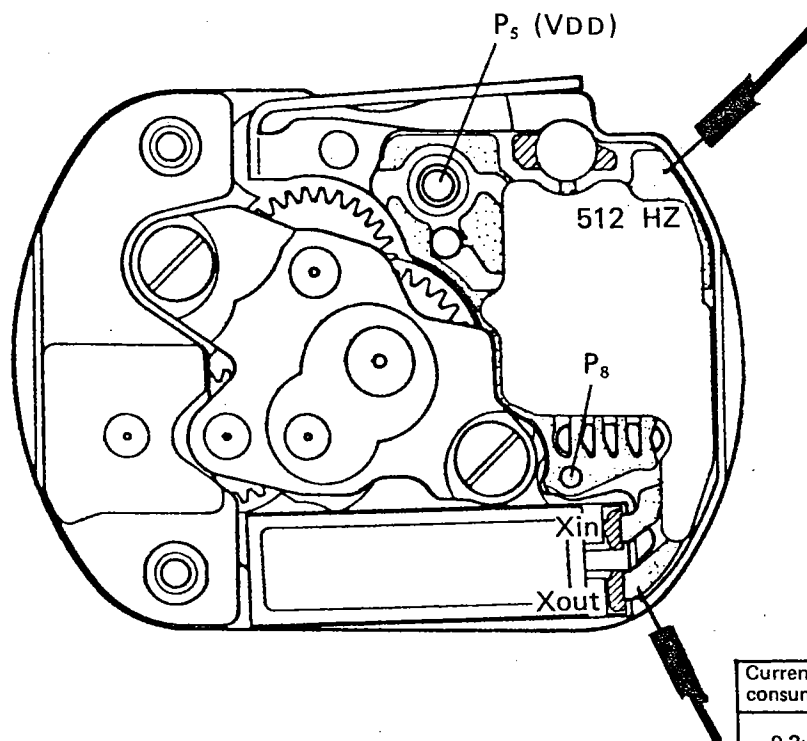

Current consumption	Element at Xin side	Element at Xout side
0.2μA		

Waveform of quartz crystal oscillation

512 HZ

Waveform diagram

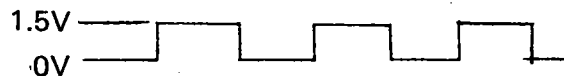
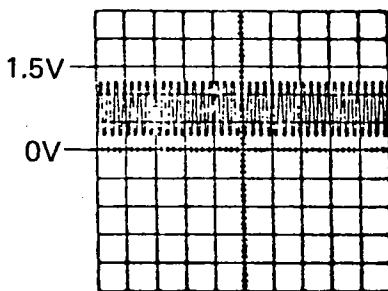

Notes

1. Check the state of conduction (presence or absence of crack) on both the upper and lower surfaces of the unit of electronic circuit by means of a binocular microscope since P₅ (VDD) of the unit of electronic circuit is a through hole.
2. Make sure that the area P₈ of the unit of electronic circuit is free from any exfoliation of solder.
3. The areas around Xin and Xout are coated, and make sure that these areas are free from cracks.